

STATUS IN NHSSCOTLAND
BEST PRACTICE GUIDANCE

Health Building Note 00-02
Core elements:
Sanitary spaces

For queries on the status of this document contact
nss.hfsenquiries@nhs.net or telephone 0141207 1600
Status Note v2 amended 24th March 2017

Health Building Note 00-02 – Sanitary spaces

This document must be read in conjunction with current Scottish Government Policy and NHSScotland Guidance, which take precedence. These include publications in both: www.sehd.scot.nhs.uk/ and www.hfs.scot.nhs.uk/publications/.

Specific updates for NHSScotland use:

This guidance must be read in conjunction with the public sector equality duty in the Equality Act 2010 and the Specific Duties (Scotland) Regulations 2012. These state named Scottish public authorities, including NHSScotland, must have 'due regard' to the need to eliminate unlawful discrimination, advance equality of opportunity and foster good relations. This requires an integrated response across services, facilities, training and communications to ensure the characteristics protected by the Act are appropriately served. An Equality Impact Assessment (EIA) is required for all proposed investments. Scottish Capital Investment Manual's NHSScotland Design Assessment Process will also support the implementation of this public sector equality duty at key business case stages of the facility design process.

Update since last issue: new section 5.74 Changing Places facility, and reference to detailed design and registration requirements, which are available from www.changing-places.org.

Changing Places facilities are primarily for public not clinical use, as are general accessible toilets, their functions should not normally be combined. The quantity and location for both should be considered for all new public investment under an Equality Impact Assessment (EIA). It is anticipated that the population of Scotland served by majority of NHSScotland campuses, would require a Changing Places facility, as well as general accessible toilets, baby changing, gender neutral facilities, together with inclusive, dementia and age appropriate design inside and out.



Department
of Health

Core elements

Health Building Note 00-02: Sanitary spaces

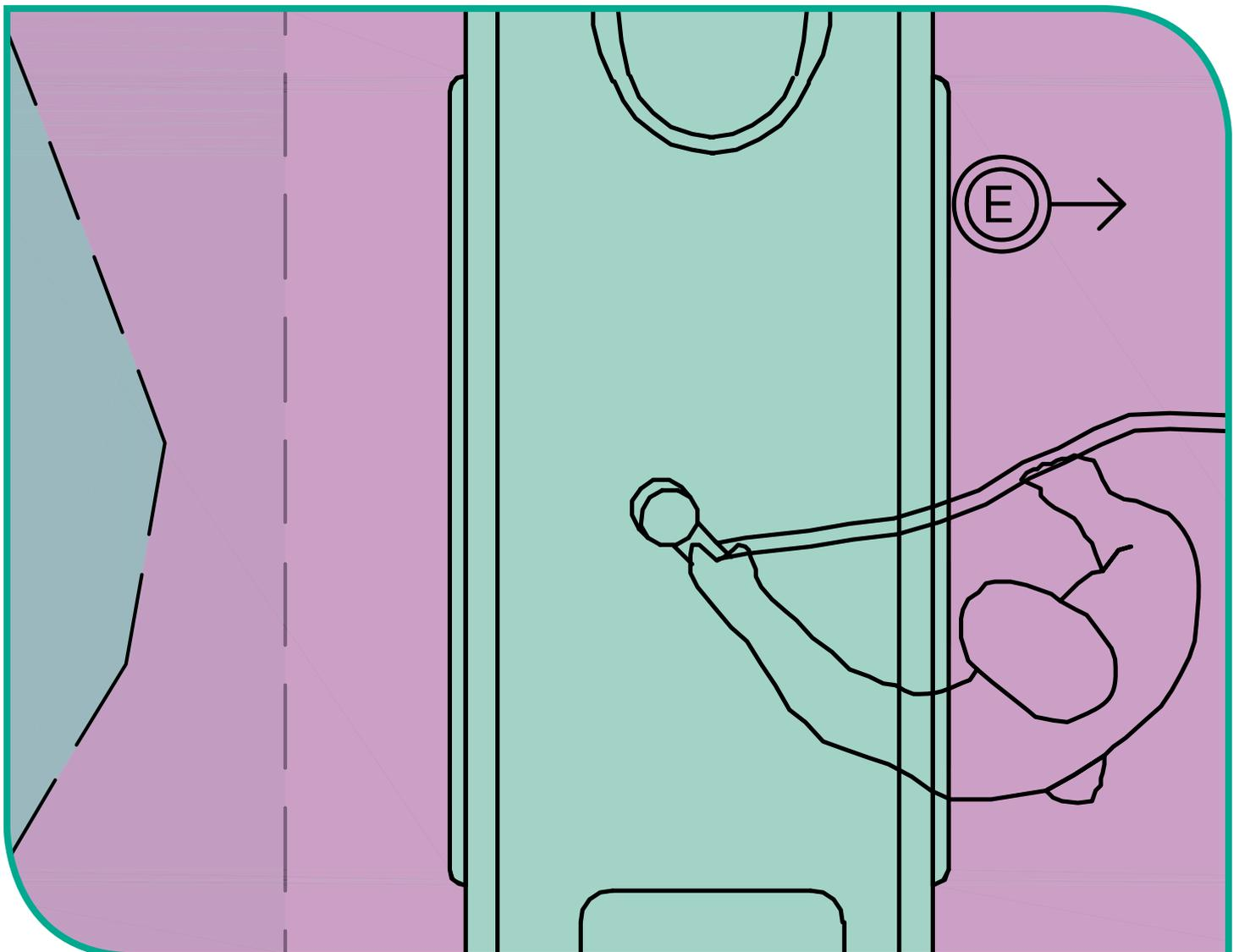

Core elements

Health Building Note 00-02:
Sanitary spaces

© Crown copyright 2016

You may re-use this information (not including logos) free of charge in any format or medium under the terms of the Open Government Licence. To view this licence, visit www.nationalarchives.gov.uk/doc/open-government-licence/ or write to the Information Policy Team, The National Archives, Kew, London TW9 4DU, or email: psi@nationalarchives.gsi.gov.uk.

This document is available from our website at <https://www.gov.uk/government/collections/health-building-notes-core-elements>

Preface

About Health Building Notes

Health Building Notes give “best practice” guidance on the design and planning of new healthcare buildings and on the adaptation/extension of existing facilities.

They provide information to support the briefing and design processes for individual projects in the NHS building programme.

The Health Building Note suite

Healthcare delivery is constantly changing, and so too are the boundaries between primary, secondary and tertiary care. The focus now is on delivering healthcare closer to people’s homes.

The Health Building Note framework (shown below) is based on the patient’s experience across the spectrum of care from home to healthcare setting and back, using the national service frameworks (NSFs) as a model.

Health Building Note structure

The Health Building Notes have been organised into a suite of 17 core subjects.

Care-group-based Health Building Notes provide information about a specific care group or pathway but cross-refer to Health Building Notes on **generic (clinical) activities** or **support systems** as appropriate.

Core subjects are subdivided into specific topics and classified by a two-digit suffix (-01, -02 etc), and may be further subdivided into Supplements A, B etc.

All Health Building Notes are supported by the overarching Health Building Note 00 in which the key areas of design and building are dealt with.

Example

The Health Building Note on accommodation for adult in-patients is represented as follows:

“Health Building Note 04-01: Adult in-patient facilities”

The supplement to Health Building Note 04-01 on isolation facilities is represented as follows:

“Health Building Note 04-01: Supplement 1 – Isolation facilities for infectious patients in acute settings”

Health Building Note number and series title	Type of Health Building Note
Health Building Note 00 – Core elements	Support-system-based
Health Building Note 01 – Cardiac care	Care-group-based
Health Building Note 02 – Cancer care	Care-group-based
Health Building Note 03 – Mental health	Care-group-based
Health Building Note 04 – In-patient care	Generic-activity-based
Health Building Note 05 – Older people	Care-group-based
Health Building Note 06 – Diagnostics	Generic-activity-based
Health Building Note 07 – Renal care	Care-group-based
Health Building Note 08 – Long-term conditions/long-stay care	Care-group-based
Health Building Note 09 – Children, young people and maternity services	Care-group-based
Health Building Note 10 – Surgery	Generic-activity-based
Health Building Note 11 – Community care	Generic-activity-based
Health Building Note 12 – Out-patient care	Generic-activity-based
Health Building Note 13 – Decontamination	Support-system-based
Health Building Note 14 – Medicines management	Support-system-based
Health Building Note 15 – Emergency care	Care-group-based
Health Building Note 16 – Pathology	Support-system-based

Other resources in the DH Estates and Facilities knowledge series

Health Technical Memoranda

Health Technical Memoranda give comprehensive advice and guidance on the design, installation and operation of specialised building and engineering technology used in the delivery of healthcare (for example medical gas pipeline systems, and ventilation systems).

They are applicable to new and existing sites, and are for use at various stages during the inception, design, construction, refurbishment and maintenance of a building.

All Health Building Notes should be read in conjunction with the relevant parts of the Health Technical Memorandum series.

Activity DataBase (ADB)

The Activity DataBase (ADB) data and software assists project teams with the briefing and

design of the healthcare environment. Data is based on guidance given in the Health Building Notes, Health Technical Memoranda and Health Technical Memorandum Building Component series.

1. Room data sheets provide an activity-based approach to building design and include data on personnel, planning relationships, environmental considerations, design character, space requirements and graphical layouts.
2. Schedules of equipment/components are included for each room, which may be grouped into ergonomically arranged assemblies.
3. Schedules of equipment can also be obtained at department and project level.
4. Fully loaded drawings may be produced from the database.
5. Reference data is supplied with ADB that may be adapted and modified to suit the users' project-specific needs.

How to obtain publications

Health Building Notes are available from the UK Government's website at:

<https://www.gov.uk/government/collections/health-building-notes-core-elements>

Health Technical Memoranda are available from the same site at:

<https://www.gov.uk/government/collections/health-technical-memorandum-disinfection-and-sterilization>.

Executive Summary

Health Building Note 00-02 – ‘Sanitary spaces’ provides evidence-based best practice guidance on the design and layout of sanitary spaces for use in healthcare settings.

Room sizes have been standardised wherever possible. For areas where a standard room size is not appropriate, this document provides a sizing methodology suitable for briefing purposes. Most of the indicative room layouts are informed by one or more ergonomic drawings.

In places, the guidance differs from that provided in Approved Document M (2010) and BS 8300:2001 (2009 edition). Where this is the case, the reasons for the variations are discussed.

Contents

Preface	iii
About Health Building Notes	
The Health Building Note suite	
Health Building Note structure	
Other resources in the DH Estates and Facilities knowledge series	
Health Technical Memoranda	
Health Technical Memorandum Building Component series	
Activity DataBase (ADB)	
How to obtain publications	
Executive summary	v
1 Introduction	1
Purpose and scope of this document	
Principle of using generic rooms wherever possible	
Standardised room sizes	
Evidence base	
2 Bathrooms	3
Bathroom with bidet: semi-ambulant	
Room description and layout	
Ergonomic drawings	
Bathroom: assisted	
Bathroom: assisted	
Ergonomic drawings	
Bathroom: independent wheelchair	
Room description and layout	
Ergonomic drawings	
Bathroom: semi-ambulant	
Room description and layout	
Ergonomic drawings	
3 Changing facilities	29
Changing area: staff	
Room description and layout	
Ergonomic drawings	

Changing room: independent wheelchair

Room description and layout

Ergonomic drawings

Changing room: semi-ambulant

Room description and layout

Ergonomic drawings

Nappy changing room

Room description and layout

Uniform exchange area

Room description and layout

4 Shower rooms 43

Shower room: ambulant

Room description and layout

Ergonomic drawings

Shower room: assisted

Room description and layout

Ergonomic drawings

Shower room: en-suite: chamfered

Room description and layout

Ergonomic drawings

Shower room: en-suite

Room description and layout

Ergonomic drawings

Shower room: independent wheelchair

Room description and layout

Shower room: semi-ambulant: standing use

Room description and layout

Ergonomic drawings

Shower room: trolley access

Room description and layout

Ergonomic drawings

Shower room: trolley access: private use

Room description and layout

Ergonomic drawings

5 WCs.....84

- WC: ambulant
 - Room description and layout
 - Ergonomic drawings
- WC: assisted
 - Room description and layout
 - Ergonomic drawings
- WC: independent wheelchair/semi-ambulant
 - Room description and layout
 - Ergonomic drawings
- WC: semi-ambulant
 - Rooms description and layout
 - Ergonomic drawings
- WC: independent wheelchair
 - Room description and layout
 - Ergonomic drawings
- WC: ‘changing places’
 - Room description and layout

References.....103

1 Introduction

1.1 Health Building Note 00-02 provides design guidance and indicative room layouts of sanitary spaces in healthcare buildings.

Purpose and scope of this document

1.2 Most of the layouts are informed by one or more ergonomic drawings (the colour-coding on the room layouts relates to ergonomic information). Both the ergonomic drawings and indicative room layouts aim to enable spaces to be designed that are fit for purpose, accessible, safe and secure.

1.3 The indicative room layouts represent example design solutions, not specific recommendations. Actual requirements should be determined on an individual project basis.

1.4 Although primarily applicable to new buildings, the recommendations contained within this guidance should also be applied, where practical, when existing facilities are being upgraded.

Principle of using generic rooms wherever possible

1.5 Generic rooms are designed to accommodate a range of activities rather than being tailored for a single function/specialty or narrow range of functions.

1.6 Sanitary spaces should be generic wherever possible to maximise flexibility in use. Generic rooms make up a high proportion of the sanitary spaces within healthcare buildings.

Standardised room sizes

1.7 The size (and dimensions) of the indicative room layouts have been standardised wherever possible. This may mean sizing up to some extent, but results in rooms that can be adapted (for alternative use) much more easily.

1.8 For areas where a standard room size is not appropriate, this document provides a sizing methodology suitable for briefing purposes.

1.9 Where special departmental requirements warrant a variation from the spaces described in this document, information is provided in the relevant guidance.

Evidence base

1.10 This document is based on the professional opinion of healthcare planning and design experts and ergonomic research (published and unpublished).

Grab rails

1.11 Grabrails are referenced extensively throughout this guidance. They are used to provide support and stability when transferring horizontally, sitting down and standing up, and while adjusting clothing. They should allow for a firm grip whether wet or dry.

1.12 Horizontal, vertical and hinged grabrails should be installed to allow users to choose the rail most appropriate for their needs. The grabrail positions on the drawings provided are generally in accordance with Approved Document M unless stated otherwise.

1.13 Hinged grabrails should lock in the vertical position, but be easy to unlock with one hand. Hinged grabrails should be capable of use with:

- vertical weight of 88 kg+50% = 132 kg; and
- a horizontal force of 155 Newtons (N) +50% = 233 N

1.14 Where appropriate grabrails may be used in place of (and to act as) towel rails.

Use of colour

1.15 Adequate colour contrast can help a visually impaired person identify features and appliances in toilets. The colour of the appliances themselves is unimportant, white being perfectly acceptable, providing they are set against a background which contrasts adequately.

1.16 When using toilets there is often a need to identify features more quickly than would be the case if undertaking a simple navigation task to get around. As such the differences in colour and tones used to contrast appliances with their backgrounds should be greater than for other circumstances.

1.17 Wherever possible the lighting to toilet areas should offer good overall illuminance and the use of highly reflective glazed tiles should be avoided.

1.18 Smaller items such as grabrails, soap dispensers and dryers should be provided against a background which affords them adequate contrast.

1.19 Wall mirrors which are placed inside the toilet, directly opposite the entrance door, can cause confusion for visually impaired people when understanding the space they have just entered or when trying to determine the layout and location of facilities. Therefore, they should be avoided.

2 Bathrooms

Bathroom with bidet: semi-ambulant

Room description and layout

2.1 See Figure 1. The following activities take place in semi-ambulant bathrooms with bidets:

- undressing and dressing;
- hanging/holding clothes;
- use of the toilet;
- use of the bidet;
- personal washing;
- use of the bath.

2.2 Semi-ambulant bathrooms should contain a bath, semi-ambulant toilet, bidet and ambulant wash-hand basin.

2.3 Bidets should be fitted with a sensor-operated over-rim supply.

2.4 Bidets are not considered appropriate for independent wheelchair users because of the difficulty in transferring between the wheelchair, toilet and bidet.

2.5 Semi-ambulant bathrooms with bidets are also suitable for ambulant users.

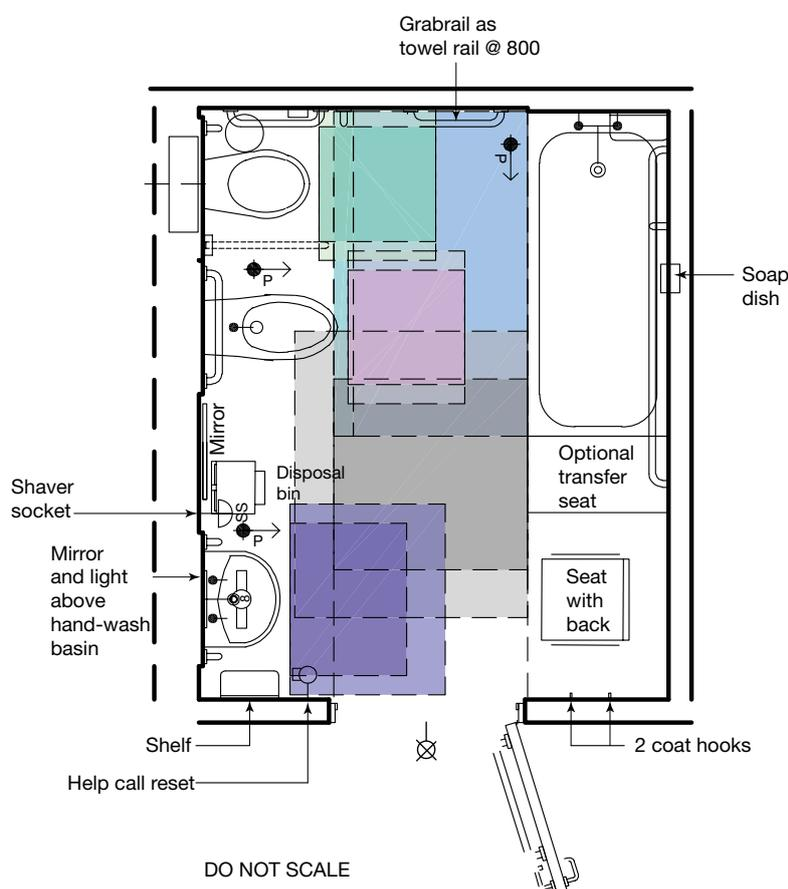

Figure 1 Space requirements for bidet: semi-ambulant

Dressing and undressing: ambulant

2.7 These ergonomic drawings (see Figure 3) show the space requirements for ambulant dressing and undressing.

2.8 An identical space provision is suitable for semi-ambulant users though it should be located adjacent to a seating area.

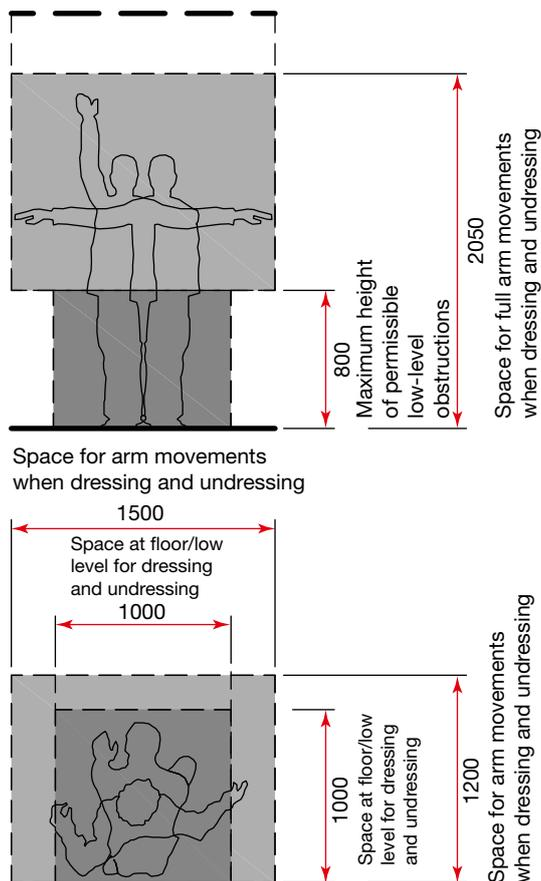

Figure 3 Space requirements for ambulant dressing and undressing

Toilet: semi-ambulant

2.9 This ergonomic drawing (see Figure 4) shows the space requirements for a semi-ambulant toilet.

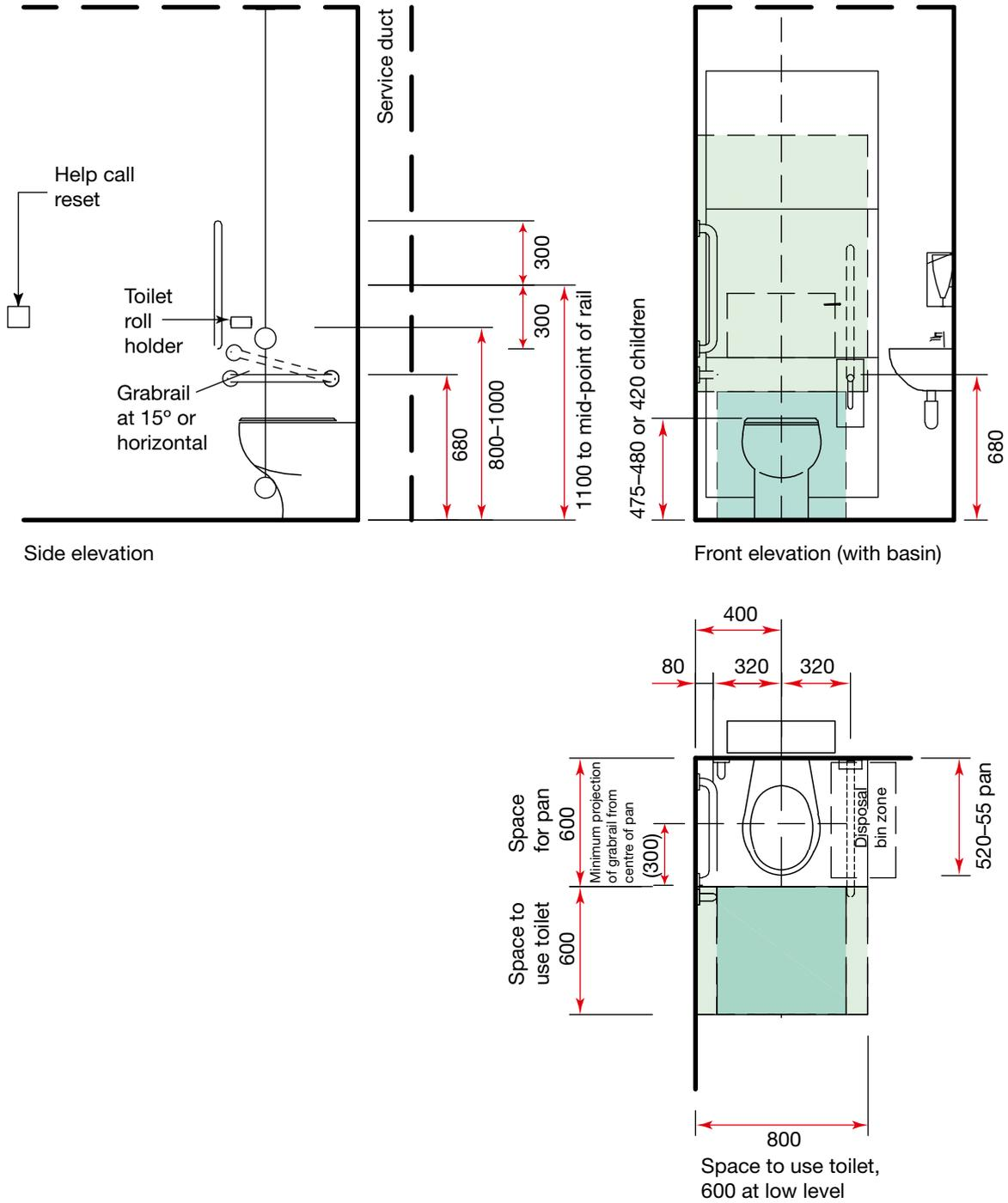

Figure 4 Space requirements to access a semi-ambulant toilet

Wash-hand basin: ambulant

2.10 Wash-hand basins may be used for personal washing activities.

2.11 This ergonomic drawing (see Figure 5) shows the space requirements for ambulant/semi-ambulant use of a 400 mm deep x 500 mm wide wash-hand basin.

2.12 It includes a shaver socket adjacent to the wash-hand basin and a light above the mirror;

these are optional. The inclusion of a shaver socket depends on project requirements. The need for a local light depends on the overall lighting scheme within the room.

2.13 The drawing also shows two short lever taps. Alternatively a single mixer tap or sensor-operated taps may be used. See Health Building Note 00-10 Part C – ‘Sanitary assemblies’ for details.

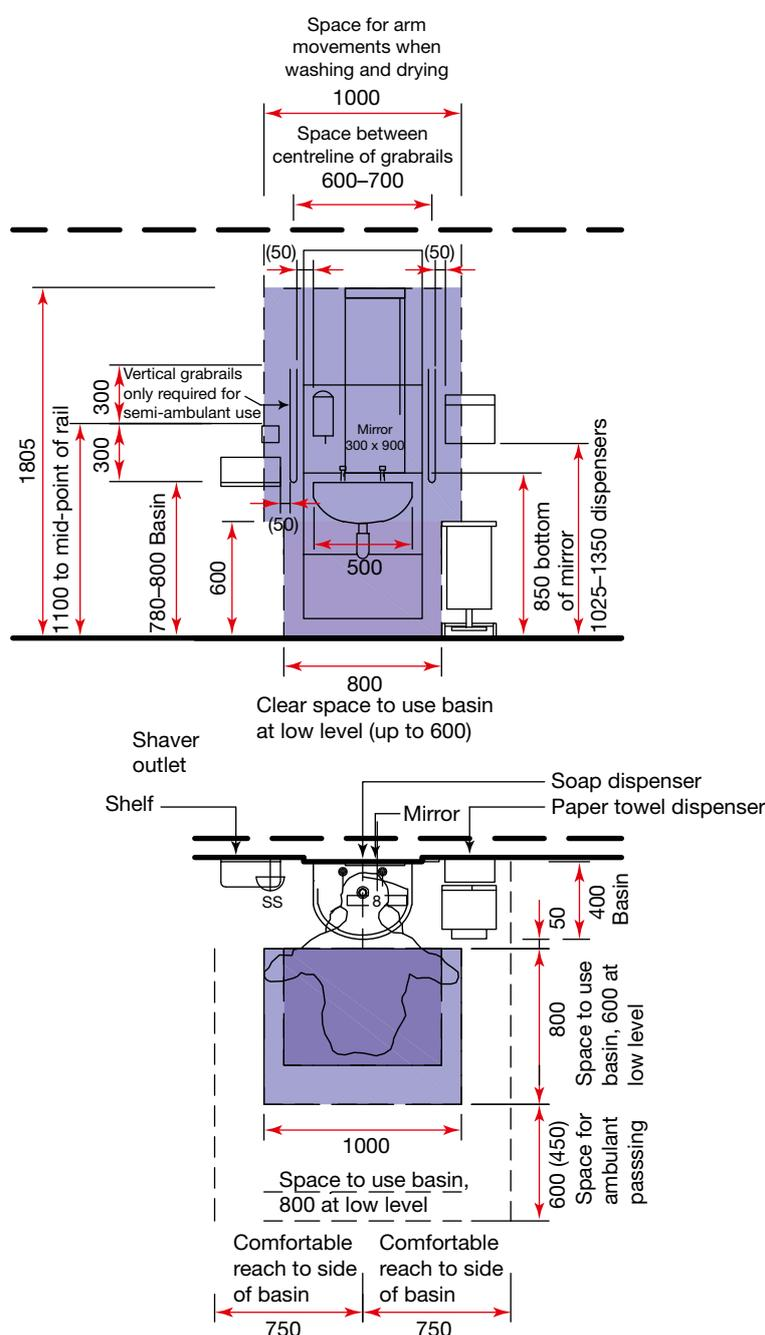

Figure 5 Space requirements for ambulant/semi-ambulant use of a 400 mm deep x 500 mm wide wash-hand basin

Full-length mirror: standing or seated users

2.14 This ergonomic drawing (see Figure 6) shows the space requirements for a full-length mirror for standing or seated users.

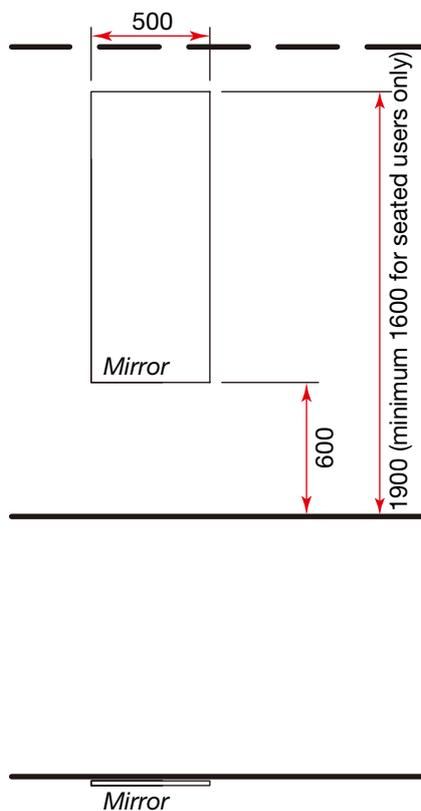

Figure 6 Space requirements to full-length mirror for standing or seated users

Bath: semi-ambulant

2.15 This ergonomic drawing (see Figure 7) shows the space requirements for a semi-ambulant bath.

2.16 Where a fixed transfer seat is not provided at the foot of the bath, an independent use bath hoist (chair) should be available, of the

type that can be securely fixed to the bath rim when required. Manufacturers' advice should be sought regarding space requirements for such bath hoists.

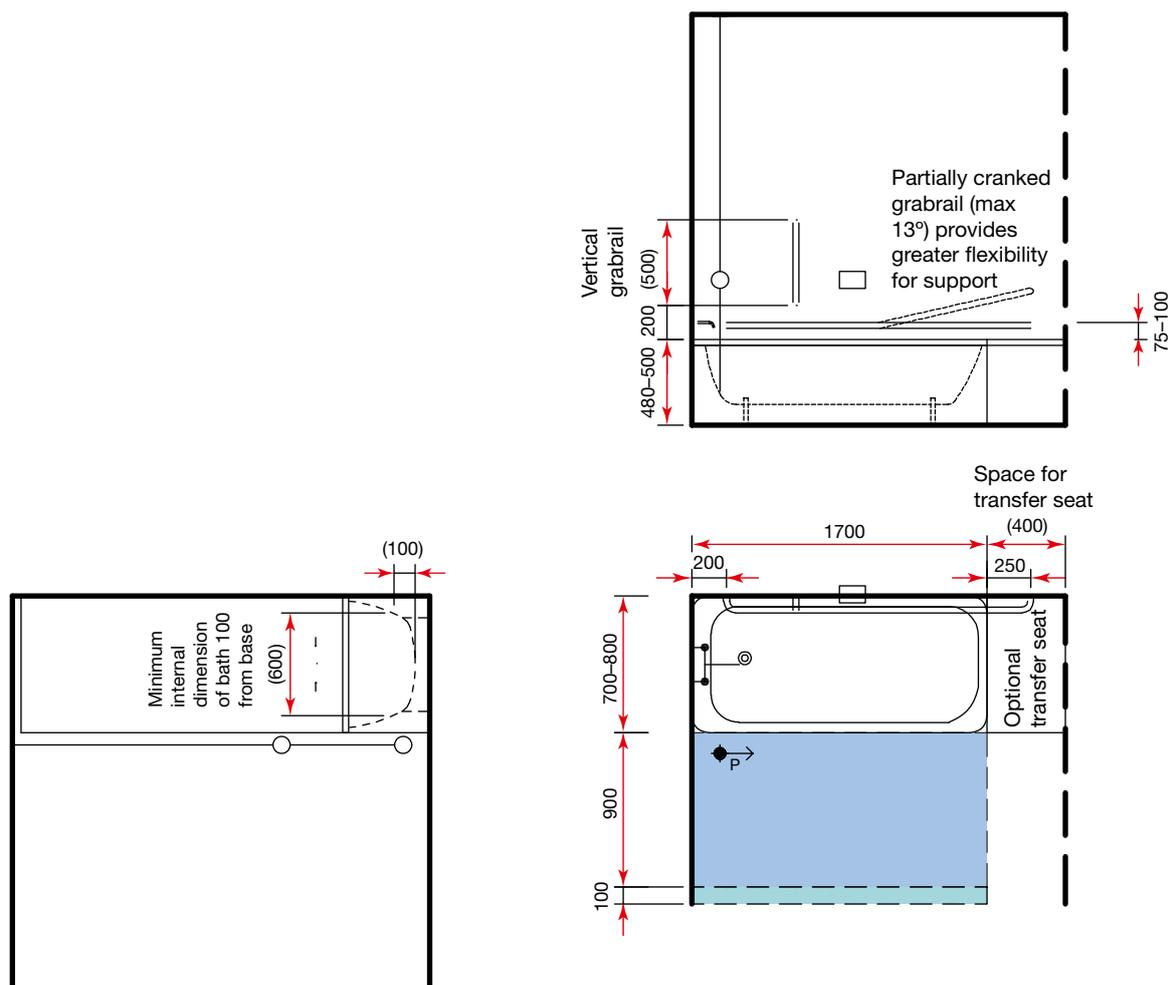

Figure 7 Space requirements to access a semi-ambulant bath

Bathroom: assisted

Bathroom: assisted

2.17 The following assisted activities take place in assisted bathrooms (end access to bath):

- undressing and dressing;
- hanging/holding clothes;
- wheelchair and sanitary chair access to the toilet and wash-hand basin;
- mobile hoist access to transfer a patient to the toilet or bath or to attend to a patient collapsed on the floor;
- patient transfer from a wheelchair to the toilet (supervised only);
- use of the toilet;
- personal washing (whilst seated);
- use of the bath.

2.18 An assisted bathroom should contain an adjustable-height bath, assisted toilet and wheelchair wash-hand basin.

2.19 Assisted variable-height baths are available in a large variety of sizes and are not covered by 'Element 4: Sanitary assemblies'. The room layout provided is based on a variable height bath measuring 800 mm wide and 2400 mm long.

2.20 The bath should be positioned in the centre of the room to provide increased access for users and staff.

2.21 Assisted bathrooms are not suitable for independent wheelchair users, and are of limited use for ambulant and semi-ambulant use without due consideration of bath access requirements and the use of an adjustable-height wash-hand basin for standing users.

2.22 The room layout (see [Figure 8](#)) utilises the minimum clear space requirement to the side of the toilet for mobile hoist transfer (that is, 1150 mm from the centreline of the toilet to the nearest obstruction), on the bath side of the toilet only.

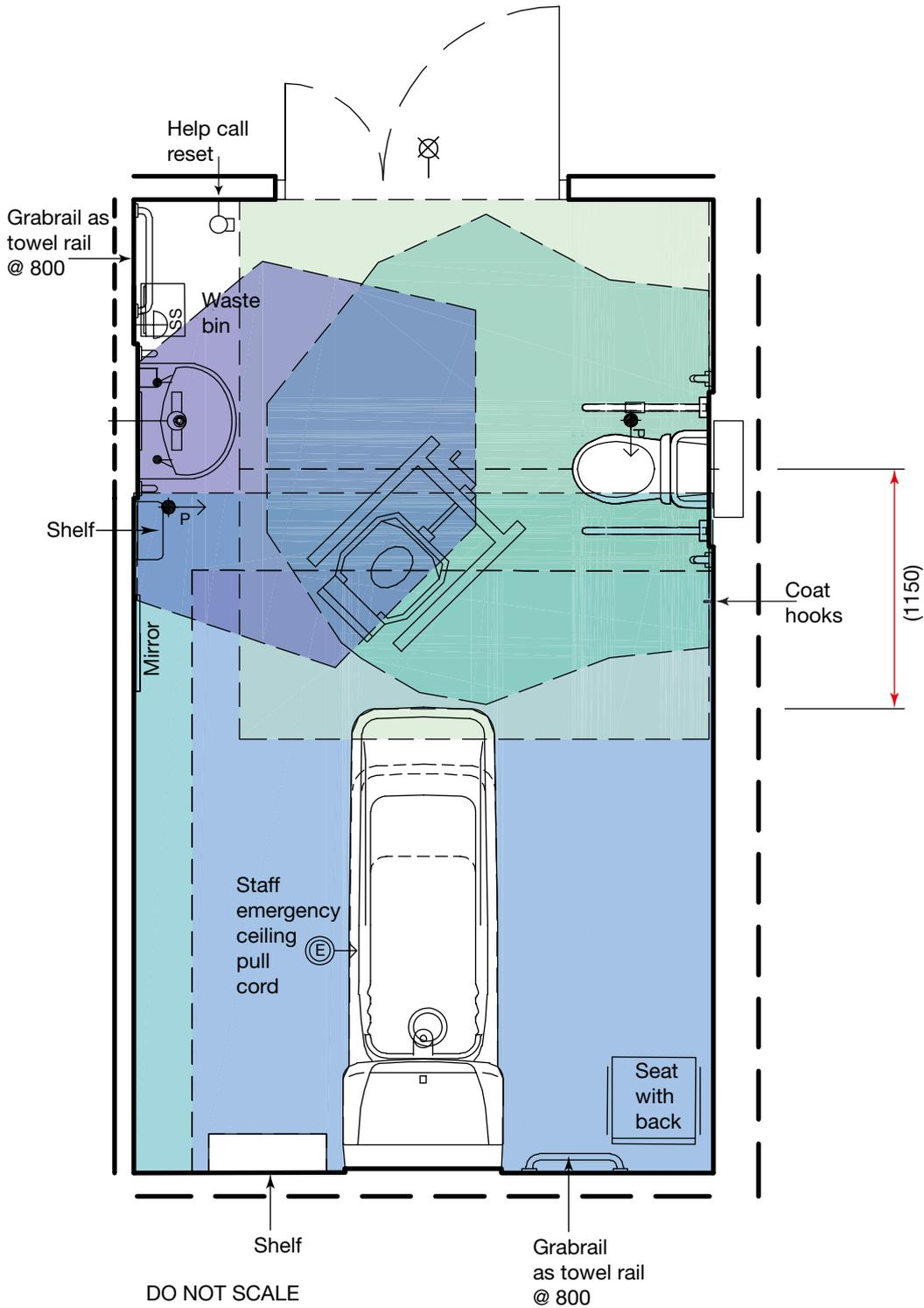

Figure 8 Space requirements for bathroom: assisted

Ergonomic drawings

Assisted bath

2.23 This ergonomic drawing (see Figure 9) shows the space requirements for an assisted bath.

2.24 Variable-height baths vary considerably in size and service requirements depending on the model and manufacturer. Specialist/manufacturer advice should be sought at the earliest possible stage to clarify requirements.

2.25 Where used as a treatment bathroom, medical gases should be provided at the head of the bath, and the model of bath should allow for the use of a stretcher hoist.

2.26 This is generic briefing information, and manufacturers' advice should be sought on the specific requirements of baths and associated lifting aids.

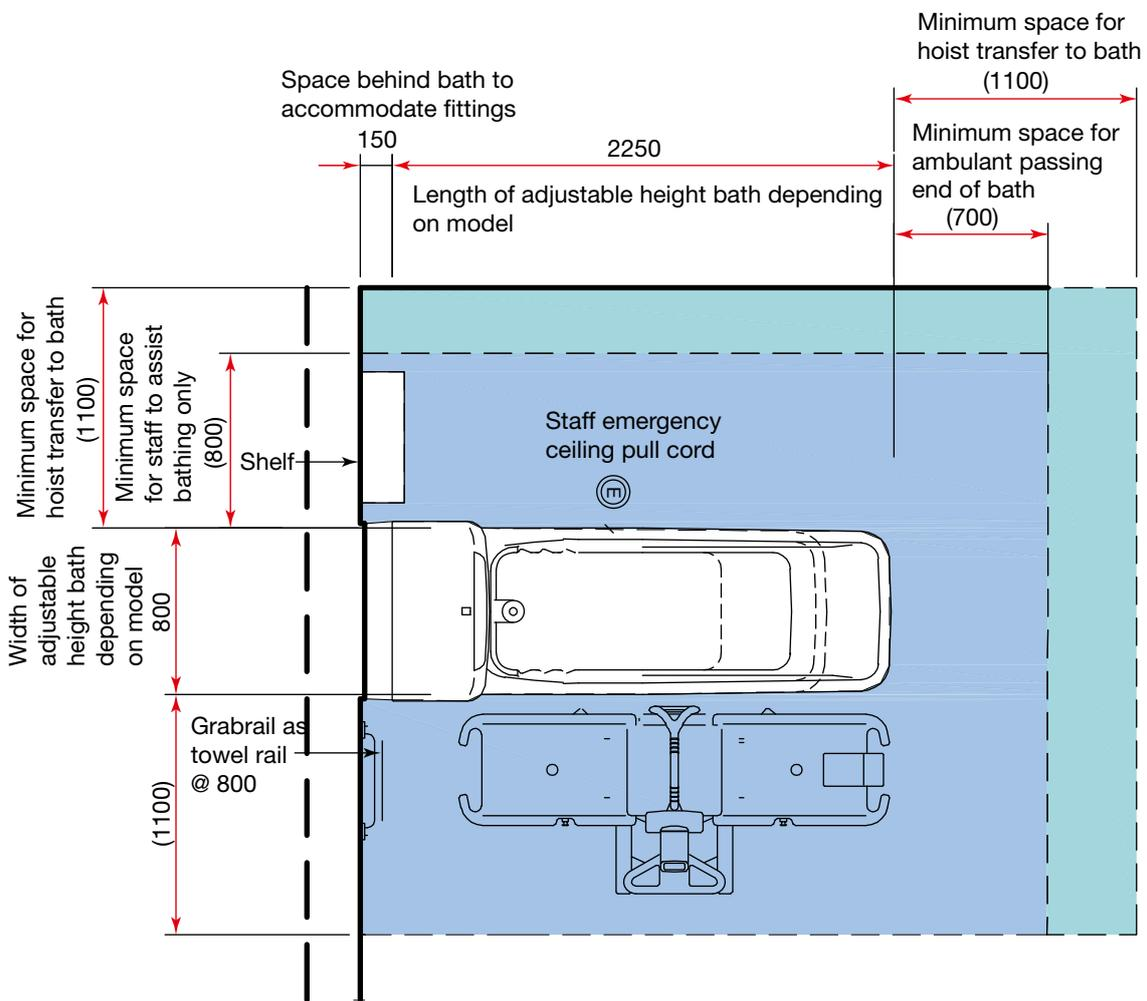

Figure 9 Space requirements to access an assisted bath

Toilet: assisted

2.27 This ergonomic drawing (see Figure 10) shows the space requirements for an assisted toilet.

2.28 The clear space on either side of the toilet for mobile hoist transfer is greater than that recommended in BS 8300 (Figure 55).

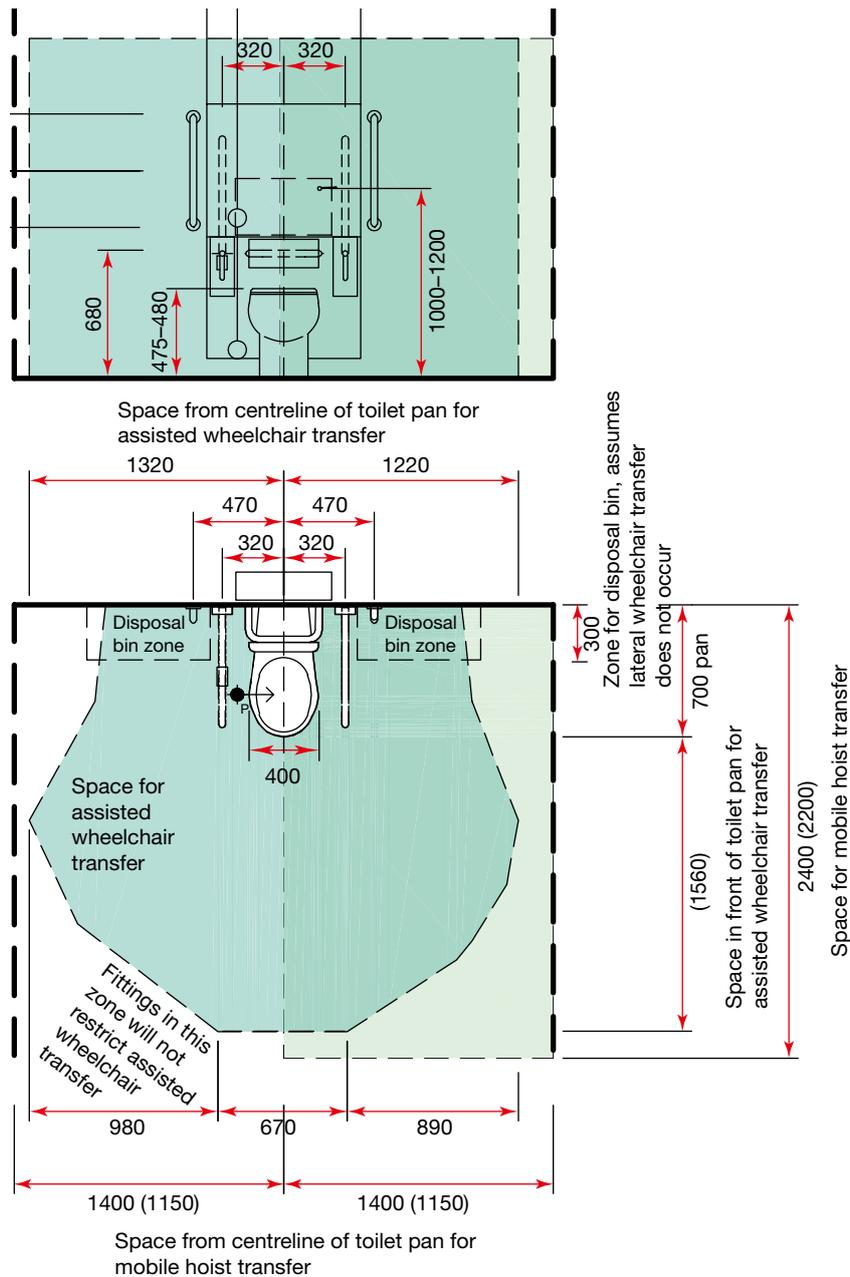

Figure 10 Space requirements to access an assisted toilet

Full-length mirror: standing or seated users

2.29 This ergonomic drawing (see Figure 11) shows the space requirements for a full-length mirror for standing or seated users.

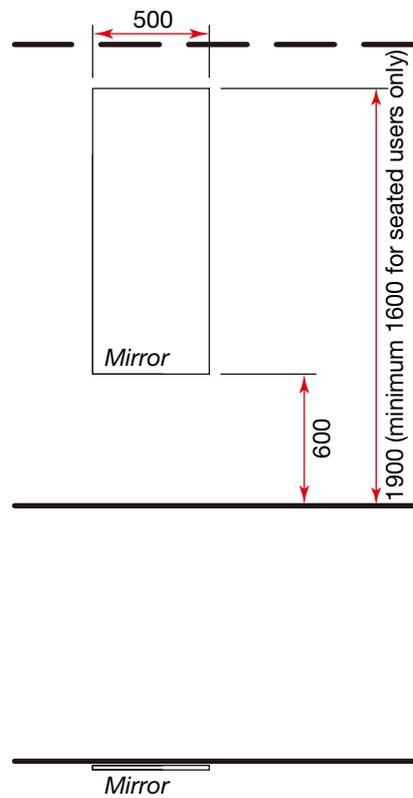

Figure 11 Space requirements for a full-length mirror for standing or seated users

Wash-hand basin: wheelchair

2.30 Wash-hand basins may be used for personal washing activities.

2.31 This ergonomic drawing (see Figure 12) shows the space requirements for a wheelchair accessible wash-hand basin. It is also suitable for seated use.

2.32 It includes a shaver socket adjacent to the wash-hand basin and a light above the mirror; these are optional. The inclusion of a shaver socket depends on project requirements. The need for a local light depends on the overall lighting scheme within the room.

2.33 The drawing also shows two short lever taps. Alternatively a single mixer tap or sensor-operated taps may be used. See Health Building Note 00-10 Part C – ‘Sanitary assemblies’ for details.

2.34 Wheelchair-accessible wash-hand basins should have a size and profile that maximises access and reduces obstructions. They should:

- be as shallow as possible, that is, tapered from the rim to a depth not exceeding 250 mm at the outlet, which in turn should be positioned as near the supporting wall as possible;
- preferably project 500 mm in order to provide adequate leg room underneath the basin.

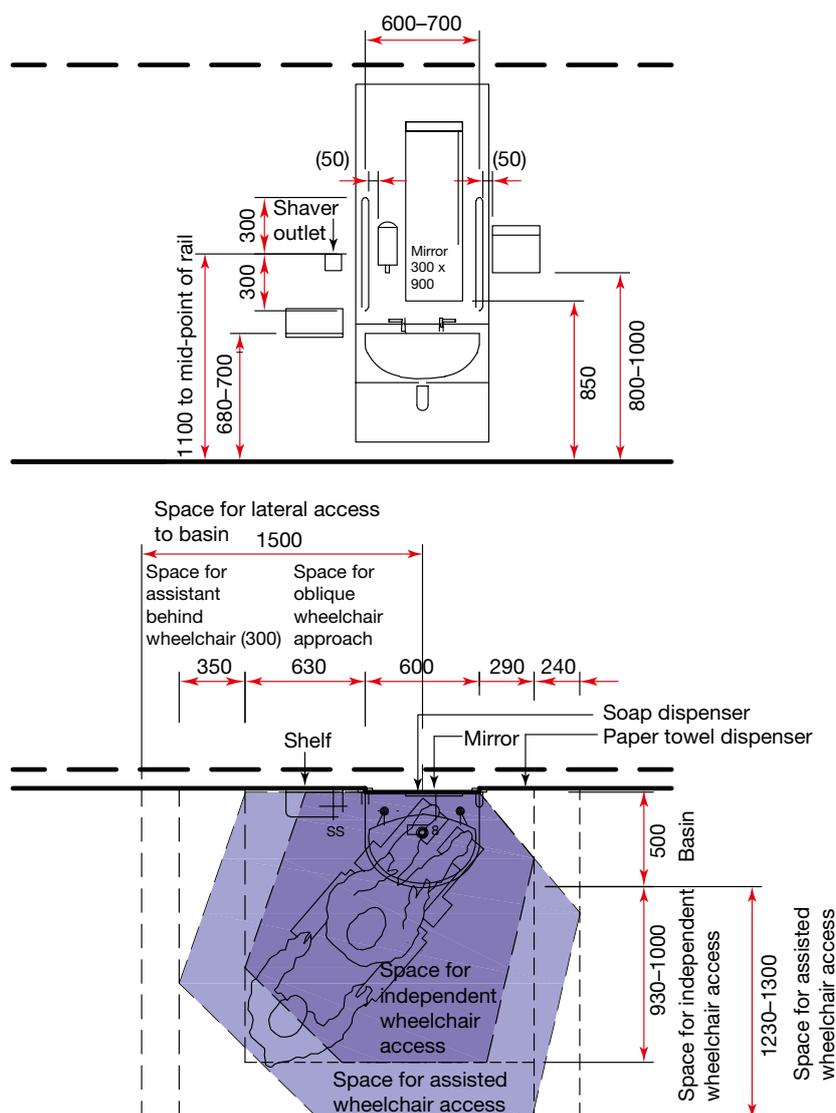

Figure 12 Space requirements for a wheelchair accessible wash-hand basin

Bathroom: independent wheelchair

Room description and layout

2.35 The following activities take place in independent wheelchair bathrooms:

- undressing and dressing;
- hanging/holding clothes;
- wheelchair access to the toilet, hand-rinse basin, wash-hand basin and bath;
- independent transfer from a wheelchair to the toilet or bath;
- use of the toilet;
- disposal of sanitary towels (optional);
- emptying of urine bottles and colostomy bags;
- hand-rinsing (whilst in a wheelchair facing the hand-rinse basin or seated on the toilet);
- personal washing (whilst seated);
- use of the bath.

2.36 Bathrooms for independent wheelchair use should contain an independent wheelchair toilet and adjacent hand-rinse basin, separate wheelchair wash-hand basin for personal washing and an independent wheelchair bath.

2.37 The example layout provided (see [Figure 13](#)) conflicts with the equivalent space in Approved Document M and BS 8300.

2.38 The layouts of independent wheelchair bathrooms in Approved Document M (Diagrams 24 and 25) and BS 8300 ([Figure 45](#)) show a wash-hand basin adjacent to the toilet. This is based on the assumption that users will fill the basin before sitting at the toilet (since the taps may be out of reach) to be able to wash their hands from a seated position on the toilet. This is not considered acceptable in healthcare premises, and hence a separate wash-hand basin has been included within the room (in addition to the hand-rinse basin adjacent to the toilet).

2.39 The example layout allows for right-hand independent wheelchair transfer to the toilet and bath.

2.40 To enable this space to be suitable for all unassisted use, an adjustable-height wash-hand basin may be provided in place of the wheelchair wash-hand basin.

2.41 Additional space may be required for special baths.

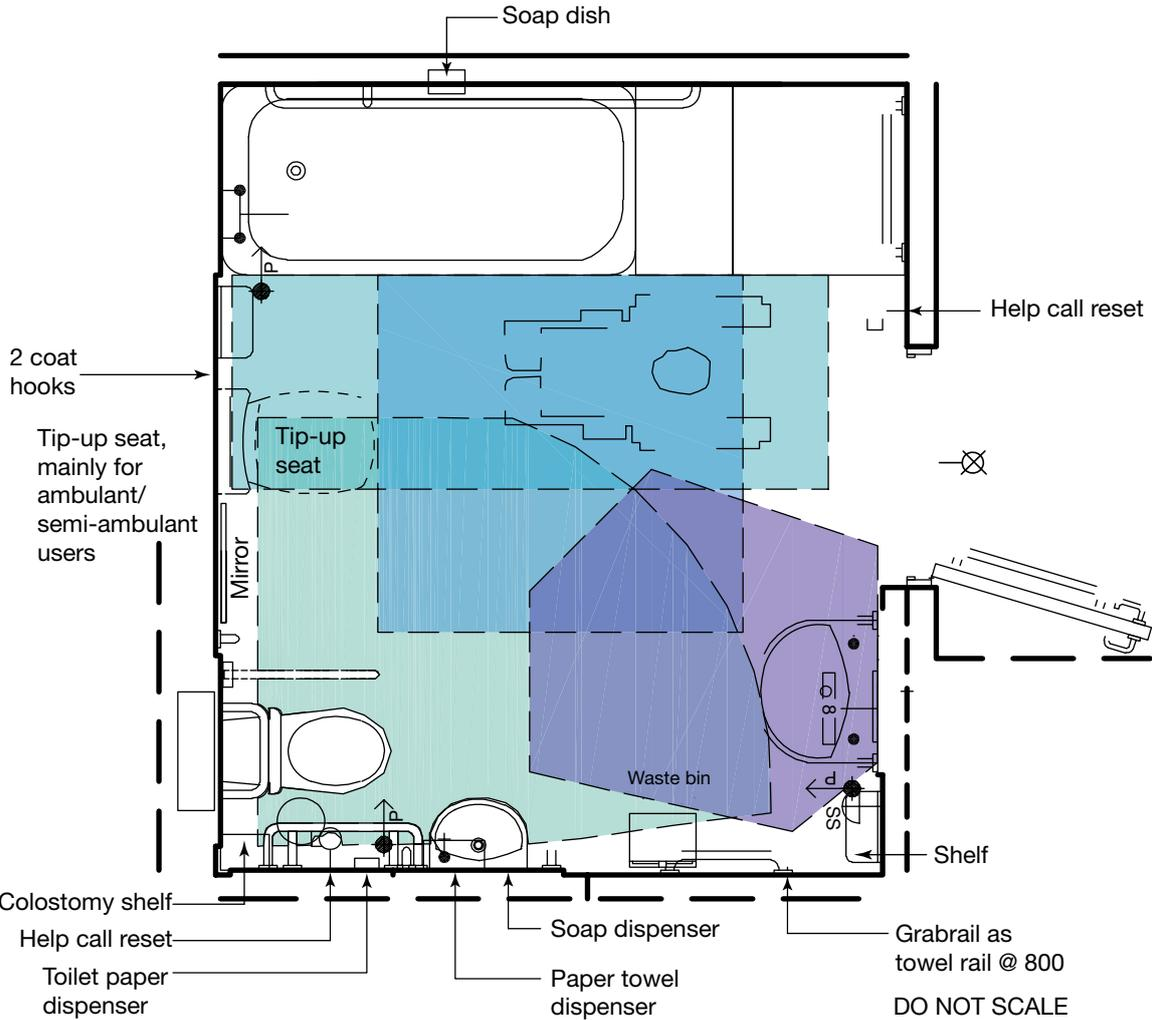

Figure 13 Space requirements to access bathroom: independent wheelchair

Ergonomic drawings

Bath: independent wheelchair

2.42 This ergonomic drawing (see Figure 14) shows the space requirements for an independent wheelchair bath.

2.43 Note the bath and fixings are similar to the bath for semi-ambulant use except for the tap location.

2.44 Wall-mounted taps (compliant with ‘Health Building Note 00-10 Part C – Sanitary assemblies’) should be provided for reasons

of infection control (rather than the corner deck-mounted taps shown in BS 8300). The taps should be located close to the edge of the bath to allow access to the taps for a wheelchair user.

2.45 Where a fixed transfer seat is not provided at the foot of the bath, an independent use bath hoist (chair) should be available, of the type that can be securely fixed to the bath rim when required. Manufacturers’ advice should be sought regarding space requirements for such bath hoists.

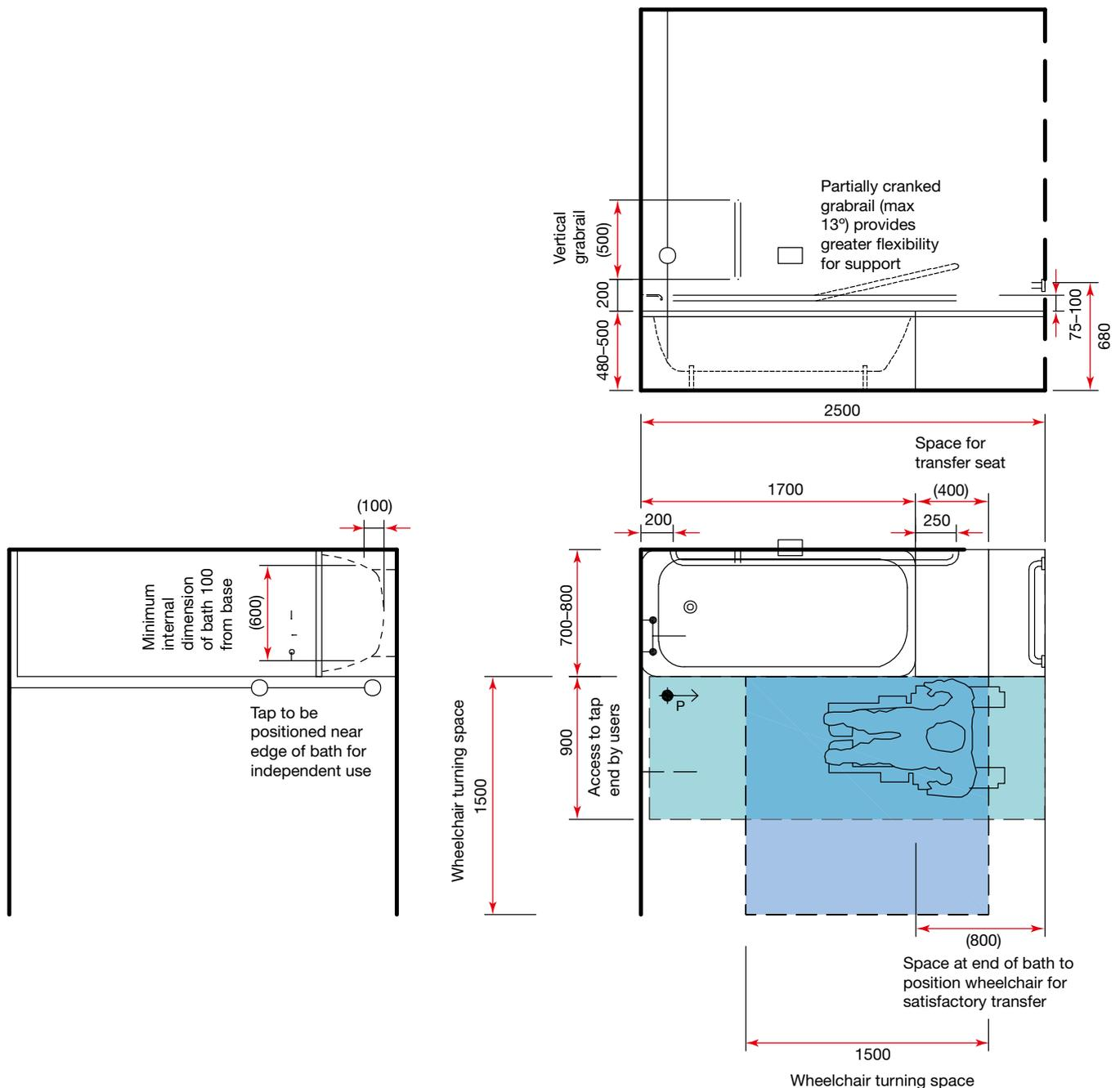

Figure 14 Space requirements for an independent wheelchair bath

*Toilet and adjacent hand-rinse basin:
independent wheelchair: grabrail options*

2.46 These ergonomic drawings (see Figure 15) show the fixing position of grabrails for an independent wheelchair toilet and adjacent hand-rinse basin.

2.47 Grabrails should be provided symmetrically on either side of the toilet at 320 mm from the centreline of the toilet pan. This conflicts with the recommendations in Approved Document M and BS 8300.

2.48 Approved Document M (paragraph 5.10j) states: “where the horizontal support rail on the wall adjacent to the toilet is set with the minimum spacing from the wall, an additional dropdown rail should be provided on the wall side at a distance of 320 mm from the centreline of the toilet.”

Note

Where the maximum spacing defined in Approved Document M, 85 mm, is used, this positions the grabrail approximately 390 mm from the centreline of the toilet, which is not symmetrical with the hinged grabrail on the other side.

2.49 BS 8300 (paragraph 12.6.3.5 b) states: “A fixed horizontal rail should be located on the side wall with a 50 mm to 60 mm clearance between the rail and the wall.” This places the rail approximately 420 mm from the centreline of the toilet, which is not symmetrical with the hinged grabrail on the other side.

2.50 The ergonomic drawings provided illustrate two options for the provision of grabrails. The room layouts on this website are based on option one.

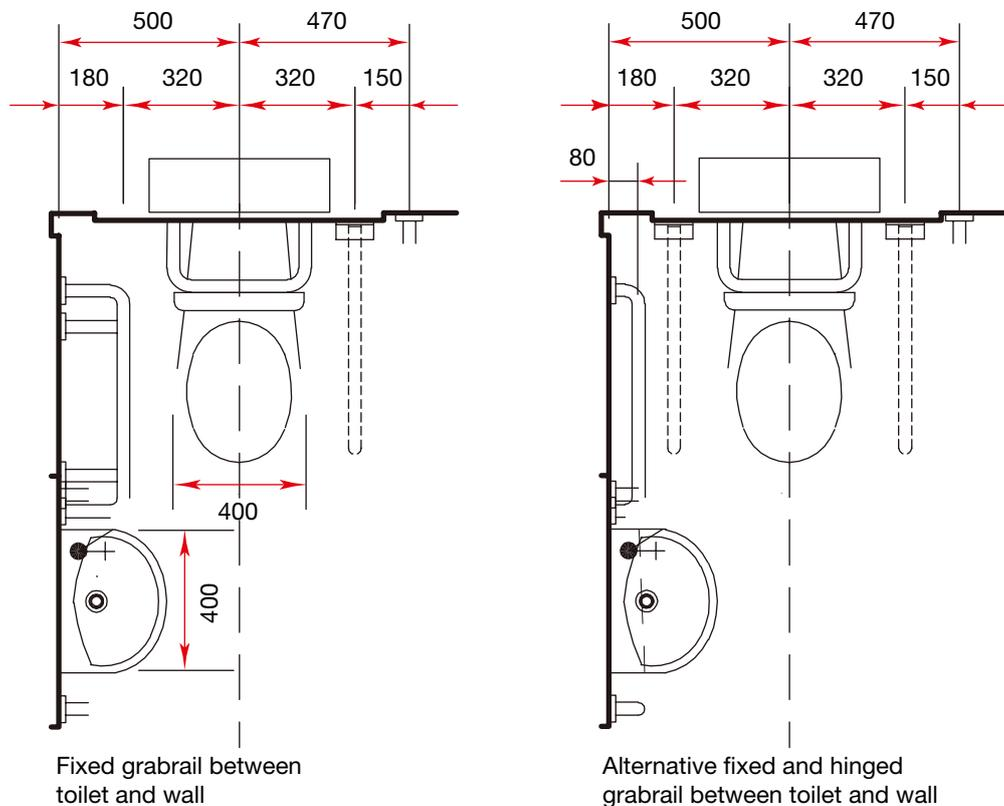

Figure 15 Space requirements showing the fixing position of grabrails for an independent wheelchair toilet and adjacent hand-rinse basin

Toilet and adjacent hand-rinse basin: independent wheelchair

2.51 This ergonomic drawing (see Figure 16) shows the space requirements for an independent wheelchair toilet and adjacent hand-rinse basin.

2.52 The recommended clear space in front and to the open side of the toilet (for independent wheelchair transfer) is greater than the recommendations in Approved Document M and BS 8300.

2.53 Approved Document M and BS 8300 recommend a minimum clear distance of 1000 mm to the open side of the centreline of the toilet for independent wheelchair transfer. Robert Feeney Associates (RFA) research for BS 8300 indicates that this will allow just over 60% of wheelchair users to comfortably transfer onto the toilet. The same research indicates that a clear space of 1400 mm accommodates 90% of wheelchair users and this is, therefore, recommended.

2.54 Approved Document M and BS 8300 recommend a 750 mm long toilet pan for independent wheelchair transfer. However, RFA research indicated that a 700 mm long toilet pan allows independent wheelchair transfer. For maximum space efficiency a 700 mm pan is recommended.

2.55 As a consequence of the reduction in pan length, the hand-rinse basin is located closer to the corner of the room than the position given in Approved Document M and BS 8300, to allow hand-rinsing from a seated position on the toilet.

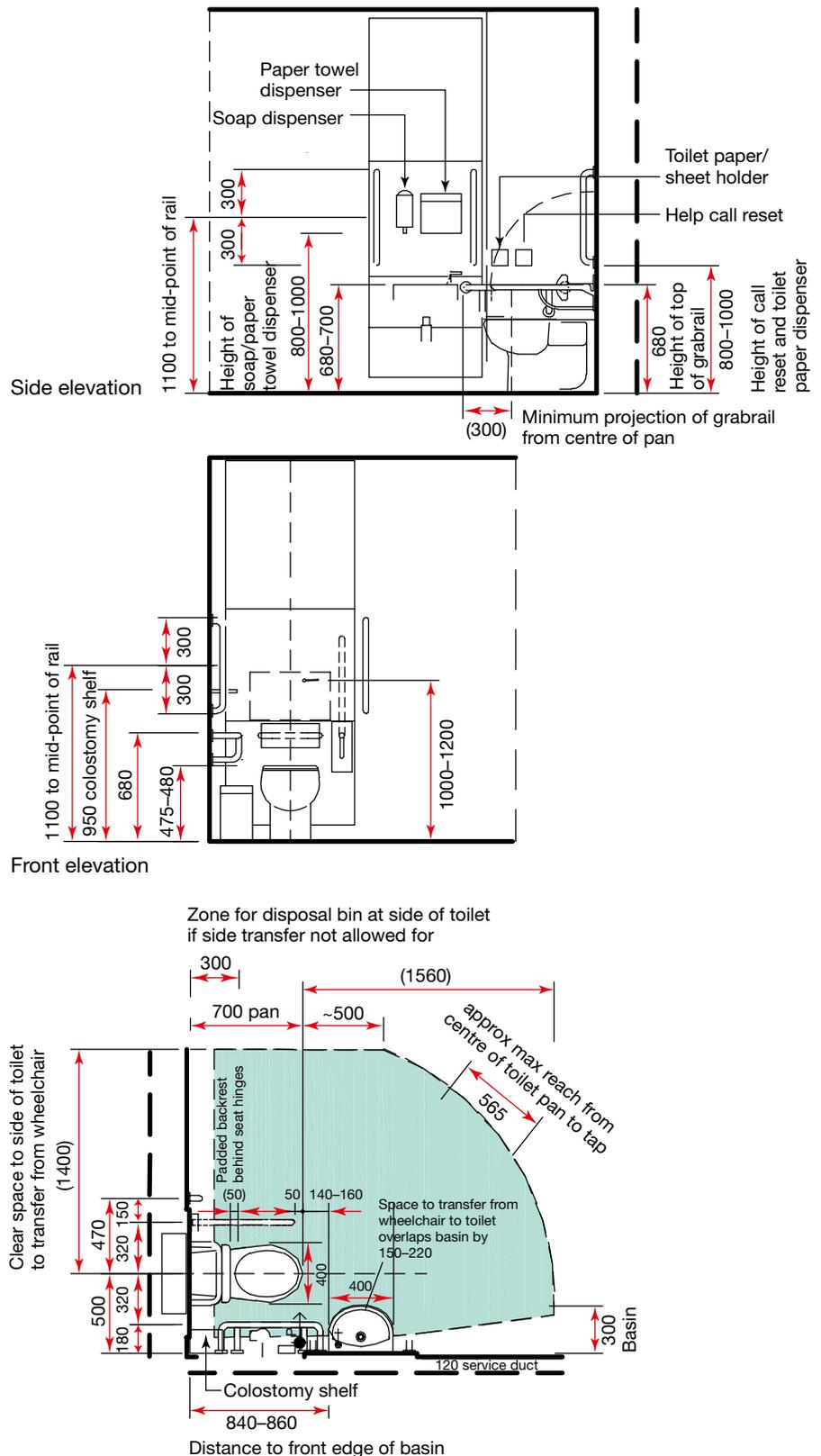

Figure 16 Space requirements for an independent wheelchair toilet and adjacent hand-rinse basin

Wash-hand basin: wheelchair

2.56 Wash-hand basins may be used for personal washing activities.

2.57 This ergonomic drawing (see Figure 17) shows the space requirements for a wheelchair accessible wash-hand basin. It is also suitable for seated use.

2.58 It includes a shaver socket adjacent to the wash-hand basin and a light above the mirror; these are optional. The inclusion of a shaver socket depends on project requirements. The need for a local light depends on the overall lighting scheme within the room.

2.59 The drawing also shows two short lever taps. Alternatively a single mixer tap

or sensor-operated taps may be used. See Health Building Note 00-10 Part C – ‘Sanitary assemblies’ for details.

2.60 Wheelchair-accessible wash-hand basins should have a size and profile that maximises access and reduces obstructions. They should:

- be as shallow as possible, that is, tapered from the rim to a depth not exceeding 250 mm at the outlet, which in turn should be positioned as near the supporting wall as possible;
- preferably project 500 mm in order to provide adequate leg room underneath the basin.

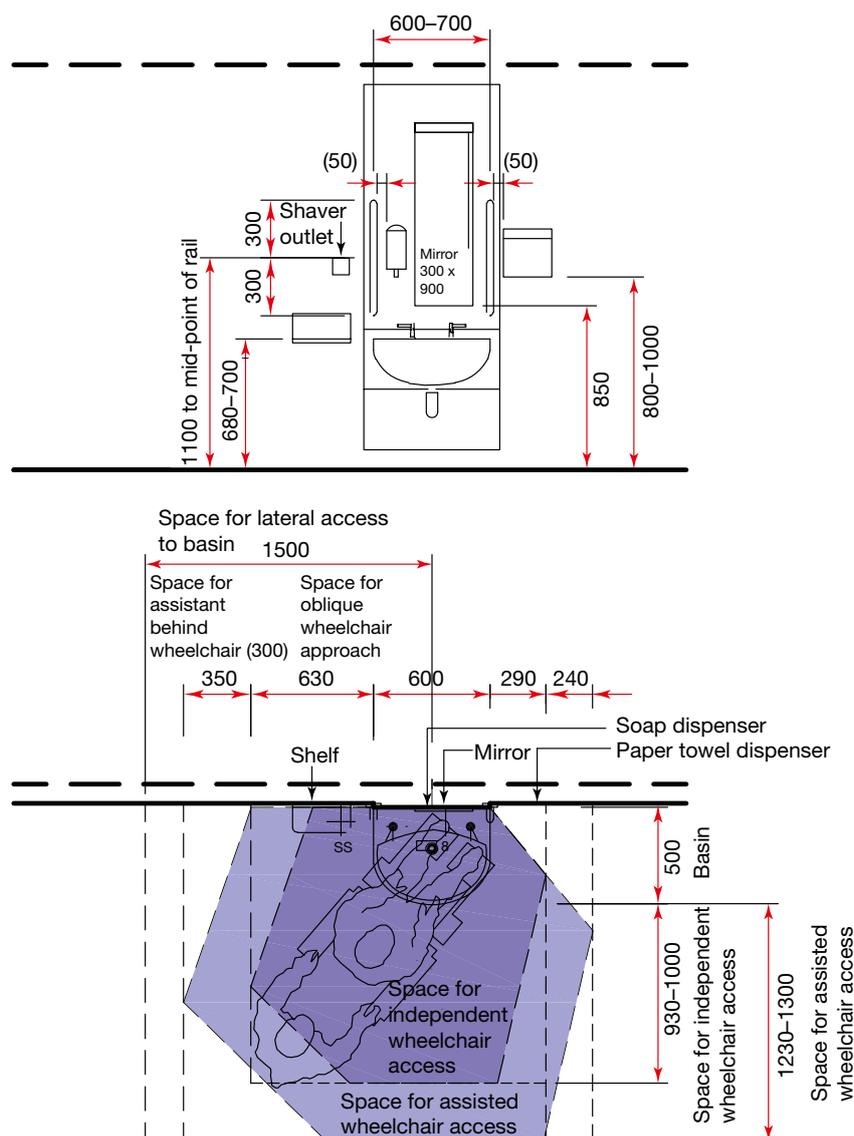

Figure 17 Space requirements for a wheelchair accessible wash-hand basin

Full-length mirror: standing or seated users

2.61 This ergonomic drawing (see Figure 18) shows the space requirements for a full-length mirror for standing or seated users.

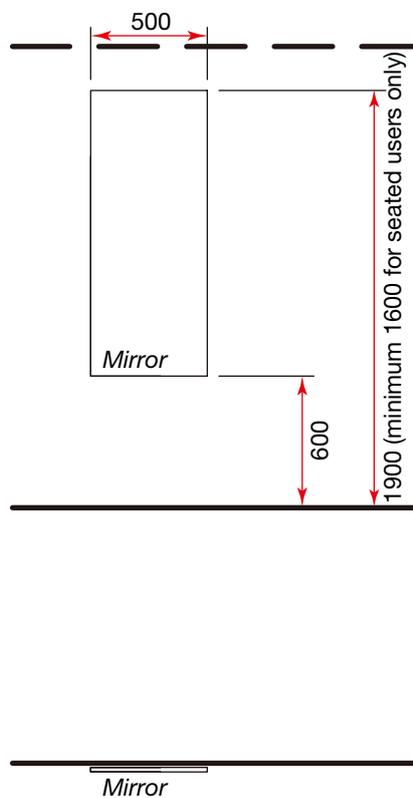

Figure 18 Space requirements for a full-length mirror for standing or seated users

Bathroom: semi-ambulant

Room description and layout

2.62 See Figure 19. The following activities take place in semi-ambulant bathrooms:

- undressing and dressing;
- hanging/holding clothes;
- use of the toilet;

- personal washing;
- use of the bath.

2.63 Semi-ambulant bathrooms should contain a semi-ambulant bath, semi-ambulant toilet and ambulant wash-hand basin.

2.64 Semi-ambulant bathrooms are also suitable for ambulant users.

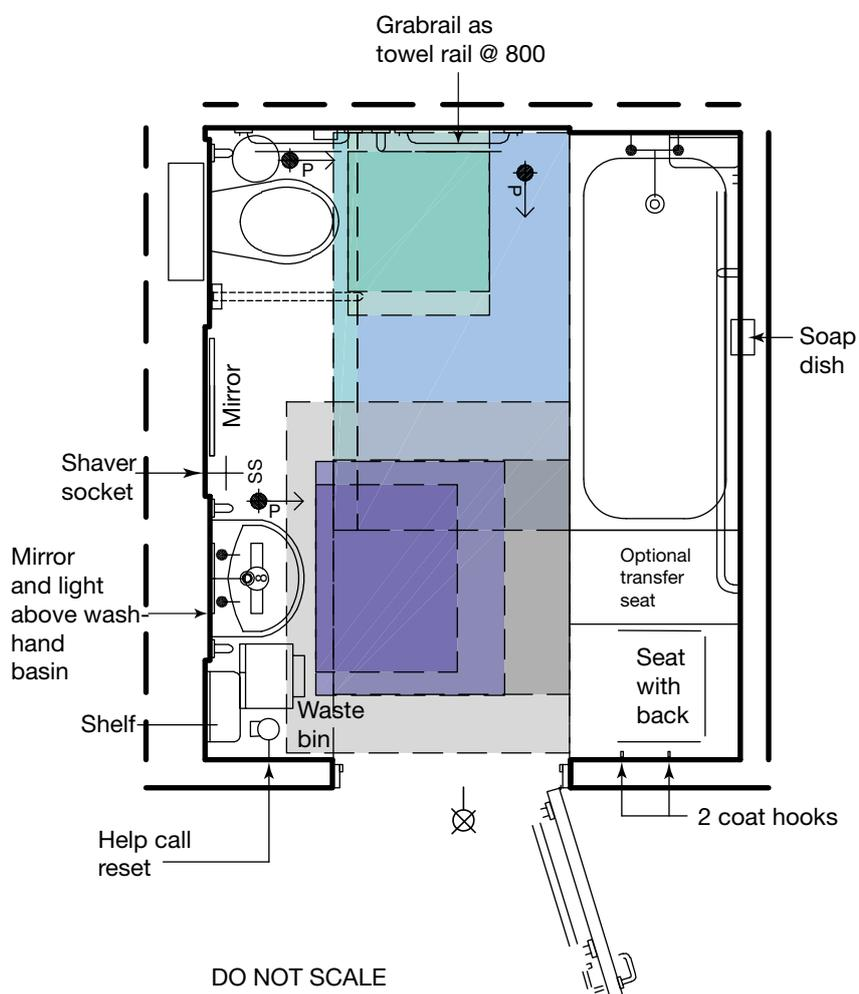

Figure 19 Space requirements for a bathroom: semi-ambulant

Ergonomic drawings

Dressing and undressing: ambulant

2.65 These ergonomic drawings (see Figure 20) show the space requirements for ambulant dressing and undressing.

2.66 An identical space provision is suitable for semi-ambulant users though it should be located adjacent to a seating area.

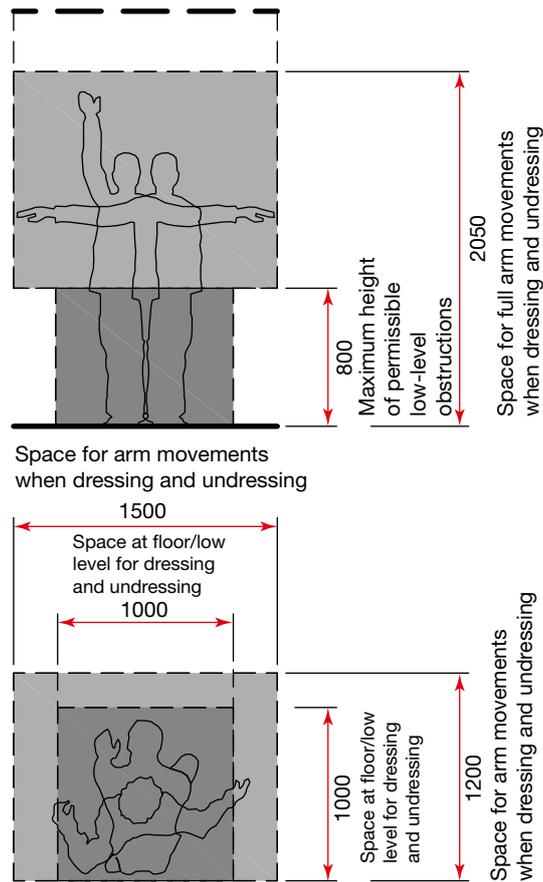

Figure 20 Space requirements for ambulant dressing and undressing

Toilet: semi-ambulant

2.67 This ergonomic drawing (see Figure 21) shows the space requirements for a semi-ambulant toilet.

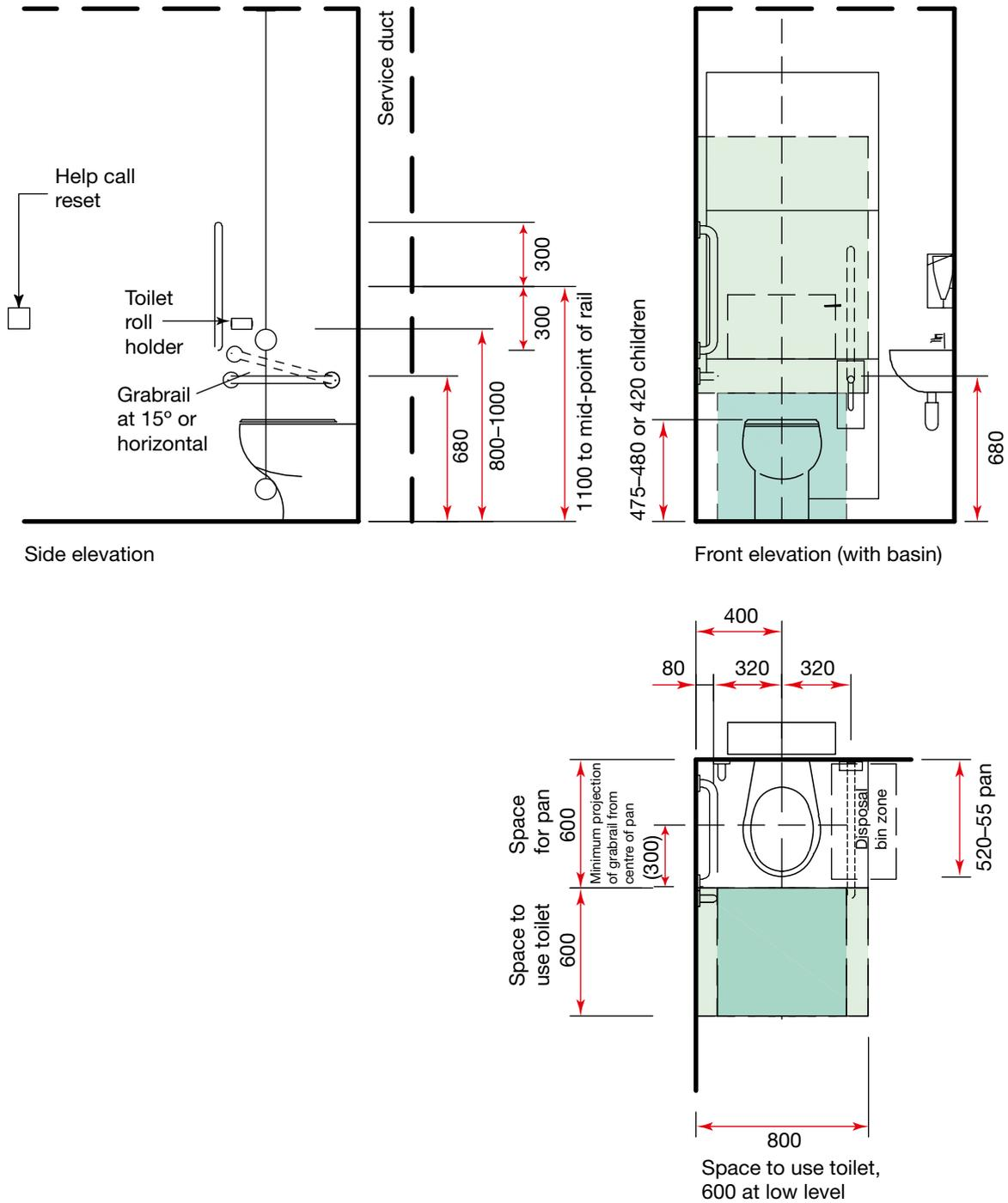

Figure 21 Space requirements for a semi-ambulant toilet

Wash-hand basin: ambulant

2.68 Wash-hand basins may be used for personal washing activities.

2.69 This ergonomic drawing (see Figure 22) shows the space requirements for ambulant/semi-ambulant use of a 400 mm deep x 500 mm wide wash-hand basin.

2.70 It includes a shaver socket adjacent to the wash-hand basin and a light above the mirror;

these are optional. The inclusion of a shaver socket depends on project requirements. The need for a local light depends on the overall lighting scheme within the room.

2.71 The drawing also shows two short lever taps. Alternatively a single mixer tap or sensor-operated taps may be used. See Health Building Note 00-10 Part C – ‘Sanitary assemblies’ for details.

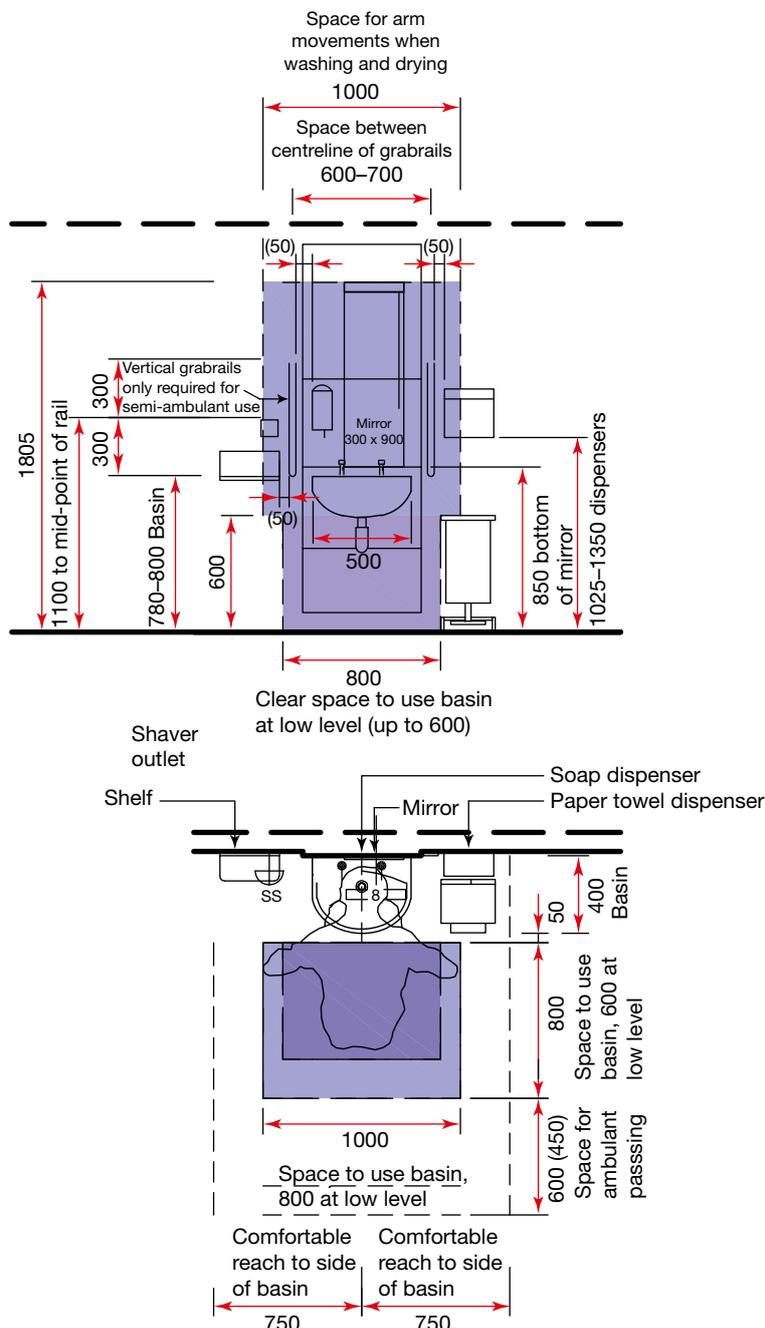

Figure 22 Space requirements for ambulant/semi-ambulant use of a 400 mm deep x 500 mm wide wash-hand basin

Full-length mirror: standing or seated users

2.72 This ergonomic drawing (see Figure 23) shows the space requirements for a full-length mirror for standing or seated users.

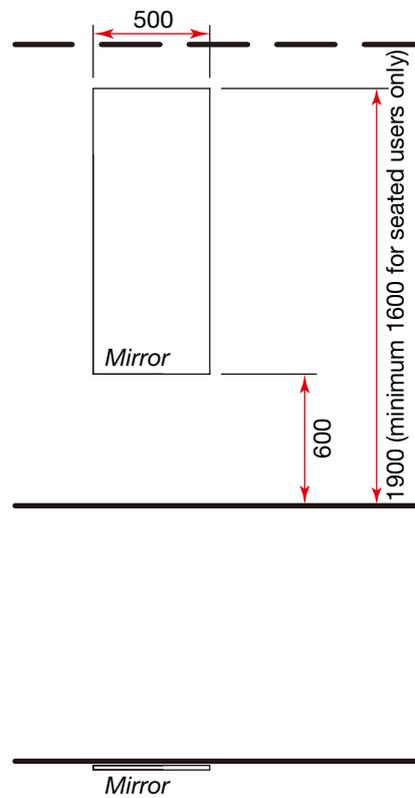

Figure 23 Space requirements for a full-length mirror for standing or seated users

Bath: semi-ambulant

2.73 This ergonomic drawing (see Figure 24) shows the space requirements for a semi-ambulant bath.

2.74 Where a fixed transfer seat is not provided at the foot of the bath, an independent use

bath hoist (chair) should be available, of the type that can be securely fixed to the bath rim when required. Manufacturers' advice should be sought regarding space requirements for such bath hoists.

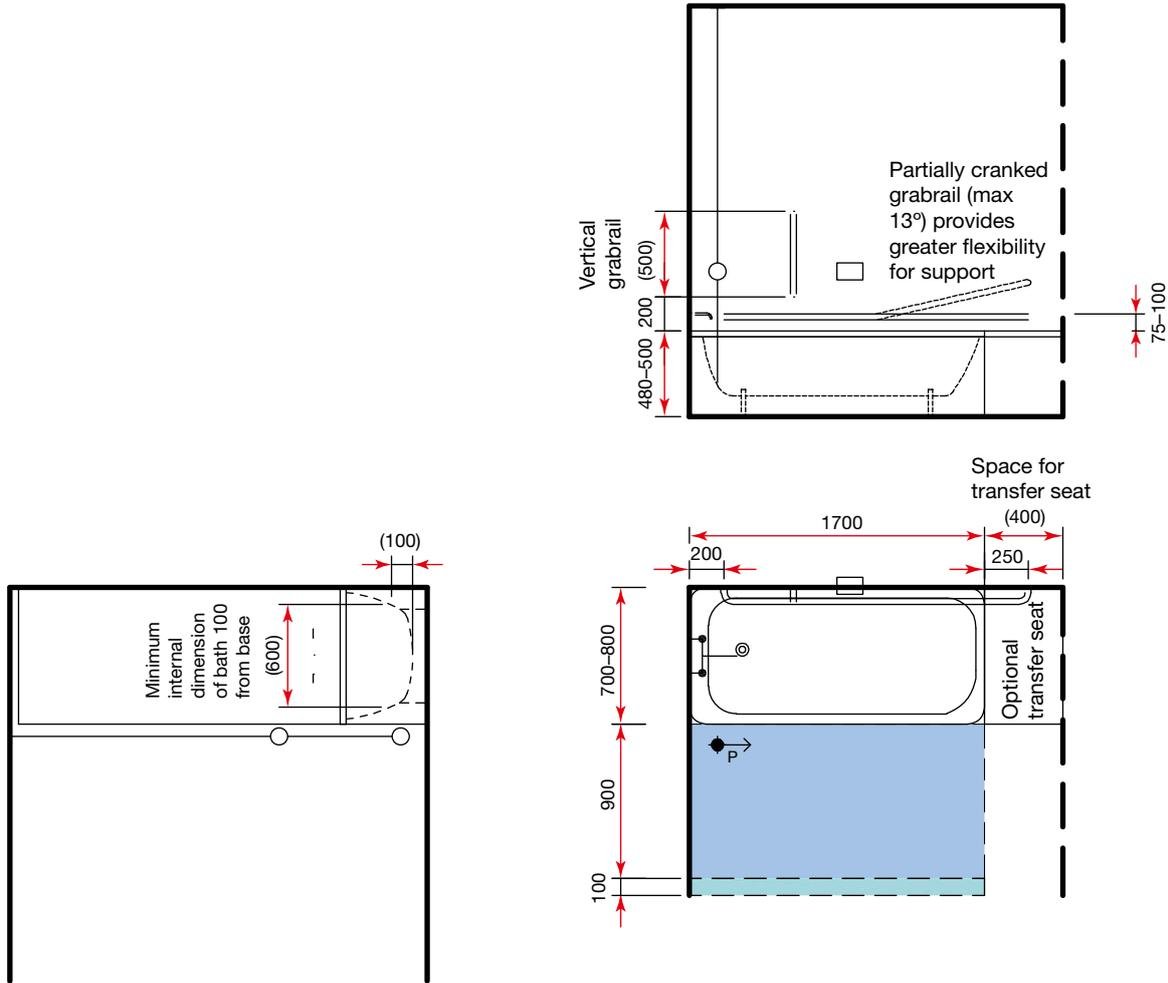

Figure 24 Space requirements for a semi-ambulant bath

3 Changing facilities

Changing area: staff

Room description and layout

3.1 The following activities take place in staff changing areas:

- undressing and dressing;
- changing into clean uniforms, blues or greens (including clean footwear);
- hanging/holding coats and wet clothes;
- storage of clothing and personal belongings;
- storage of clean footwear;
- depositing of dirty uniforms (optional).

3.2 Staff changing areas should include:

- full-length (lockable) lockers for clothing and personal belongings;
- open changing area and/or individual changing rooms;
- changing rails for secure storage of coats and wet clothes;
- storage space for clean footwear (required in theatres etc).

3.3 Separate changing facilities are required for male and female staff.

3.4 Access to the area should be controlled by a keypad lock, close proximity card or similar security system.

3.5 It is assumed that the following facilities will be provided separately but nearby:

- showers;
- wash-hand basins, with soap and paper

towel dispensers;

- toilets;
- shaving points (optional);
- power points for hairdryers;
- well-illuminated mirrors with shelves;
- uniform exchange area.

3.6 Consideration should be given to the provision of independent wheelchair showers and WCs in accordance with the requirements of Approved Document M.

3.7 As a minimum, the number of WCs and showers should be provided in accordance with the requirements of the Workplace (Health, Safety & Welfare) Regulations 1992, or current legislation.

3.8 Hand-rinse or personal washing facilities should be provided either within the associated WCs or immediately outside them, accessible from the changing area.

3.9 The room layout provided generally assumes ambulant or semi-ambulant use. Where independent wheelchair access is required, an independent wheelchair changing room(s) should be included and the minimum distance between lockers should be increased to 1500 mm. The area allocation, per locker, should therefore be increased accordingly.

3.10 Locker numbers should be provided on the following basis:

- for a shift system: twice the number of lockers as the maximum number of staff on duty at any one time (to allow for staff changeover), plus an allowance for visiting staff;

- for a non-shift system: the same number of lockers as the maximum number of staff on duty at any one time, plus an allowance for visiting staff.

3.11 The changing area provided should allow at least half the maximum number of staff on duty at any one time to change simultaneously. It is generally assumed that this will be in an open-plan space between lockers. At least one individual changing room should be provided.

3.12 The room layout (see Figure 25) includes 20 lockers and space for six people to change (suitable for a maximum of 10 staff on duty at any one time, including visiting staff).

3.13 The room layout includes the recommended minimum of one semi-ambulant changing room. Consideration should be given to:

- the number of individual changing rooms required. This will depend on local policy;
- the provision of independent wheelchair changing rooms in accordance with the requirements of Approved Document M.

3.14 The actual space requirements for lockers and changing will depend upon the size and quantity of lockers and whether changing space is provided in open-plan space between the lockers or in individual changing rooms. However, as a general guide the following space allocations should be allowed:

- Where changing space is generally provided in the open space between lockers, 1.1 m² per full-height locker for up to 30 lockers and 0.75 m² per full-height locker for greater than 30 lockers;

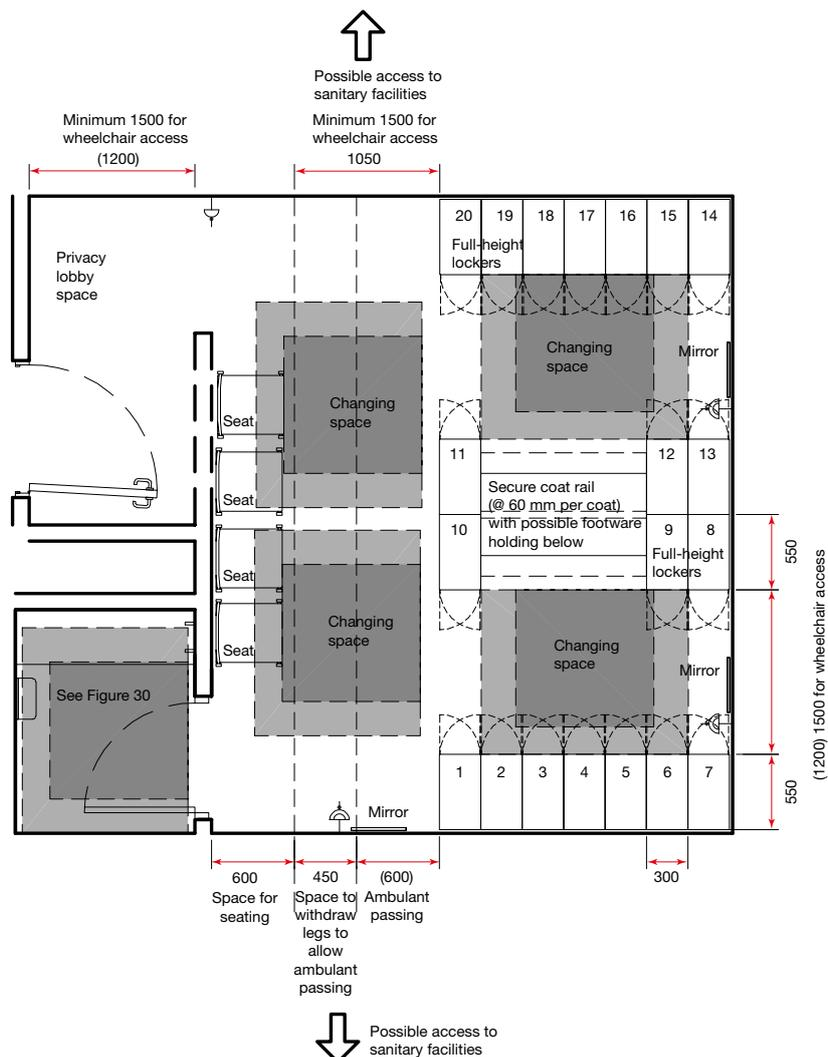

Figure 25 Space requirements for changing area: staff, 20 lockers

- b. Where changing space is provided within separate changing cubicles, 0.75 m² per full-height locker for up to 50 lockers.

3.15 For the purposes of creating a briefing schedule, staff changing areas may be sized at 1.4 m² per locker. This allows for full height lockers, communal changing space for approx 25% of the lockers, an allowance for local uniform exchange, one individual semi-ambulant changing room and one ambulant shower room for every 20 lockers. It assumes cube lockers for personal belongings, if provided, are located elsewhere. See the table below.

3.16 The allowance does not include WCs, which need to be calculated separately based on the total number of staff.

3.17 When dividing changing areas into separate male and female allowance each space should be overprovided by, say, 10% to allow for flexibility in the percentage split between male and female users.

3.18 The staff multiplier for uniform exchange assumes that not everybody works full-time. In critical care areas, the multiplier may be as big as 5 but generally:

- 3.5 is considered reasonable for a facility with a shift system;
- 1.2 is considered acceptable for a facility without a shift system.

Table 1 Changing areas: staff

Shift system 40 lockers = 20 staff on duty						
	Staff multiplier for uniform exchange	Qty	Area (m ²)	Total		
Changing area: 20 lockers		2	20	40		
Semi-ambulant changing room		2	2	4		
Ambulant shower room		2	2	4		
Uniform exchange lockers	5	100	0.1	10		
				58	or	1.45 sq m per locker
Shift system 40 lockers = 20 staff on duty						
	Staff multiplier for uniform exchange	Qty	Area (m ²)	Total		
Changing area: 20 lockers		2	20	40		
Semi-ambulant changing room		2	2	4		
Ambulant shower room		2	2	4		
Uniform exchange lockers: 70	3.5	70	0.1	7		
				55	or	1.38 sq m per locker
Non-shift system 40 lockers = 40 staff on duty						
	Staff multiplier for uniform exchange	Qty	Area (m ²)	Total		
Changing area: 20 lockers		2	20	40		
Semi-ambulant changing room		2	2	4		
Ambulant shower room		2	2	4		
Uniform exchange lockers: 80	1.2	48	0.1	4.8		
				52.8	or	1.32 sq m per locker
				AVERAGE		1.4 sq m per locker

Ergonomic drawings

Dressing and undressing: ambulant

3.19 These ergonomic drawings (see Figure 26) show the space requirements for ambulant dressing and undressing.

3.20 An identical space provision is suitable for semi-ambulant users though it should be located adjacent to a seating area.

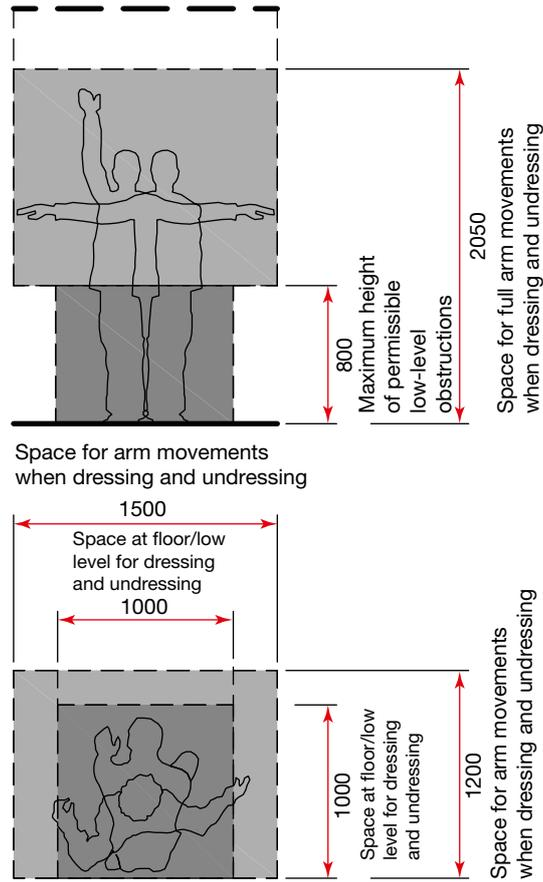

Figure 26 Space requirements for ambulant dressing and undressing

Full-length mirror: standing or seated users

3.21 This ergonomic drawing (see Figure 27) shows the space requirements for a full-length mirror for standing or seated users.

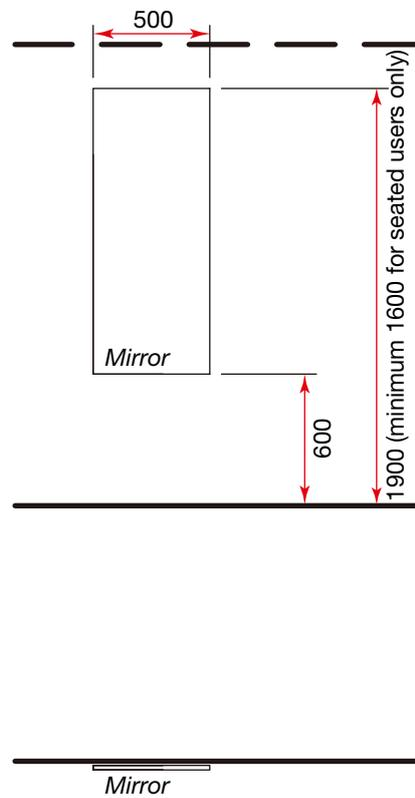

Figure 27 Space requirements for a full-length mirror for standing or seated users

Changing room: independent wheelchair

Room description and layout

3.22 See Figures 28 and 29. The following activities take place in independent wheelchair changing rooms:

- undressing and dressing;
- hanging/holding clothes;

- wheelchair transfer to the bench or tip-up seat.

3.23 Independent wheelchair changing rooms should contain a full-length mirror, a shelf for holding personal belongings, a bench or tip-up seat and two coat hooks for hanging garments.

3.24 Help call should be provided if the room is for staff or patient use.

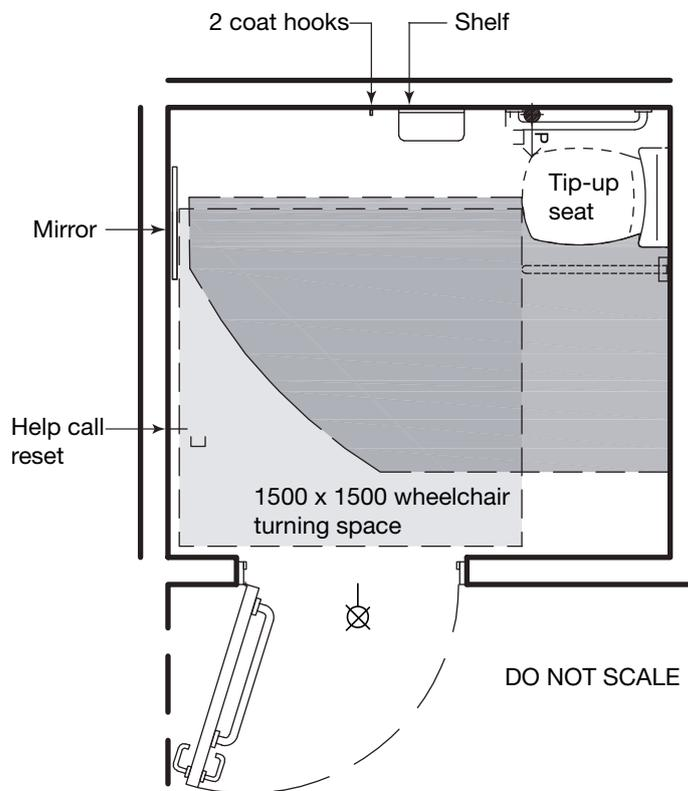

Figure 28 Space requirements for independent wheelchair changing room

Ergonomic drawings

Independent wheelchair changing

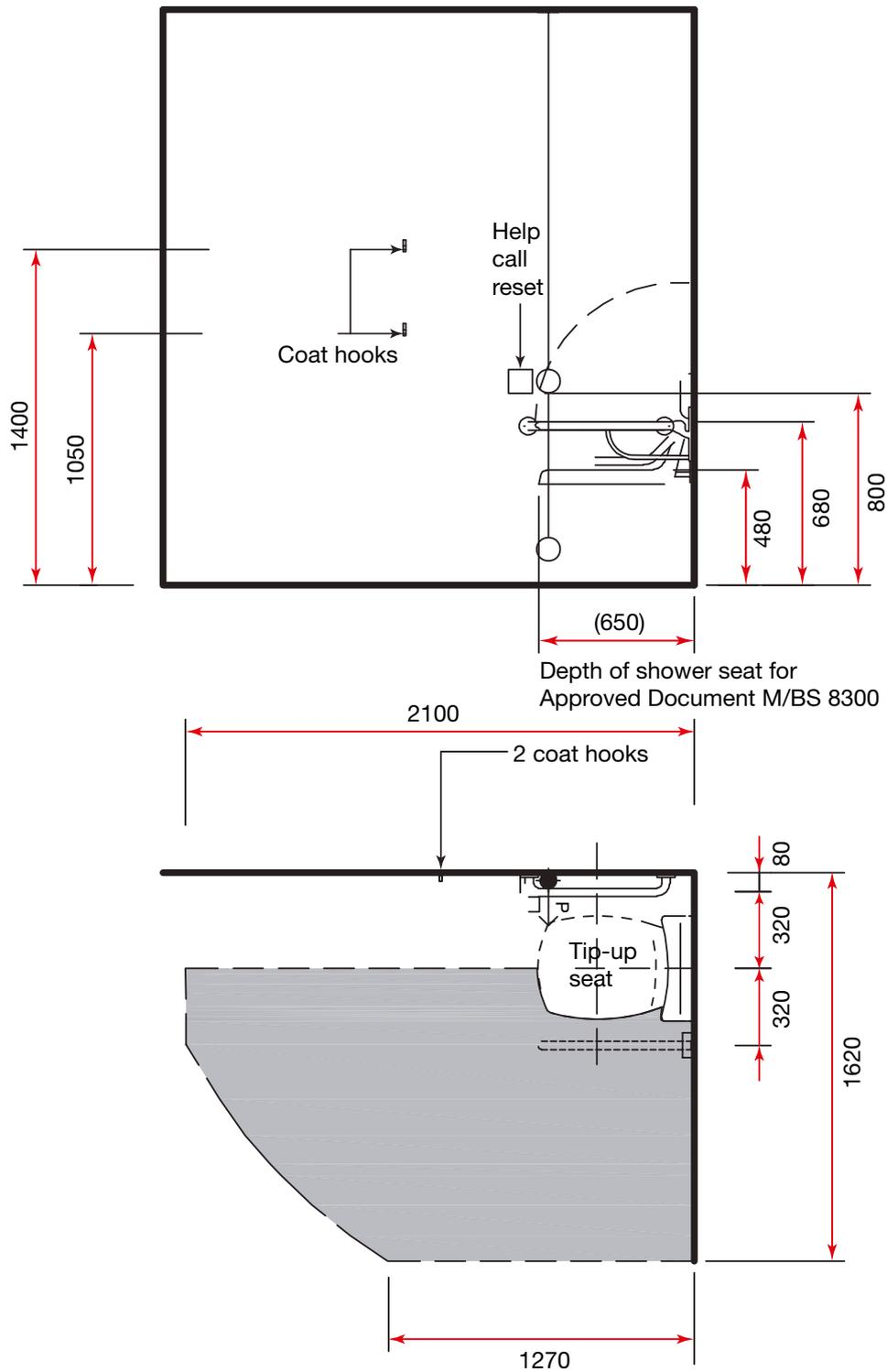

Figure 29 Independent wheelchair changing room

Changing room: semi-ambulant

Room description and layout

3.25 See Figure 30. The following activities take place in semi-ambulant changing rooms:

- undressing and dressing;
- hanging/holding clothes.

3.26 Semi-ambulant changing rooms should contain a full-length mirror, a shelf for holding personal belongings, a bench or tip-up seat and two coat hooks for hanging garments.

3.27 They are also suitable for ambulant use.

3.28 Help call should be provided if the room is for patient use.

3.29 The room should be lockable. Clothes/belongings may either be locked in the room or in a separate locker, or kept with the patient.

3.30 Access arrangements to and from the room and its relationship with changed waiting areas (where provided) should ensure patient privacy and dignity.

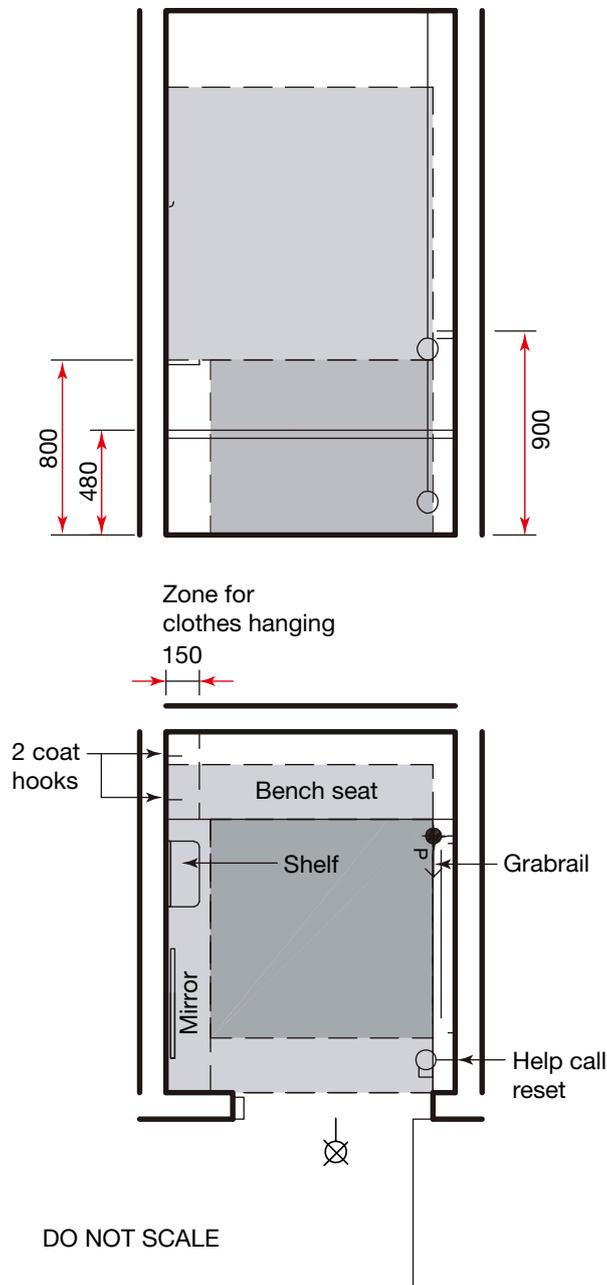

Figure 30 Space requirements for changing room: semi-ambulant

Ergonomic drawings

Dressing and undressing: ambulant

3.31 These ergonomic drawings (see Figure 31) show the space requirements for ambulant dressing and undressing.

3.32 An identical space provision is suitable for semi-ambulant users though it should be located adjacent to a seating area.

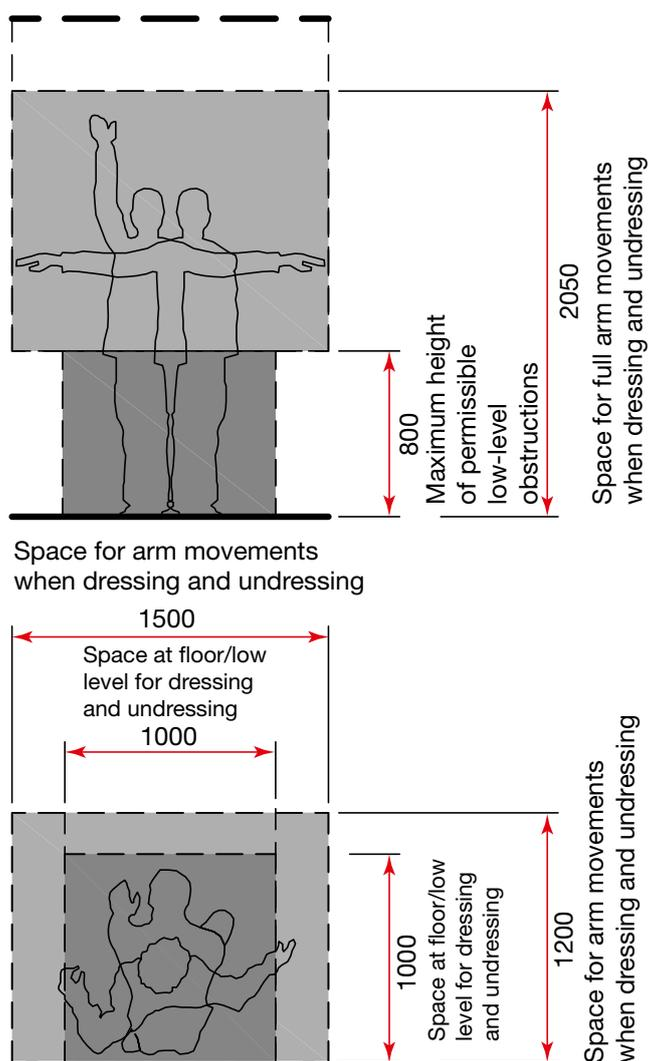

Figure 31 Space requirements for ambulant dressing and undressing

Full-length mirror: standing or seated users

3.33 This ergonomic drawing (see Figure 32) shows the space requirements for a full-length mirror for standing or seated users.

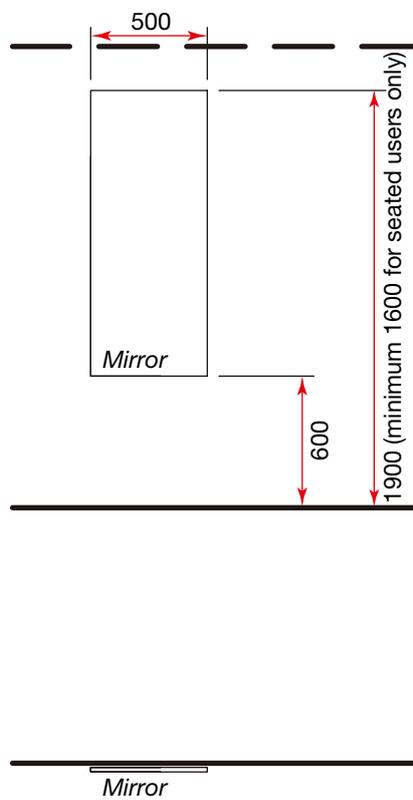

Figure 32 Space requirements for a full-length mirror for standing or seated users

Nappy changing room

Room description and layout

3.34 The following activities take place in nappy changing rooms:

- changing infants' nappies;
- disposal of soiled nappies;
- personal washing.

3.35 Nappy changing rooms are suitable for use by a single ambulant adult with a baby or infant.

3.36 Nappy changing rooms should contain the following:

- changing table;
- shelf, at worktop height, at the end of the table for placing packs of wipes etc (not above the table, as the parent/carer may hit their head when rising);
- seat for a parent/carer;
- wash-hand basin with sensor-operated taps;
- disposal bin for soiled nappies and other clinical waste;

- soap dispenser and paper towel dispenser;
- waste bin for used paper towels.

3.37 Sensor-operated taps are recommended for infection control; users may have heavily soiled hands and, as this is a public space, the room may not be fully cleaned between usages.

3.38 The folding nappy changing table recommended in Approved Document M (paragraph 5.14d) for use in larger semi-ambulant WCs is not recommended in healthcare premises. In healthcare premises, it is recommended that nappy changing facilities should be provided separately from WC provision.

3.39 The room layout provided (see [Figure 33](#)) illustrates two options for the changing table within the same overall space: a fold-down table with primary access from the end and a fixed or adjustable-height changing table with access from one end.

3.40 Sound attenuation of doors, ceilings and partitions should be considered to prevent the sound of crying children travelling into adjacent spaces.

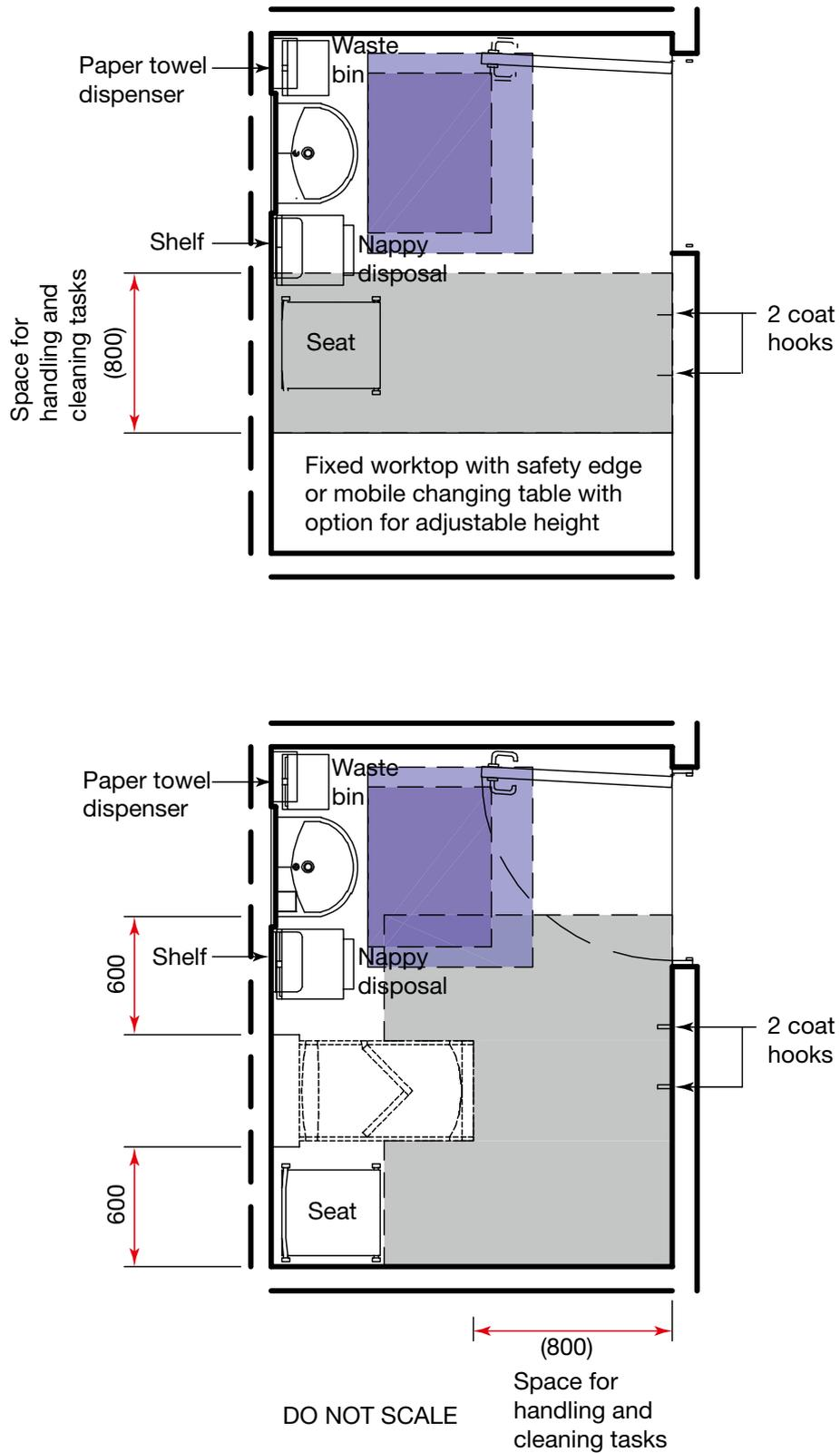

Figure 33 Space requirements for nappy changing room

Ergonomic drawings

Wash-hand basin: ambulant

3.41 Wash-hand basins may be used for personal washing activities.

3.42 This ergonomic drawing (see Figure 34) shows the space requirements for ambulant/semi-ambulant use of a 400 mm deep x 500 mm wide wash-hand basin.

3.43 It includes a shaver socket adjacent to the wash-hand basin and a light above

the mirror; these are optional. The inclusion of a shaver socket depends on project requirements. The need for a local light depends on the overall lighting scheme within the room.

3.44 The drawing also shows two short lever taps. Alternatively a single mixer tap or sensor-operated taps may be used. See Health Building Note 00-10 Part C – ‘Sanitary assemblies’ for details.

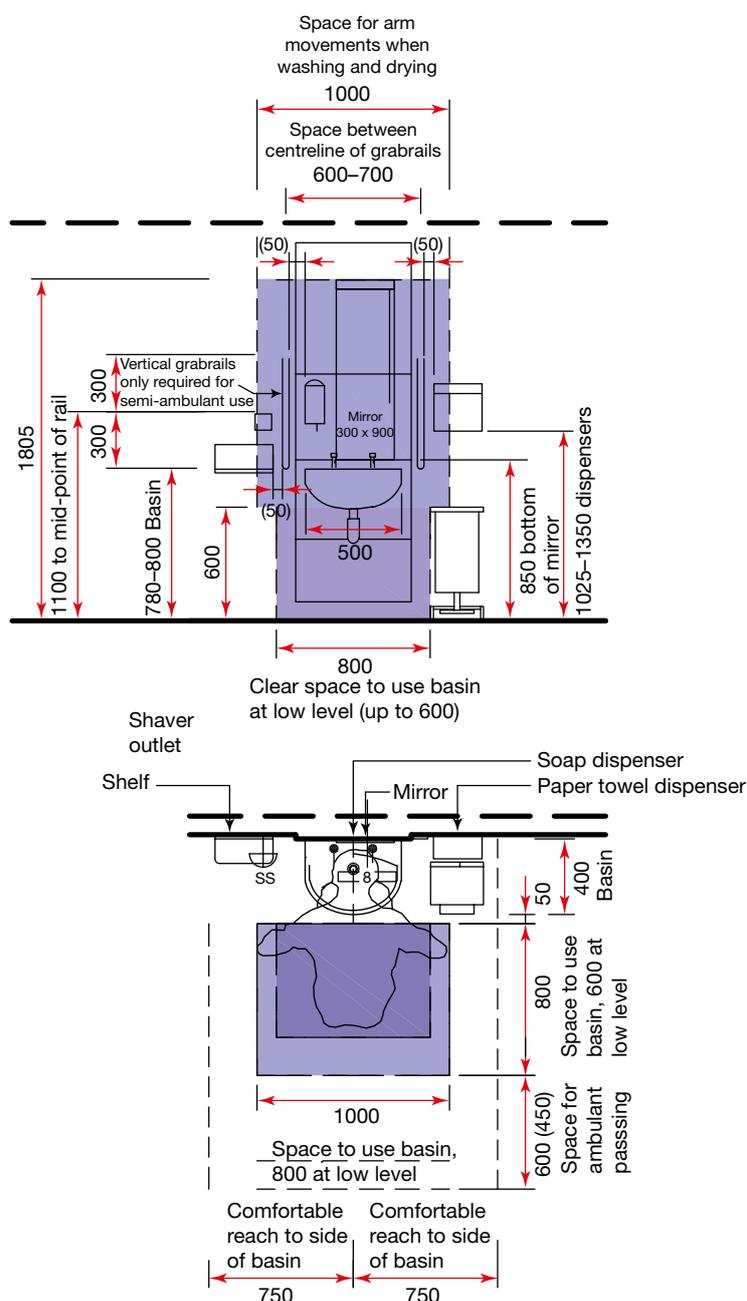

Figure 34 Space requirements for ambulant/semi-ambulant use of a 400 mm deep x 500 mm wide wash-hand basin

Uniform exchange area

Room description and layout

3.45 It is assumed that separate lockers will be provided for uniform exchange (for personalised uniforms only). Non-personalised uniforms may be provided in the changing areas or adjacent lobby.

3.46 The layout provided (see Figure 35) shows 70 lockers, 10 high in each bank, with a built-in dirty uniform collection point.

3.47 The actual number of uniform exchange lockers required will depend upon the number of staff working in any given area. An allowance of 0.1 m² per uniform locker has been allowed.

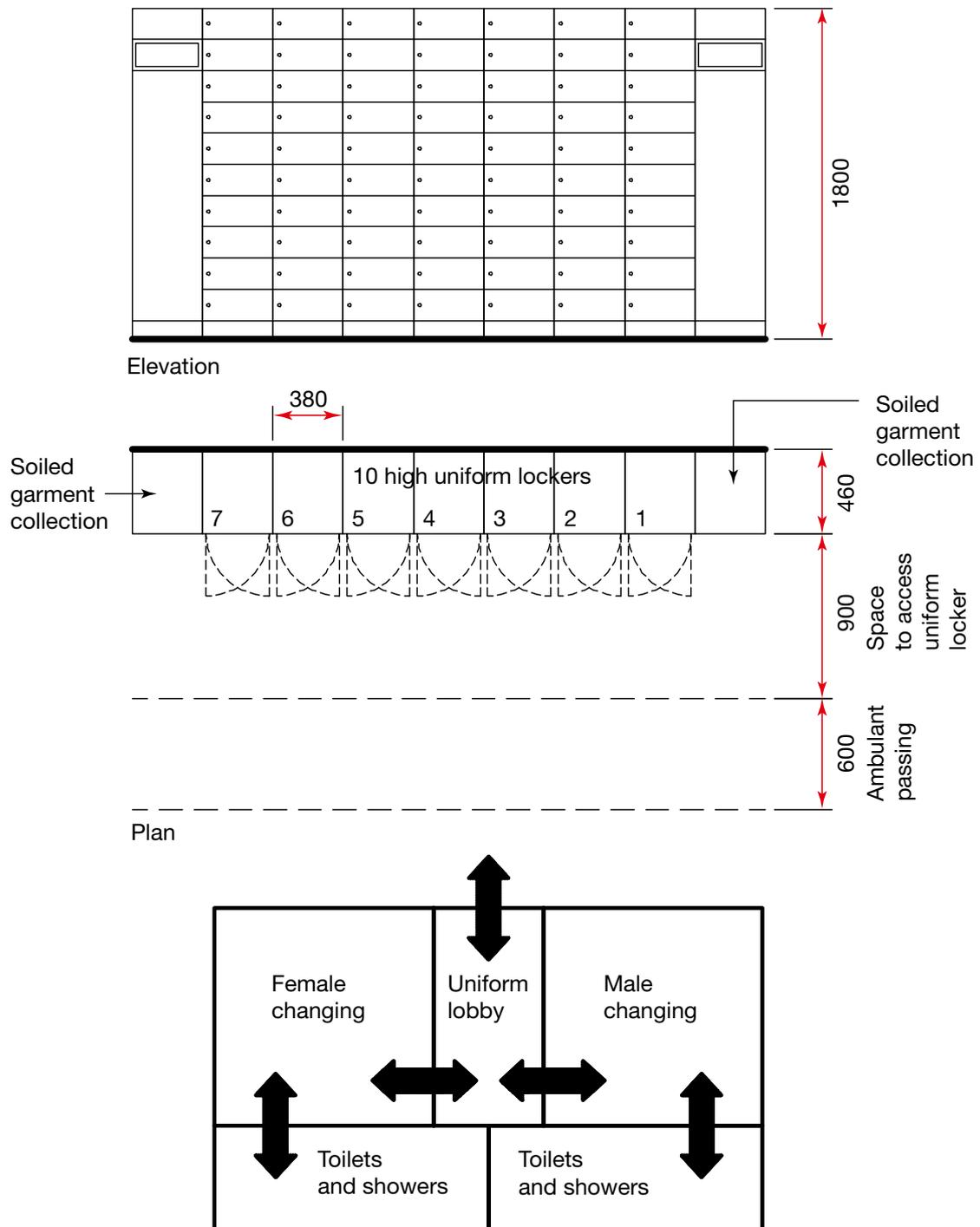

Figure 35 Space requirements for 70 lockers, 10 high in each bank, built-in dirty uniform collection point

4 Shower rooms

Shower room: ambulant

Room description and layout

4.1 See Figure 36. The following activities take place in ambulant shower rooms:

- undressing and dressing;
- hanging/holding clothes;
- showering.

4.2 Ambulant shower rooms (without toilets or tip-up shower seats) are only suitable for fully ambulant staff or visitors.

4.3 The use of shower trays is acceptable in ambulant shower rooms. They should not be used in any patient areas as they present a tripping hazard.

4.4 An inward-opening door may be used without increasing the space requirements within the room.

4.5 The room layout provided shows a small mirror. Alternatively, a full-length mirror may be provided.

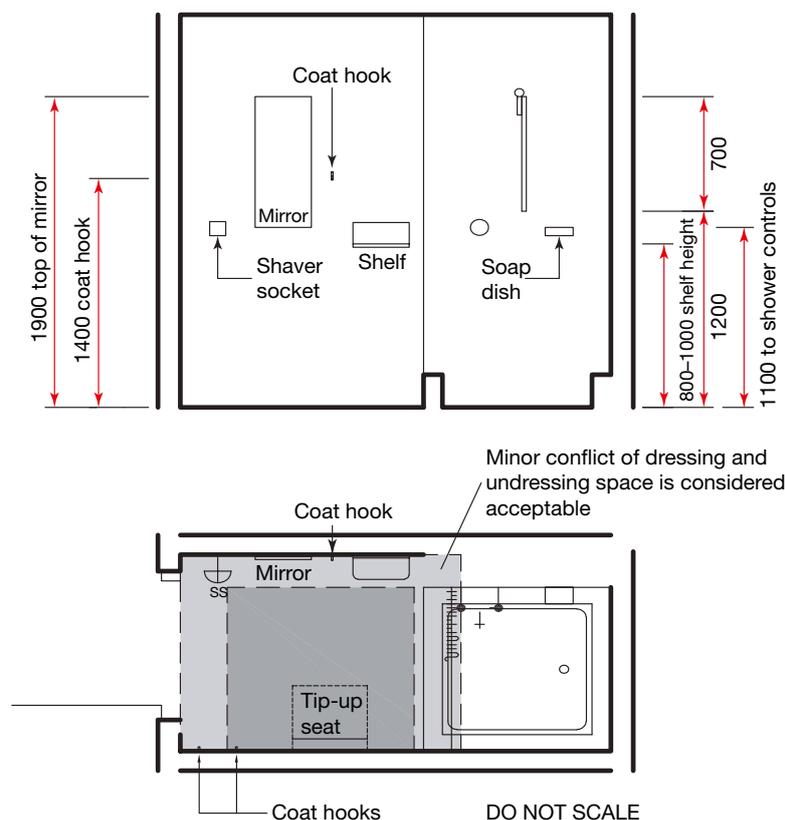

Figure 36 Space requirements for ambulant shower room

Ergonomic drawings

Dressing and undressing: ambulant

4.6 These ergonomic drawings (see Figure 37) show the space requirements for ambulant dressing and undressing.

4.7 An identical space provision is suitable for semi-ambulant users though it should be located adjacent to a seating area.

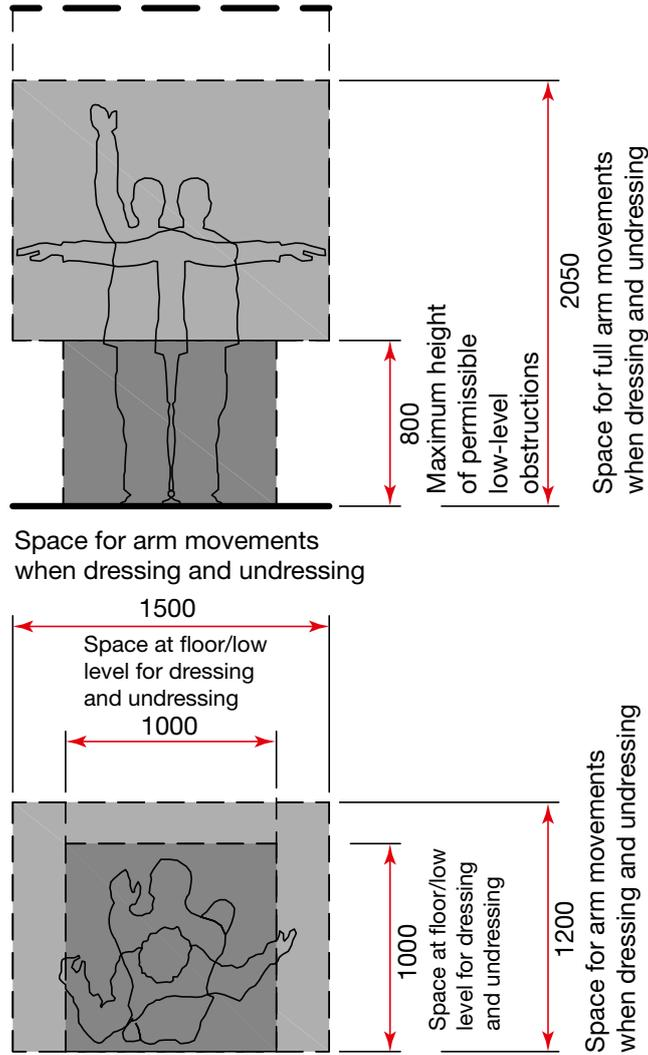

Figure 37 Space requirements for ambulant dressing and undressing

Shower room: assisted

Room description and layout

4.8 The following assisted activities take place in assisted shower rooms:

- undressing and dressing;
- hanging/holding clothes;
- wheelchair, sanitary chair and shower chair access to the toilet, wash-hand basin and shower;
- mobile hoist access to transfer a patient to the toilet or shower seat or to attend to a patient collapsed on the floor;
- patient transfer from a wheelchair to the toilet or shower seat (supervised only);
- use of the toilet;
- personal washing (whilst seated);
- showering (whilst seated).

4.9 An assisted shower room should contain an assisted shower with tip-up shower seat, assisted toilet and wheelchair wash-hand basin.

4.10 The assisted shower should provide staff access from both sides and from the front of the shower and to the shower controls.

4.11 Staff should be able to remain dry whilst assisting in showering.

4.12 Mobile hoist access will be required if a patient collapses on the floor, even if it is not used for transferring patients to the toilet.

4.13 The room layout provided (see [Figure 38](#)) includes a fixed tip-up shower seat. A mobile shower chair may be used instead of the tip-up shower seat.

4.14 Assisted wheelchair and hoist transfer to the shower seat is only possible from the right-hand side of the shower (if facing the shower). Consideration should be given to providing both left- and right-hand versions of this layout to allow for all users.

4.15 Where assisted shower rooms are provided en-suite to bedrooms and additional assisted shower rooms or bathrooms are provided nearby, consideration may be given to reducing the clear space in front and to the side of the toilet in accordance with the en-suite shower room layouts.

4.16 To enable this space to be suitable for ambulant and semi-ambulant use as well as assisted use, an adjustable-height wash-hand basin may be provided in place of the wheelchair wash-hand basin.

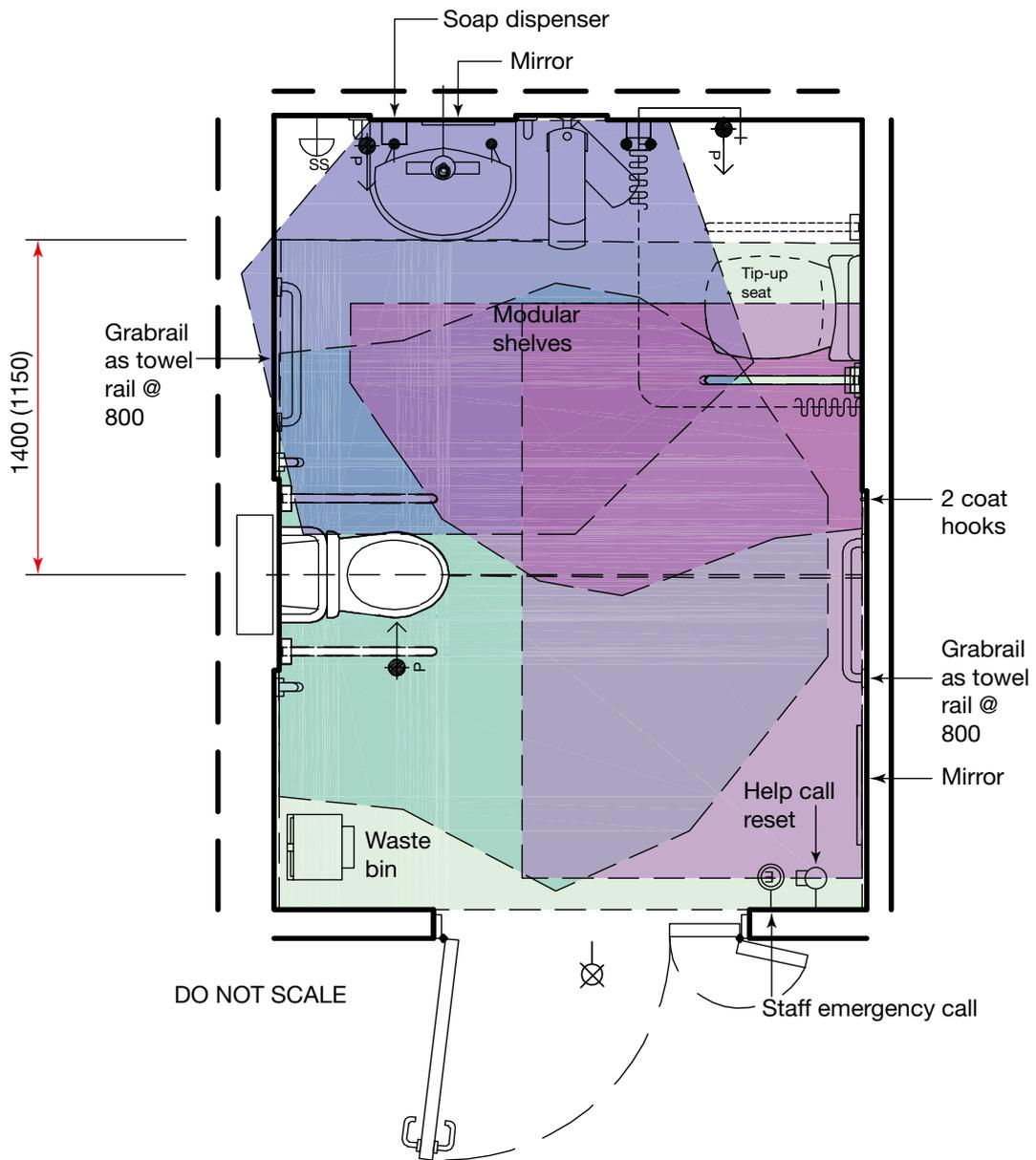

Figure 38 Space requirements for shower room: assisted

Ergonomic drawings

Assisted shower with fixed tip-up shower seat

4.17 This ergonomic drawing (see Figure 39) shows the space requirements for an assisted shower with a fixed tip-up shower seat.

4.18 Fixed-position shower controls should be sited close to the shower curtain and at a height of 900–1000 mm to satisfy both staff and seated users.

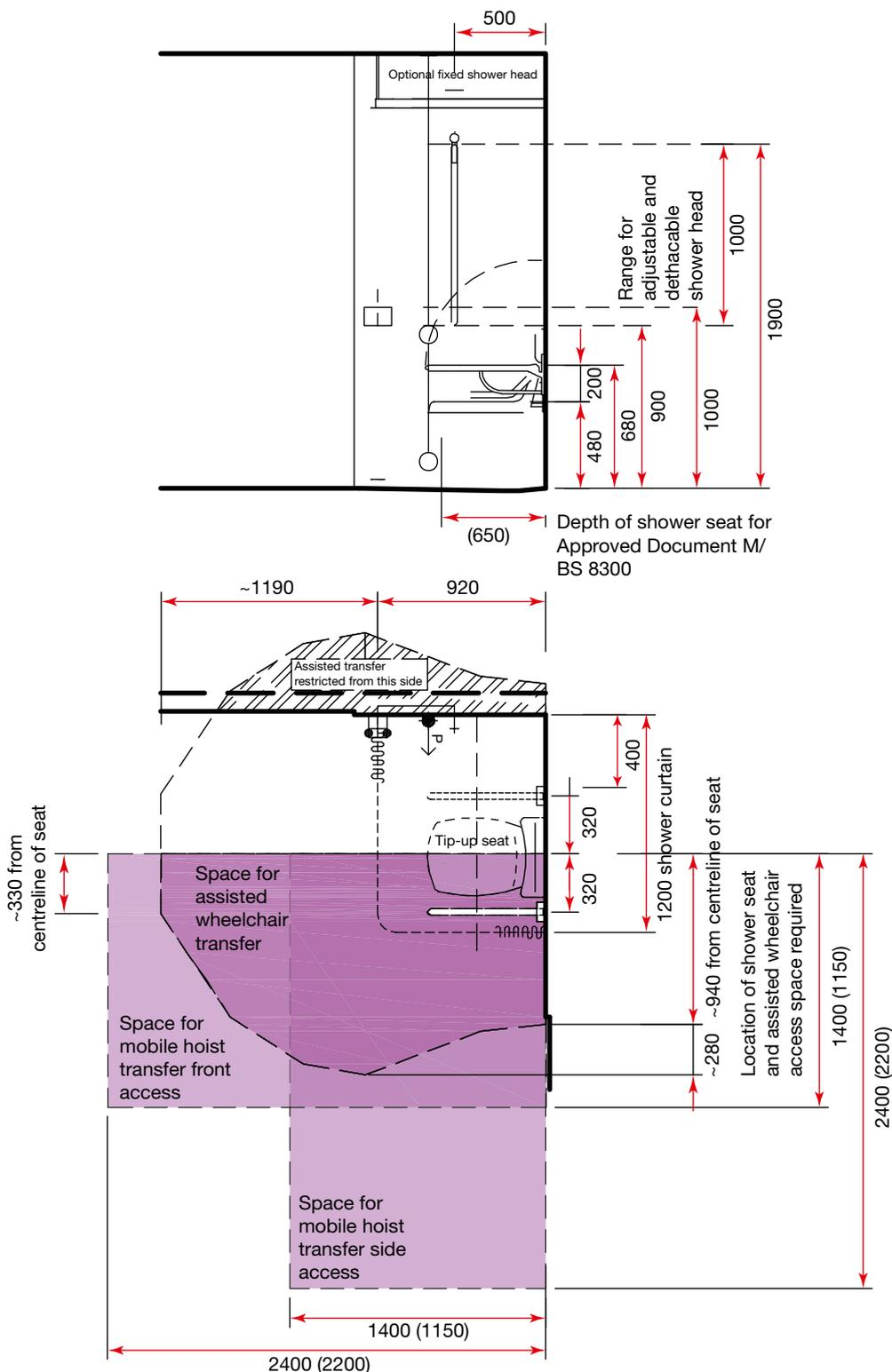

Figure 39 Space requirements for assisted shower with fixed tip-up shower seat

Toilet: assisted

4.19 This ergonomic drawing (see Figure 40) shows the space requirements for an assisted toilet.

4.20 The clear space on either side of the toilet for mobile hoist transfer is greater than that recommended in BS 8300 (Figure 55).

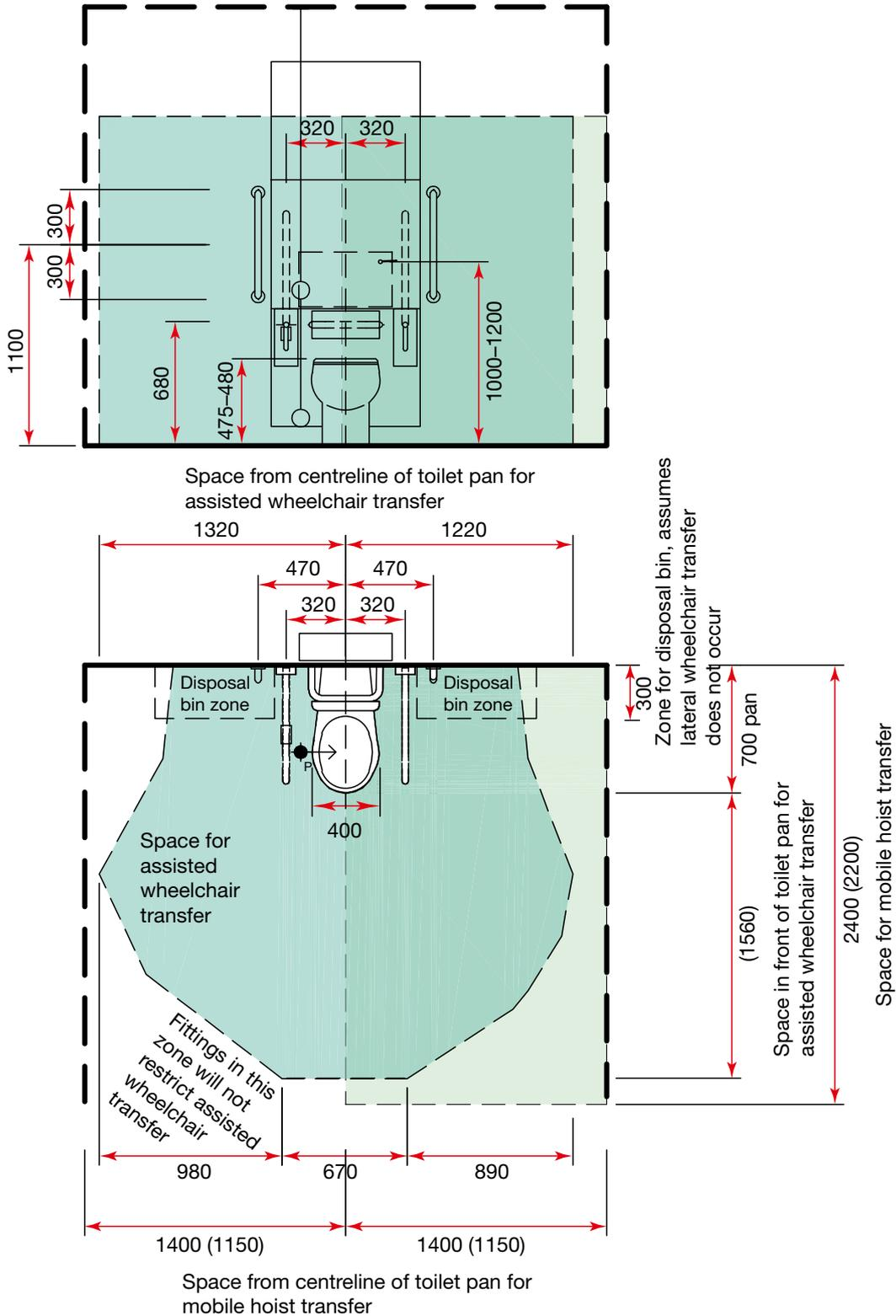

Figure 40 Space requirements for assisted toilet

Wash-hand basin: wheelchair

4.21 Wash-hand basins may be used for personal washing activities.

4.22 This ergonomic drawing (see Figure 41) shows the space requirements for a wheelchair accessible wash-hand basin. It is also suitable for seated use.

4.23 It includes a shaver socket adjacent to the wash-hand basin and a light above the mirror; these are optional. The inclusion of a shaver socket depends on project requirements. The need for a local light depends on the overall lighting scheme within the room.

4.24 The drawing also shows two short lever taps. Alternatively a single mixer tap or sensor-operated taps may be used. See Health Building Note 00-10 Part C – ‘Sanitary assemblies’ for details.

4.25 Wheelchair-accessible wash-hand basins should have a size and profile that maximises access and reduces obstructions. They should:

- be as shallow as possible, that is, tapered from the rim to a depth not exceeding 250 mm at the outlet, which in turn should be positioned as near the supporting wall as possible;
- preferably project 500 mm in order to provide adequate leg room underneath the basin.

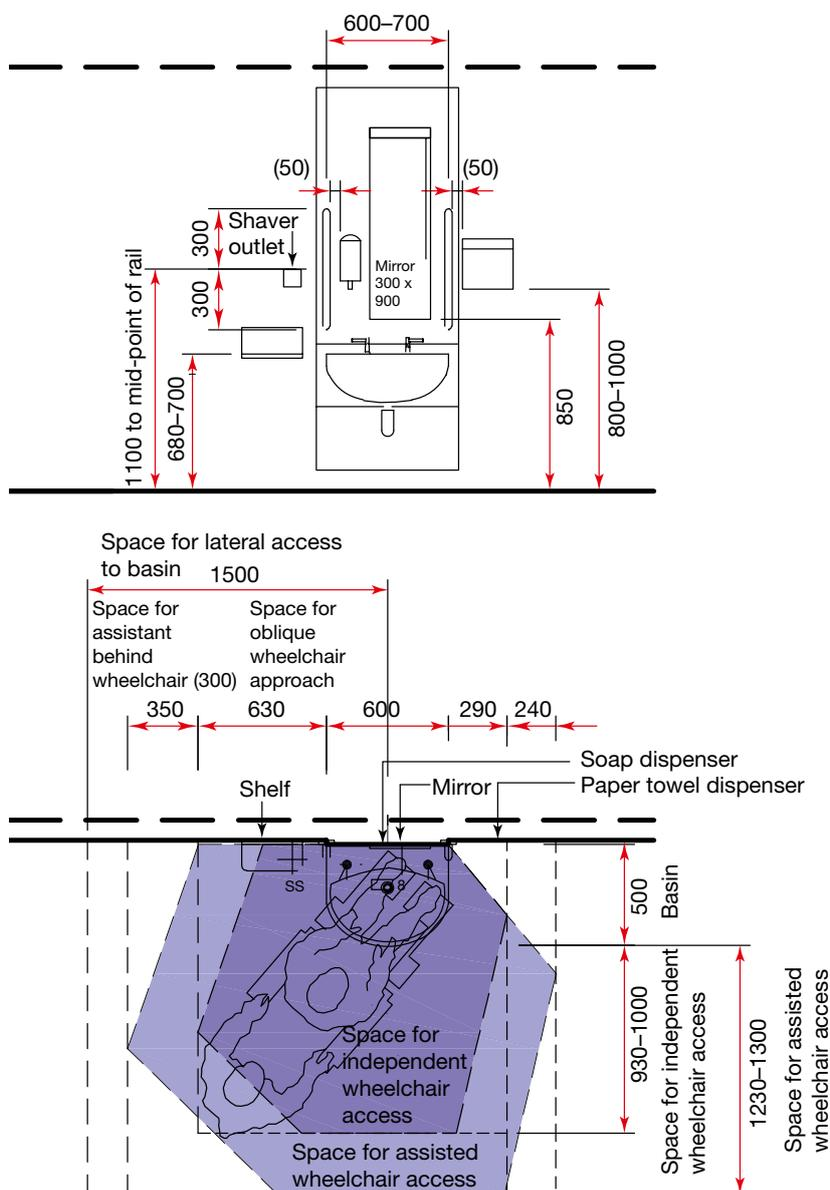

Figure 41 Space requirements for wheelchair accessible wash-hand basin, suitable for seated use

Full-length mirror: standing or seated users

4.26 This ergonomic drawing (see Figure 42) shows the space requirements for a full-length mirror for standing or seated users.

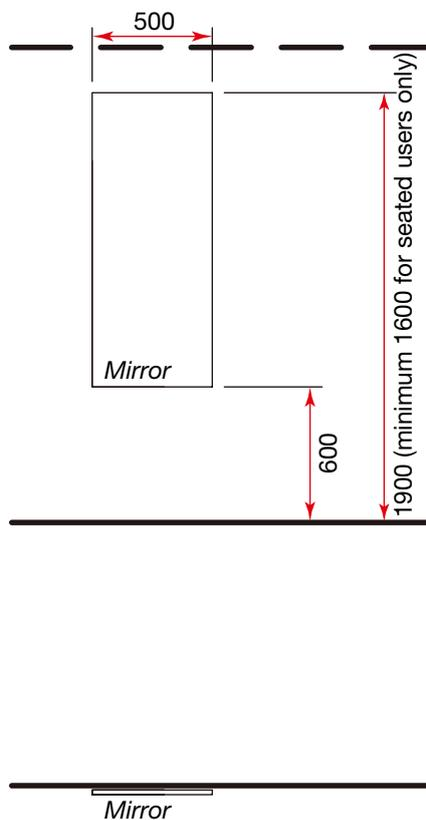

Figure 42 Space requirements for wheelchair accessible wash-hand basin, suitable for seated use

Shower room: en-suite: chamfered

Room description and layout

4.27 The following activities take place in chamfered en-suite shower rooms:

- assisted wheelchair, sanitary chair and shower chair access to the toilet, wash-hand basin and shower;
- mobile hoist access to transfer a patient to the toilet or shower seat or to attend to a patient collapsed on the floor;
- patient transfer from a wheelchair to the toilet or shower seat (supervised only);

- independent transfer from a wheelchair to the toilet or shower seat;
- use of the toilet;
- personal washing;
- showering (whilst seated).

4.28 The room layout provided (see Figures 43 and 44–45) is a variation on the en-suite shower room with a reduction in the shower room area but no saving on overall area when combined with a single-bed room.

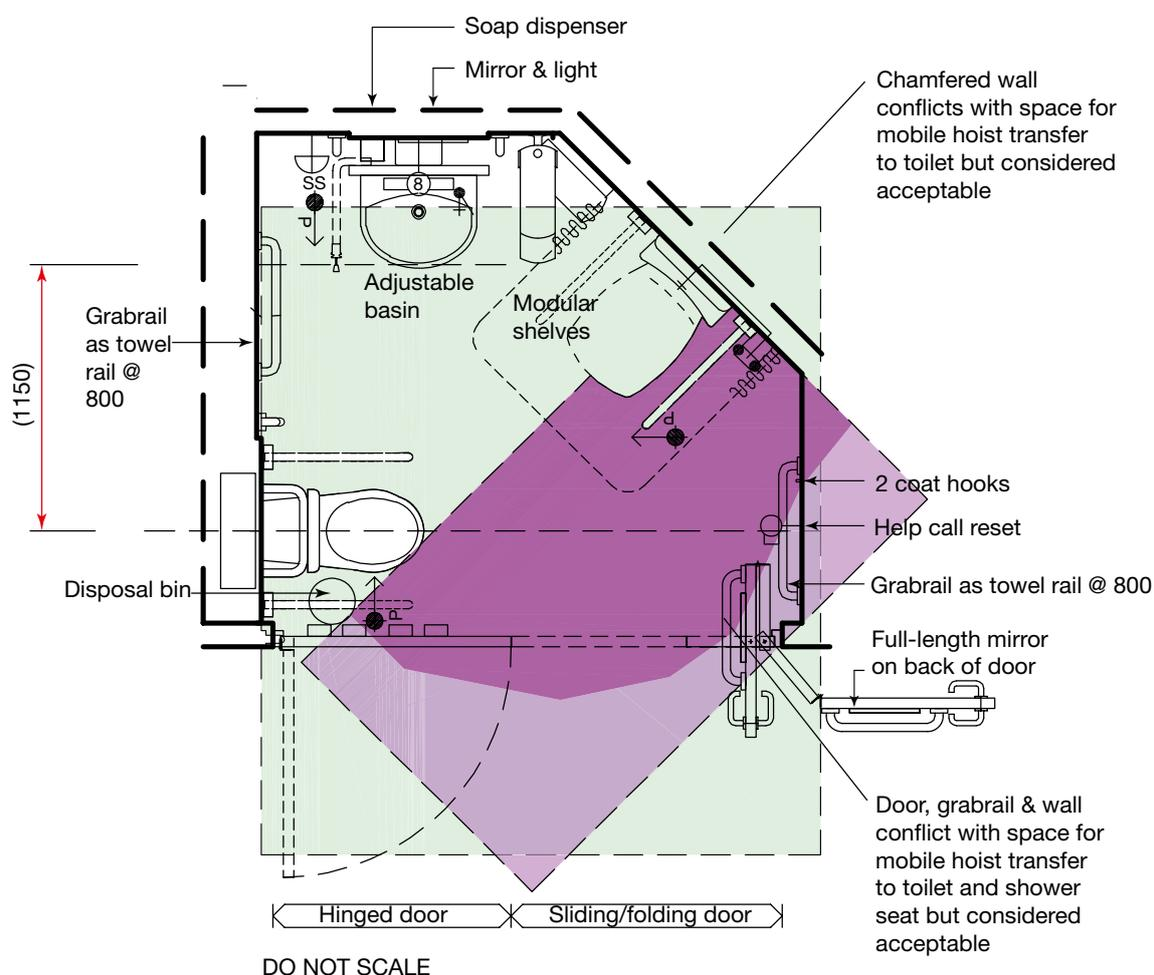

Figure 43 Shower room: en-suite: chamfered: mobile hoist access

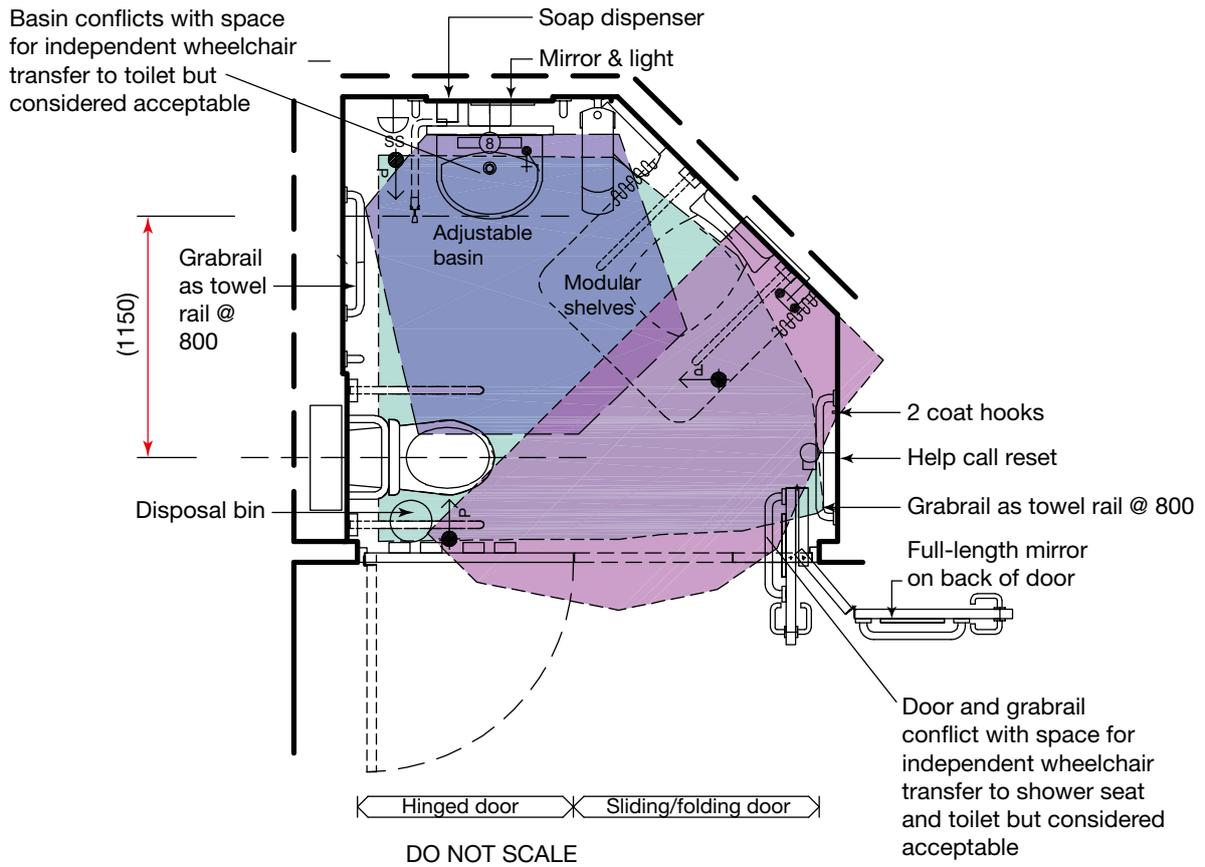

Figure 44 Shower room: en-suite: chamfered: assisted wheelchair access

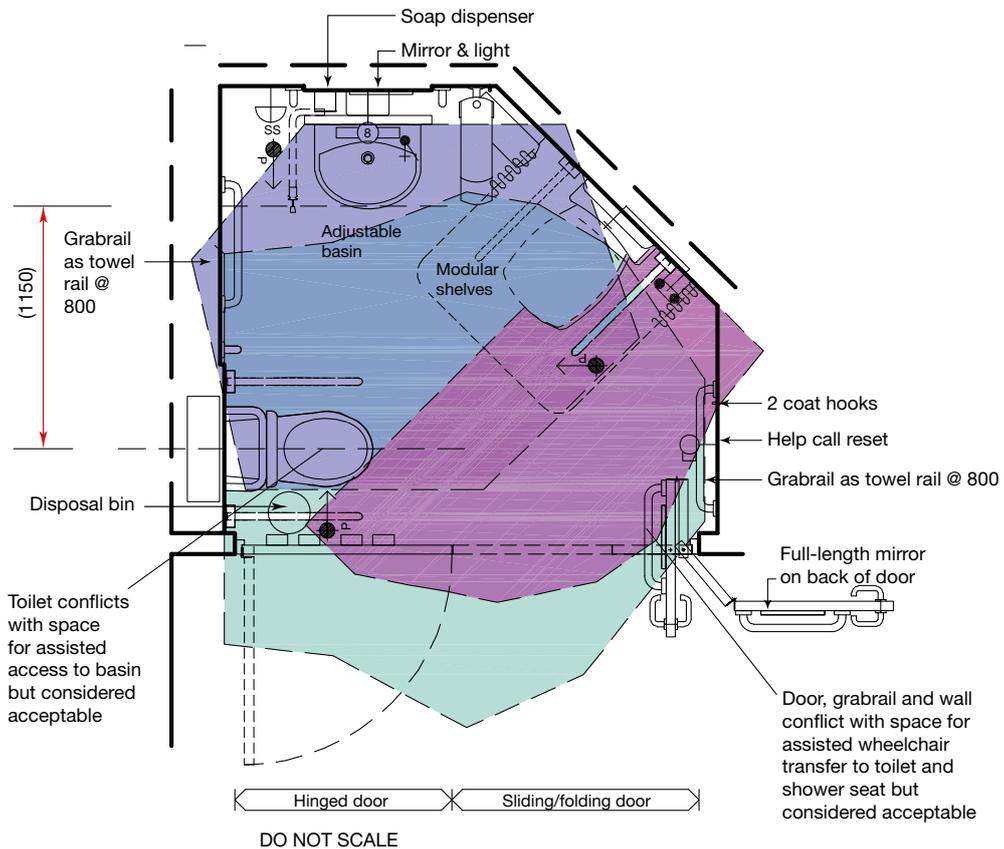

Figure 45 Shower room: en-suite: chamfered: independent wheelchair access

Ergonomic drawings

En-suite toilet

4.29 This ergonomic drawing (see Figure 46) shows the space requirements for an en-suite toilet (as used in the en-suite shower rooms).

4.30 The dispensers mounted on the back of the hinged door should not project more than approximately 50 mm (depending on the door design) to ensure they do not conflict with the use of the hinged grabrail between the door and the toilet pan.

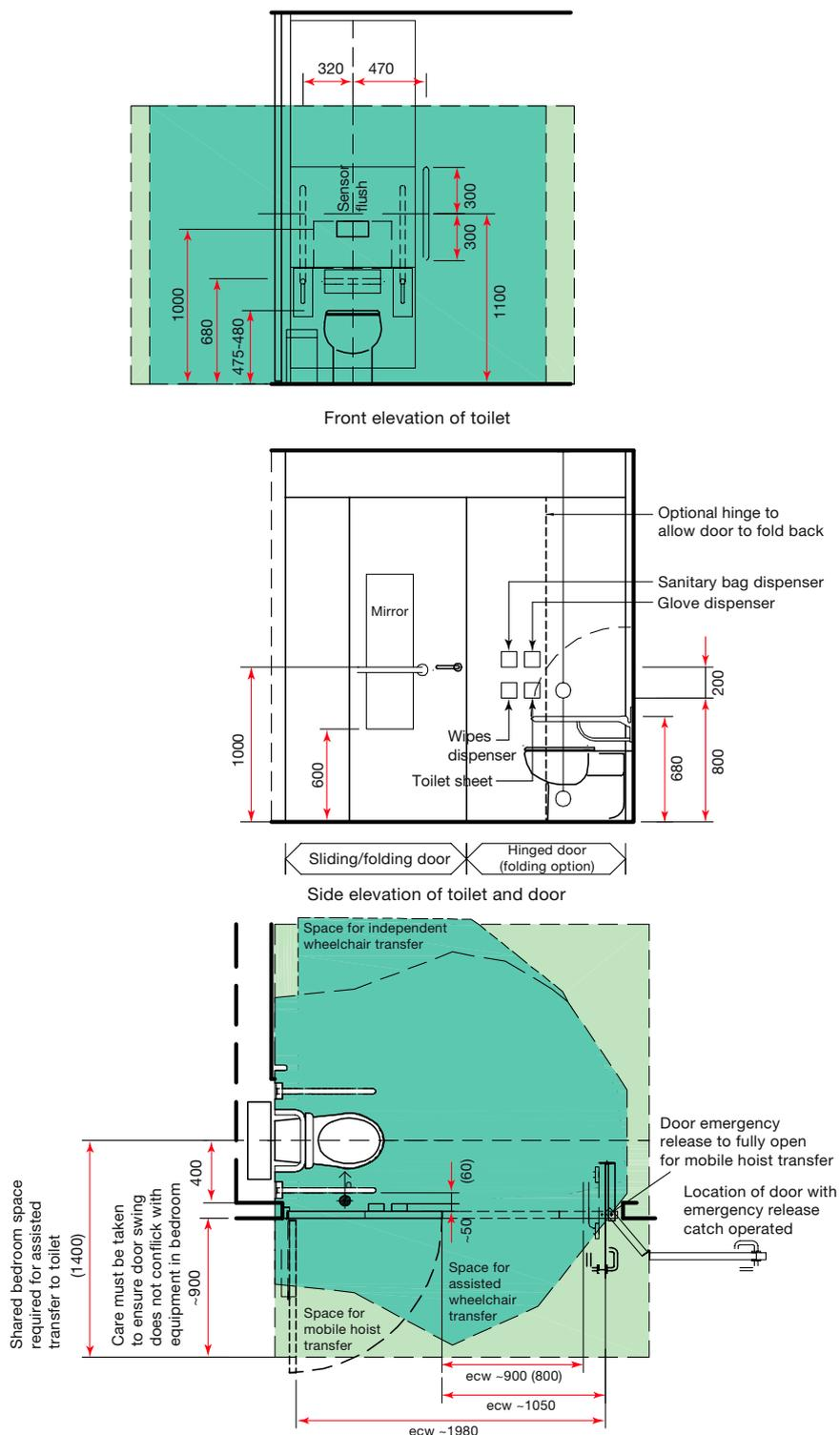

Figure 46 Space requirements for en-suite toilet

Adjustable-height wash-hand basin

4.31 This ergonomic drawing (see Figure 47) shows the space requirements for an adjustable-height wash-hand basin.

4.32 The position of the grabrails and fixtures should not conflict with the height-adjustment mechanism of the basin.

4.33 The general recommended lowest height of a mirror above a basin is 800 mm. However, 900 mm is acceptable where a lower height would conflict with the height-adjustment mechanism.

4.34 Consideration should be given to the choice of height-adjustment mechanism for ease of use; the controls should be accessible without interfering with normal access to the basin.

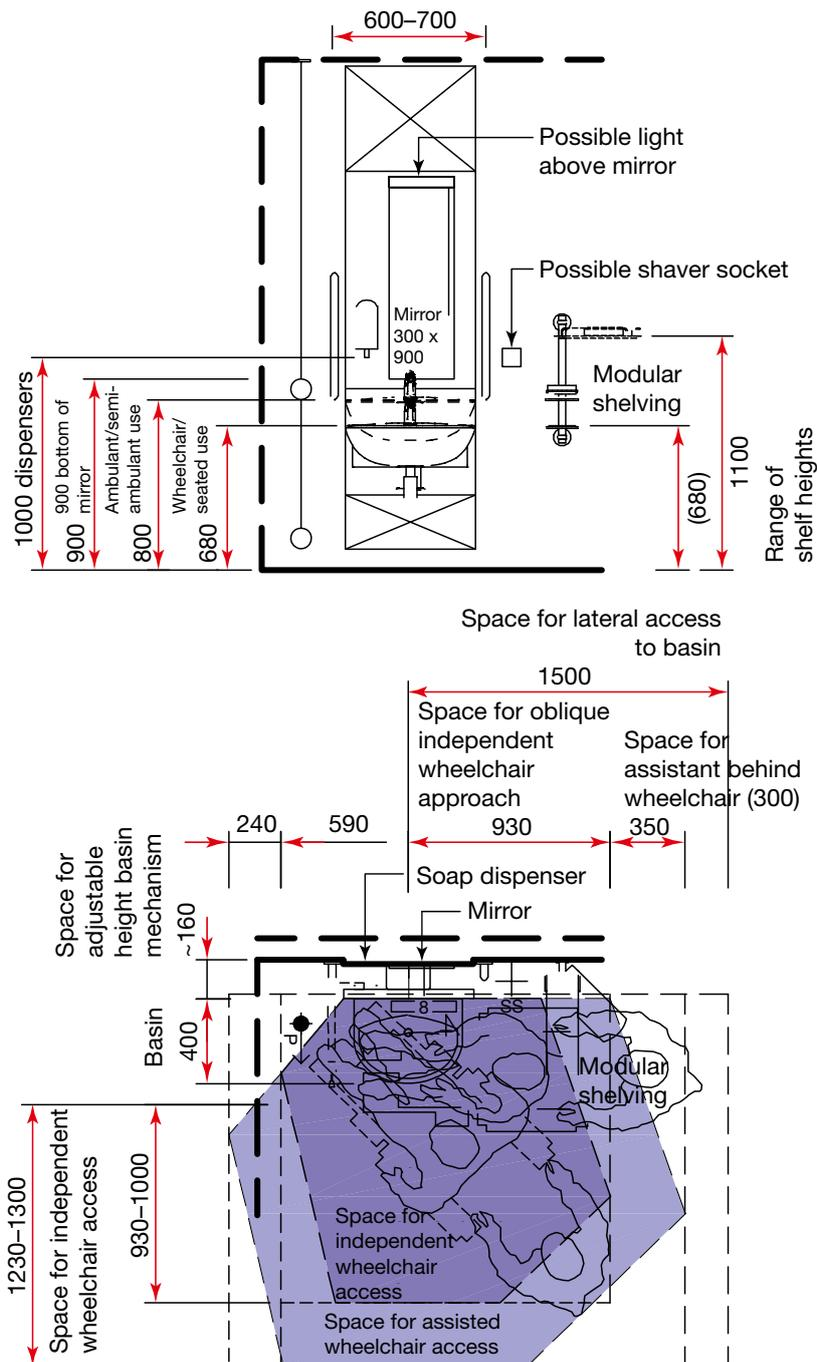

Figure 47 Space requirements for adjustable-height wash-hand basin

Shower for chamfered en-suite shower room

4.35 This ergonomic drawing (see Figure 48) shows the space requirements for the shower for use in the chamfered en-suite shower room.

4.36 Unassisted use of the shower may be limited because of the position of fixed shower controls on the back wall.

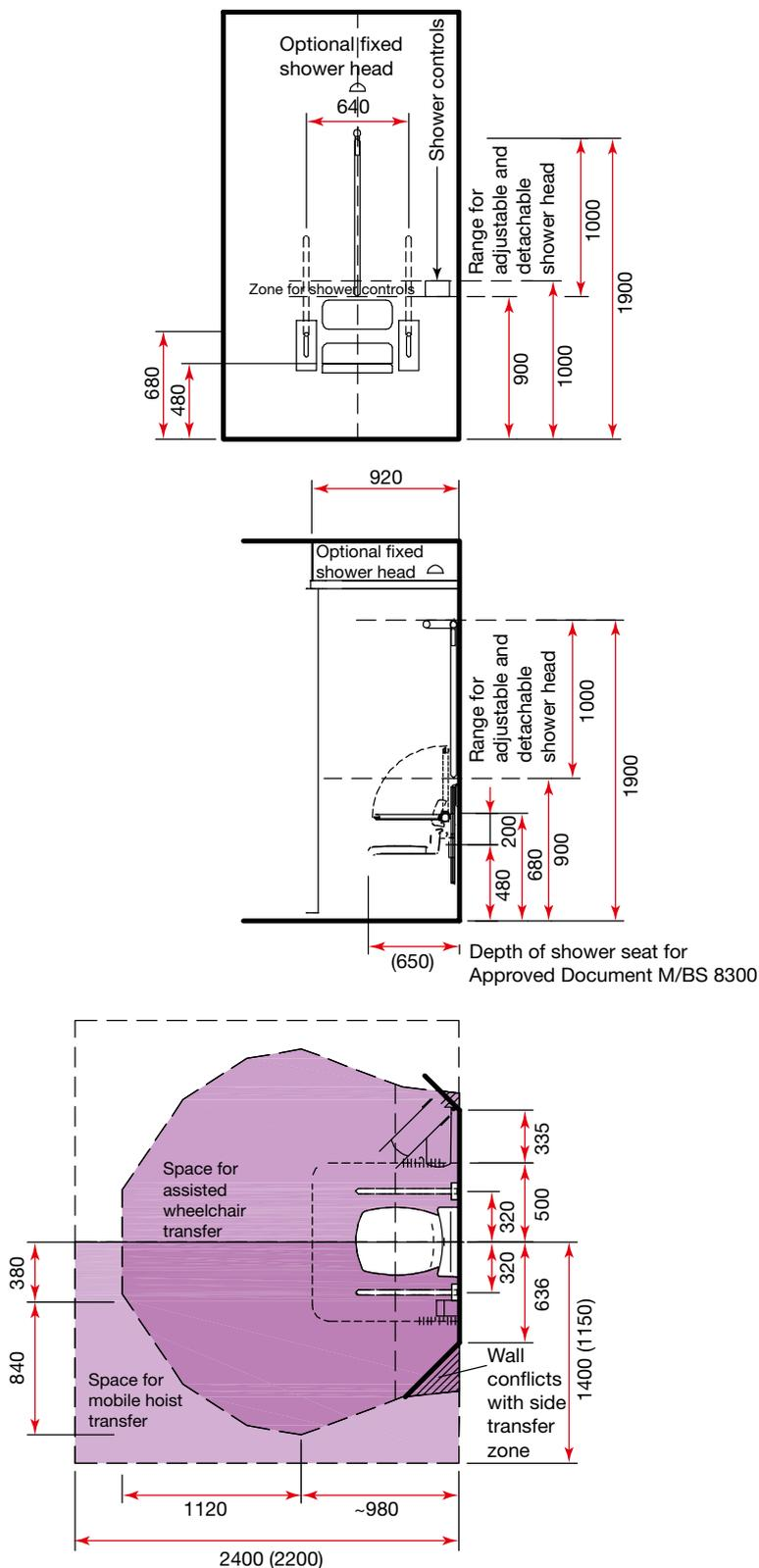

Figure 48 Space requirements for shower for use in chamfered en-suite shower room

Full-length mirror: standing or seated users

4.37 This ergonomic drawing (see Figure 49) shows the space requirements for a full-length mirror for standing or seated users.

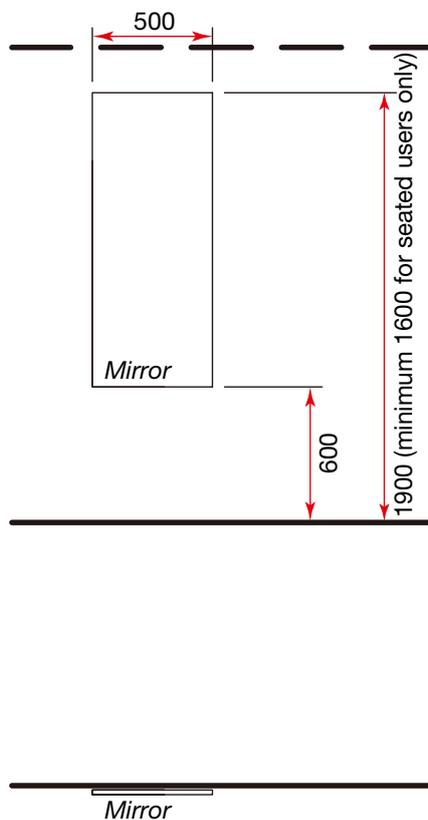

Figure 49 Space requirements for full-length mirror for standing or seated users

Shower room: en-suite

Room description and layout

4.38 The following activities take place in en-suite shower rooms:

- assisted wheelchair, sanitary chair and shower chair access to the toilet, wash-hand basin and shower;
- mobile hoist access to transfer a patient to the toilet or shower seat or to attend to a patient collapsed on the floor;
- patient transfer from a wheelchair to the toilet or shower seat (independent or supervised);
- use of the toilet;
- personal washing;
- showering (whilst seated).

4.39 The room layout provided (see Figure 60) shows a shower room and part of the adjoining single-bed room. The adjoining room is required to provide the necessary space for assistance and to maintain patient privacy.

4.40 The double door to the shower room consists of a sliding/folding door and a hinged door. The sliding/folding door provides staff and unassisted patient access. Both doors need to be fully open for assisted use of the facilities.

4.41 The sliding/folding door is designed to release from the overhead track in order to provide mobile hoist access to the room and transfer to one side of the toilet.

4.42 A roller catch may be provided on the sliding/ folding door rather than the lever handle indicated.

4.43 The hinged door should be able to open unhindered. To maximise the free space in the bedroom, consideration should be given to making this a folding door.

4.44 Assisted wheelchair and hoist transfer to the shower seat is only possible from the right-hand side of the shower (if facing the shower).

4.45 The room layout (see Figure 50) utilises the minimum clear space requirement to the side of the toilet for mobile hoist transfer (that is, 1150 mm from the centreline of the toilet to the nearest obstruction), on the basin side of the toilet only.

4.46 This is less than that generally recommended for right-hand independent wheelchair transfer to the toilet but was considered acceptable in the mock-up trials and complies with Approved Document M.

4.47 The clear space in front of the toilet is less than that generally recommended for mobile hoist transfer but was considered acceptable in the mock-up trials.

4.48 The room layout includes an adjustable tip-up shower seat. This is to allow for both non-assisted and assisted showering. The position of the shower seat should be adjusted between uses as required.

4.49 A depth of approximately 160 mm has been allowed for the height-adjustment mechanism on the basin. Where a greater depth is required, the internal room dimensions may need to increase or the room layout may need to be altered to maintain the required activity space.

4.50 The shower rooms are assumed to be wet rooms. The slope of the floor and location of the floor gully should ensure that water does not escape into the adjoining bedroom.

4.51 Where the en-suite is intended for independent wheelchair use, call reset buttons should be located near to the toilet (on the back of the door).

4.52 The disposal bin, adjacent to the toilet, should be a maximum of 200 mm wide and 480 mm high and capable of being operated with one hand.

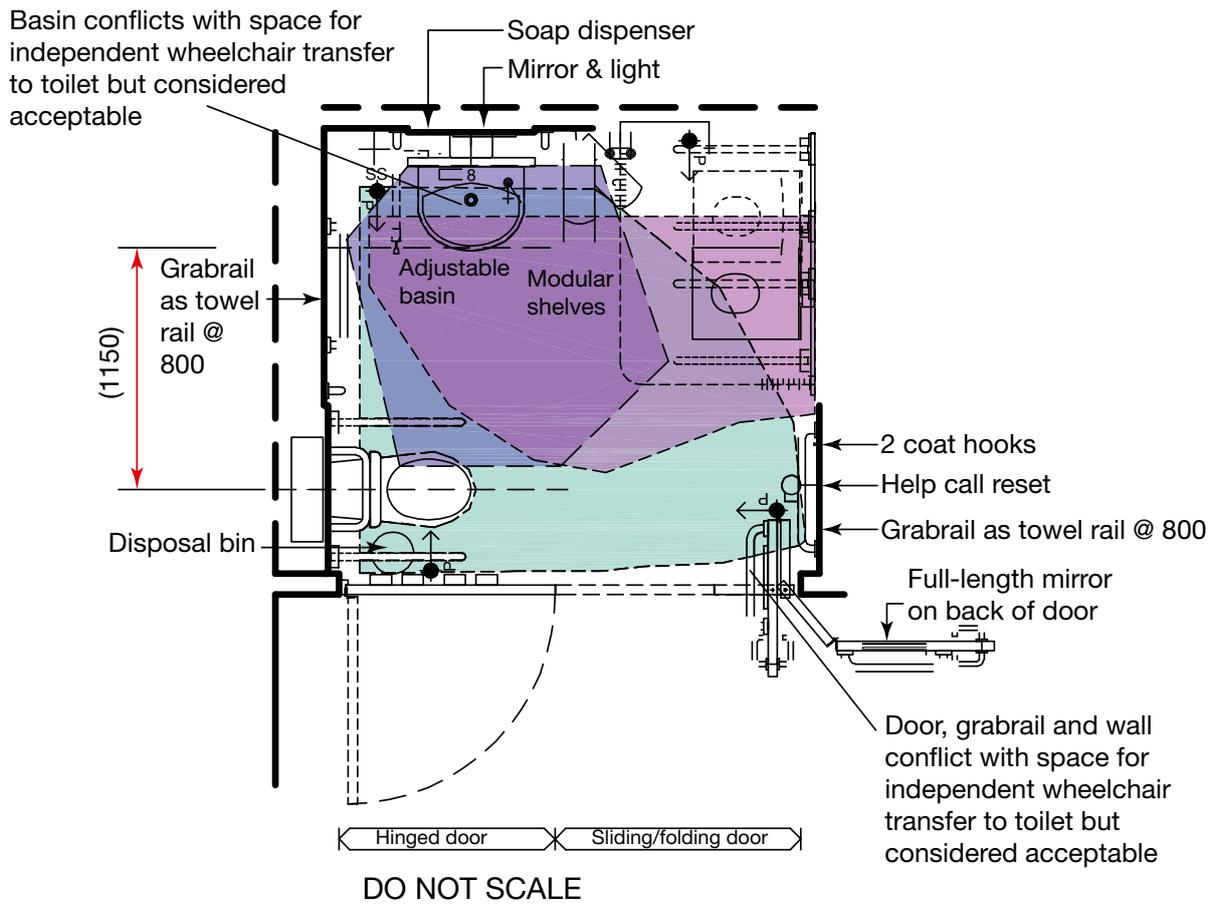

Figure 50 Space requirements for shower room: en-suite

Ergonomic drawings

En-suite toilet

4.53 This ergonomic drawing (see Figure 51) shows the space requirements for an en-suite toilet (as used in the en-suite shower rooms).

4.54 The dispensers mounted on the back of the hinged door should not project more than approximately 50 mm (depending on the door design) to ensure they do not conflict with the use of the hinged grabrail between the door and the toilet pan.

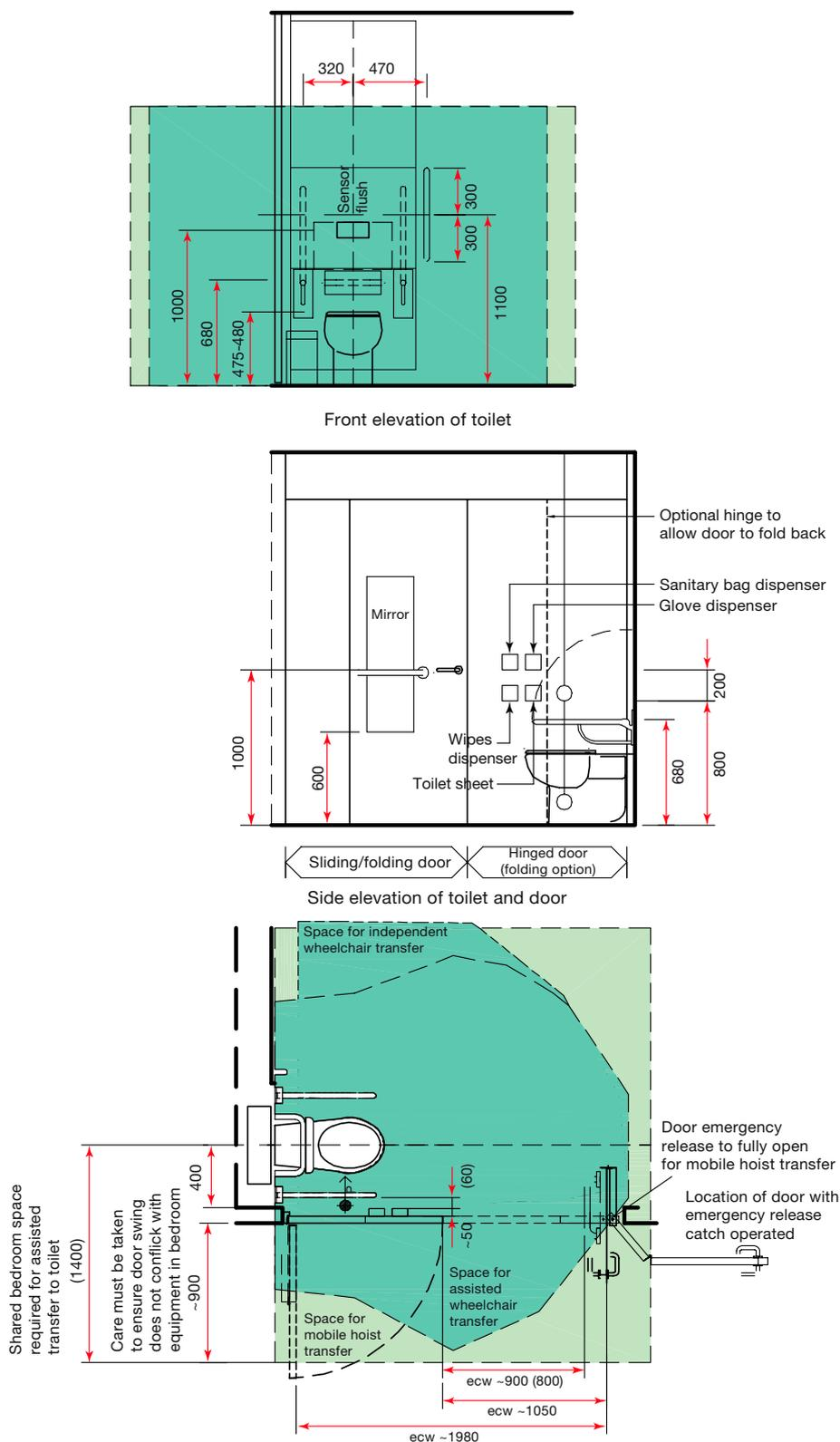

Figure 51 Space requirements for adjustable-height wash-hand basin

Adjustable-height wash-hand basin

4.55 This ergonomic drawing (see Figure 52) shows the space requirements for an adjustable-height wash-hand basin.

4.56 The position of the grabrails and fixtures should not conflict with the height-adjustment mechanism of the basin.

4.57 The general recommended lowest height of a mirror above a basin is 800 mm. However, 900 mm is acceptable where a lower height would conflict with the height-adjustment mechanism.

4.58 Consideration should be given to the choice of height-adjustment mechanism for ease of use; the controls should be accessible without interfering with normal access to the basin.

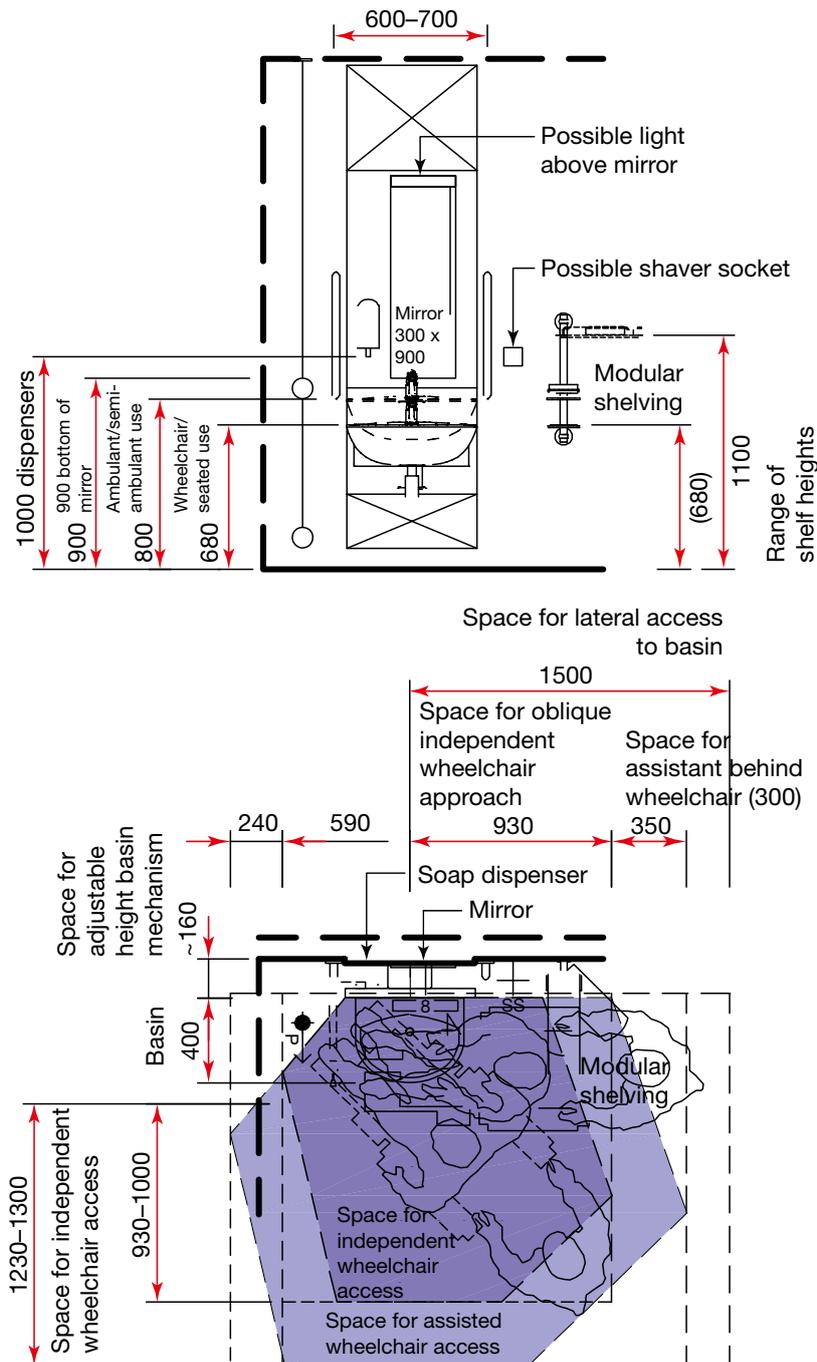

Figure 52 Space requirements for adjustable-height wash-hand basin

Shower with adjustable tip-up shower seat

4.59 This ergonomic drawing (see Figure 53) shows the space requirements for a shower with an adjustable tip-up shower seat.

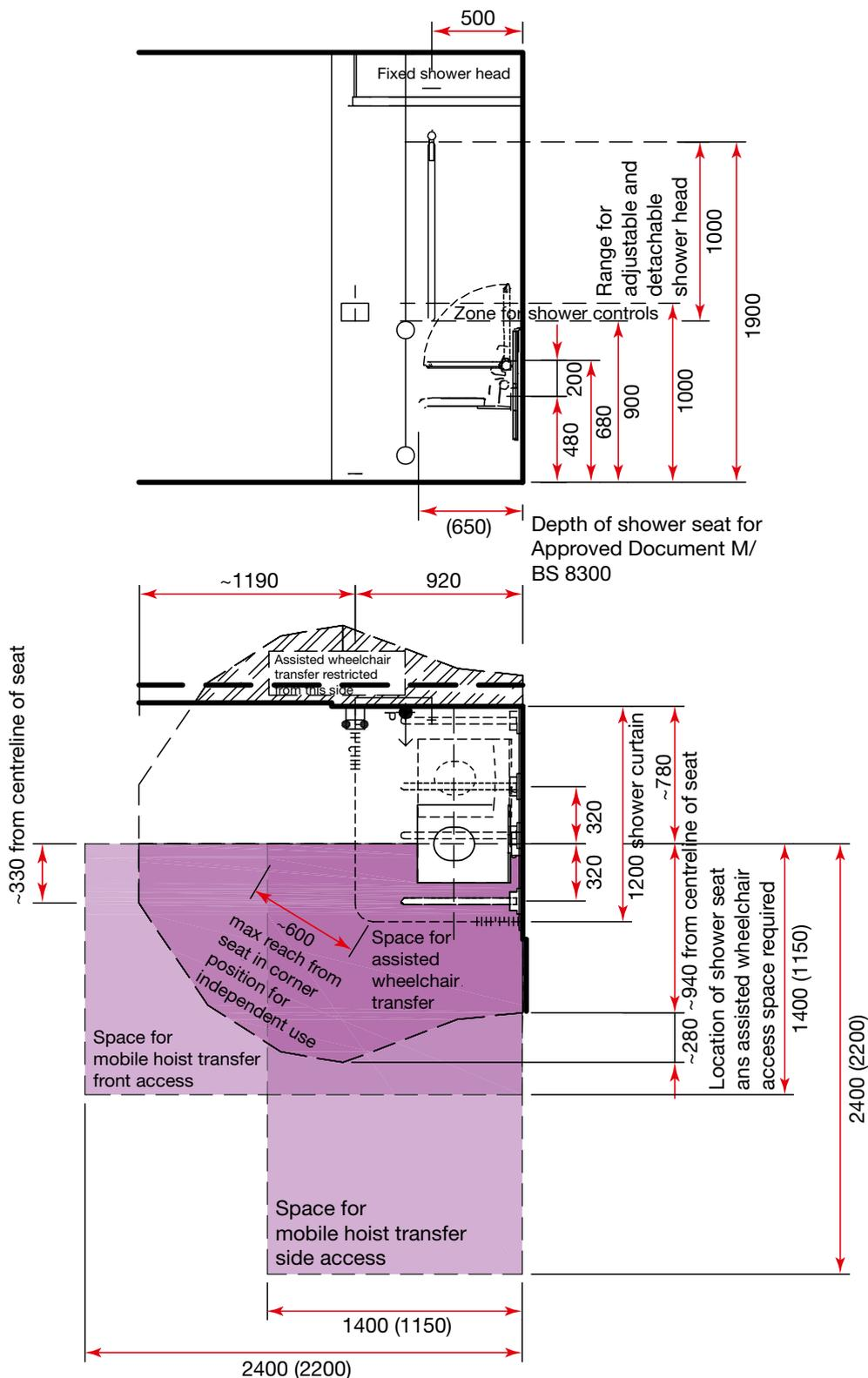

Figure 53 Space requirements for shower with adjustable tip-up shower seat

Full-length mirror: standing or seated users

4.60 This ergonomic drawing (see Figure 54) shows the space requirements for a full-length mirror for standing or seated users.

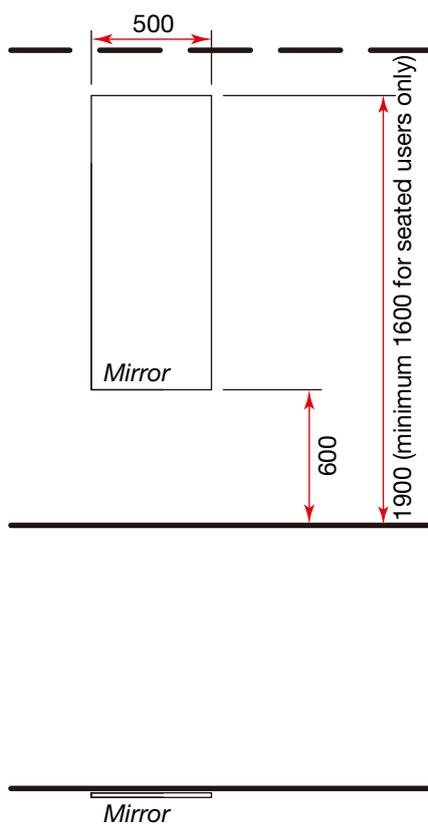

Figure 54 Space requirements for full-length mirror for standing or seated users

Shower room: independent wheelchair

Room description and layout

4.61 The following activities take place in independent shower rooms:

- undressing and dressing;
- hanging/holding clothes;
- wheelchair access to the toilet, hand-rinse basin, wash-hand basin and shower seat;
- independent transfer from a wheelchair to the toilet or shower seat;
- use of the toilet;
- disposal of sanitary towels and wipes;
- emptying of urine bottles and colostomy bags;
- hand-rinsing (whilst in a wheelchair facing the hand-rinse basin or seated on the toilet);
- personal washing (whilst seated);
- showering (whilst seated).

4.62 Independent shower rooms should contain an independent wheelchair toilet with adjacent hand-rinse basin, and separate wheelchair wash-hand basin for personal washing.

4.63 This facility is also suitable for semi-ambulant users with, or without, “hands-off assistance” who may wish to sit down to wash their hands when using the toilet or whilst showering.

4.64 In healthcare premises, for the privacy and dignity of patients, it is generally considered preferable for shower rooms to include a toilet. It may be acceptable to provide an independent wheelchair shower room without toilet facilities in staff-only areas.

4.65 The room layout provided (see Figure 55) allows for right-hand independent wheelchair transfer to the toilet and shower seat. Where more than one independent wheelchair shower room is provided, both left-hand and right-hand transfer options should be available.

4.66 To enable this space to be suitable for all unassisted use, an adjustable-height wash-hand basin may be provided in place of the wheelchair wash-hand basin.

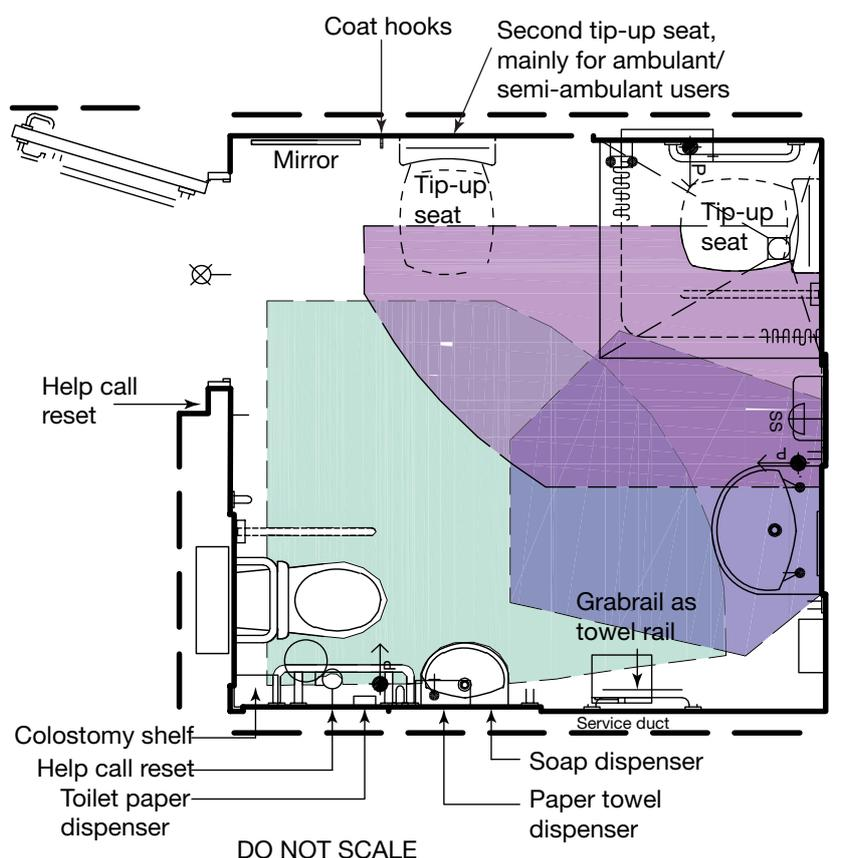

Figure 55 Space requirements for shower room: independent wheelchair

Independent wheelchair shower

4.67 This ergonomic drawing (see Figure 56) shows the space requirements for an independent wheelchair shower.

4.68 BS 8300 recommends a hinged grabrail at right-angles in front of shower seats for independent wheelchair transfer. This grabrail is to help prevent users falling forward. This rail is not considered necessary in healthcare premises. However, a risk assessment is recommended to confirm requirements.

4.69 The shower curtain consists of two parts to assist seated users to close the curtain, that is, to draw one half of the curtain from either side. The locations of the shower curtains and shower controls conflict with the recommendations in Approved Document M and BS 8300, and were informed by ergonomic studies and the mock-up trials for the en-suite shower rooms.

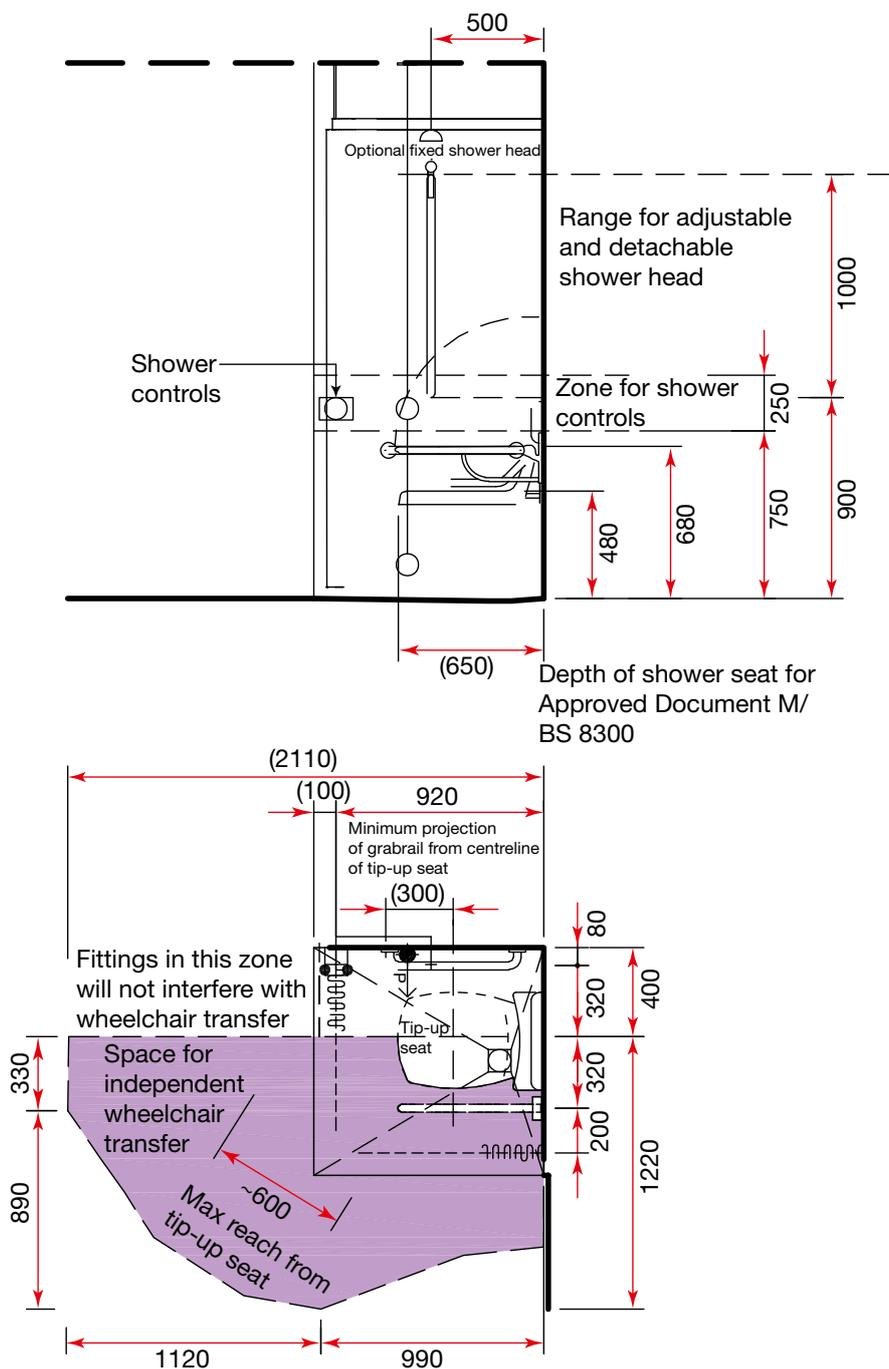

Figure 56 Space requirements for an independent wheelchair shower

*Toilet and adjacent hand-rinse basin:
independent wheelchair: grabrail options*

4.70 These ergonomic drawings (see Figure 57) show the fixing position of grabrails for an independent wheelchair toilet and adjacent hand-rinse basin.

4.71 Grabrails should be provided symmetrically on either side of the toilet at 320 mm from the centreline of the toilet pan. This conflicts with the recommendations in Approved Document M and BS 8300.

4.72 Approved Document M (paragraph 5.10j) states: “where the horizontal support rail on the wall adjacent to the toilet is set with the minimum spacing from the wall, an additional dropdown rail should be provided on the wall side at a distance of 320 mm from the centreline of the toilet.”

Note

Where the maximum spacing defined in Approved Document M, 85 mm, is used, this positions the grabrail approximately 390 mm from the centreline of the toilet, which is not symmetrical with the hinged grabrail on the other side.

4.73 BS 8300 (paragraph 12.6.3.5 b) states: “A fixed horizontal rail should be located on the side wall with a 50 mm to 60 mm clearance between the rail and the wall.” This places the rail approximately 420 mm from the centreline of the toilet, which is not symmetrical with the hinged grabrail on the other side.

4.74 The ergonomic drawings provided illustrate two options for the provision of grabrails. The room layouts on this website are based on option one.

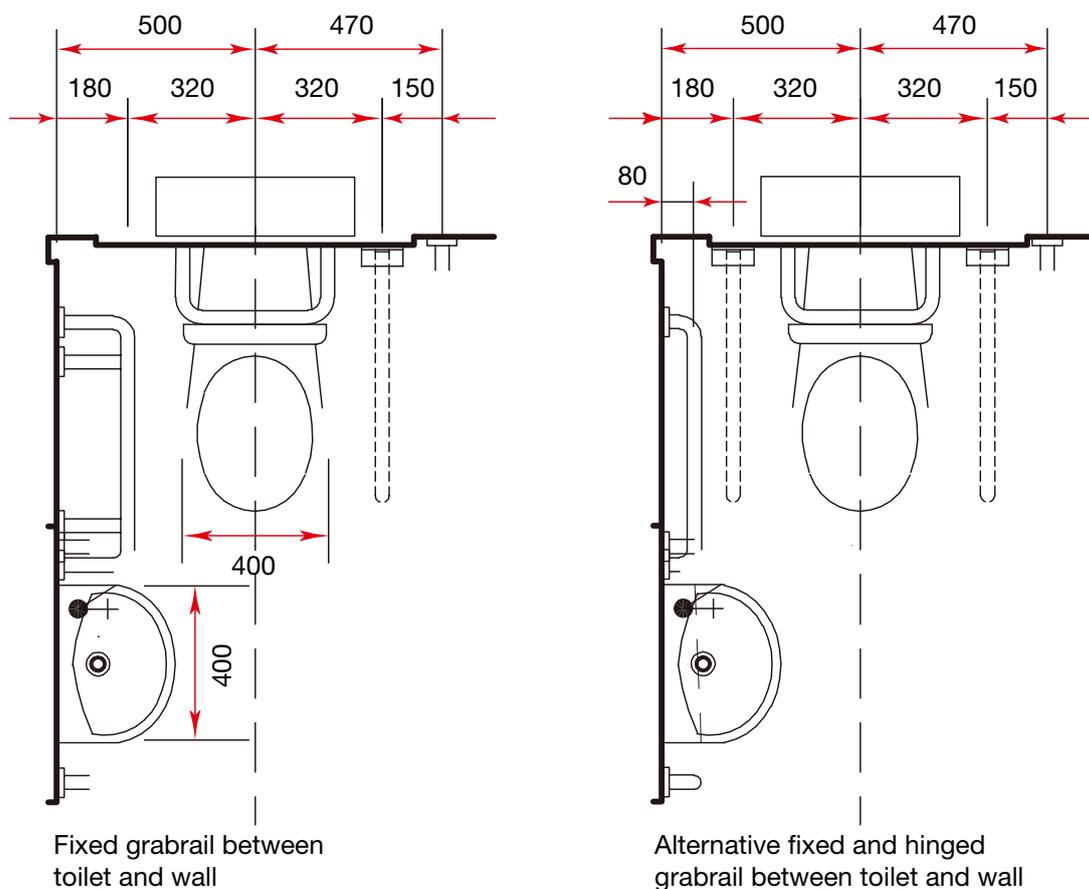

Figure 57 Space requirements showing fixing positions of grabrails for an independent wheelchair toilet and adjacent hand-rinse basin

Toilet and adjacent hand-rinse basin: independent wheelchair

4.75 This ergonomic drawing (see Figure 58) shows the space requirements for an independent wheelchair toilet and adjacent hand-rinse basin.

4.76 The recommended clear space in front and to the open side of the toilet (for independent wheelchair transfer) is greater than the recommendations in Approved Document M and BS 8300.

4.77 Approved Document M and BS 8300 recommend a minimum clear distance of 1000 mm to the open side of the centreline of the toilet for independent wheelchair transfer. Robert Feeney Associates (RFA) research for BS 8300 indicates that this will allow just over 60% of wheelchair users to comfortably transfer onto the toilet. The same research indicates that a clear space of 1400 mm accommodates 90% of wheelchair users and this is, therefore, recommended.

4.78 Approved Document M and BS 8300 recommend a 750 mm long toilet pan for independent wheelchair transfer. However, RFA research indicated that a 700 mm long toilet pan allows independent wheelchair transfer. For maximum space efficiency a 700 mm pan is recommended.

4.79 As a consequence of the reduction in pan length, the hand-rinse basin is located closer to the corner of the room than the position given in Approved Document M and BS 8300, to allow hand-rinsing from a seated position on the toilet.

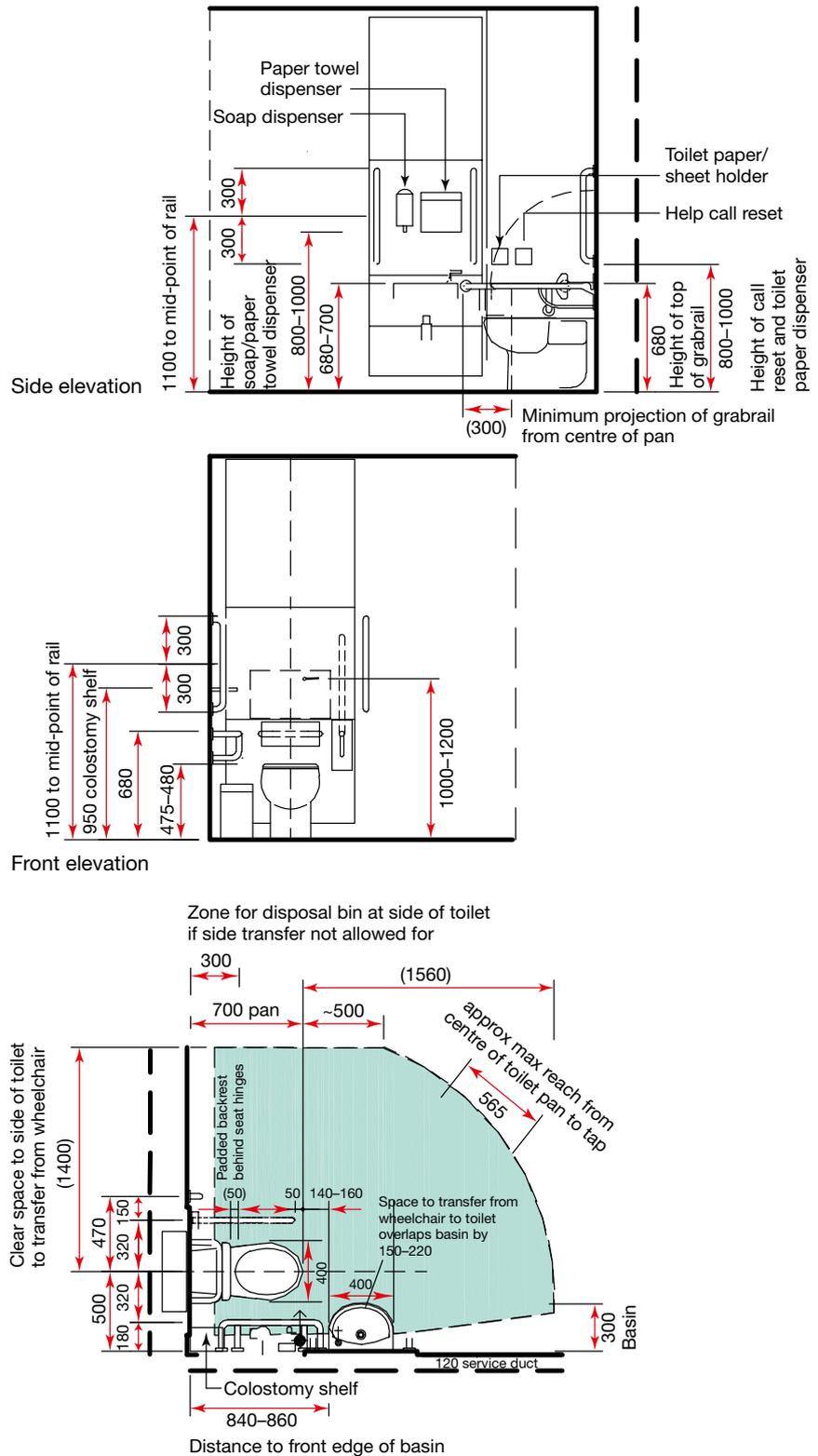

Figure 58 Space requirements for an independent wheelchair toilet and adjacent hand-rinse basin

Wash-hand basin: wheelchair

4.80 Wash-hand basins may be used for personal washing activities.

4.81 This ergonomic drawing (see Figure 59) shows the space requirements for a wheelchair accessible wash-hand basin. It is also suitable for seated use.

4.82 It includes a shaver socket adjacent to the wash-hand basin and a light above the mirror; these are optional. The inclusion of a shaver socket depends on project requirements. The need for a local light depends on the overall lighting scheme within the room.

4.83 The drawing also shows two short lever taps. Alternatively a single mixer tap or sensor-operated taps may be used. See Health Building Note 00-10 Part C – ‘Sanitary assemblies’ for details.

4.84 Wheelchair-accessible wash-hand basins should have a size and profile that maximises access and reduces obstructions. They should:

- be as shallow as possible, that is, tapered from the rim to a depth not exceeding 250 mm at the outlet, which in turn should be positioned as near the supporting wall as possible;
- preferably project 500 mm in order to provide adequate leg room underneath the basin.

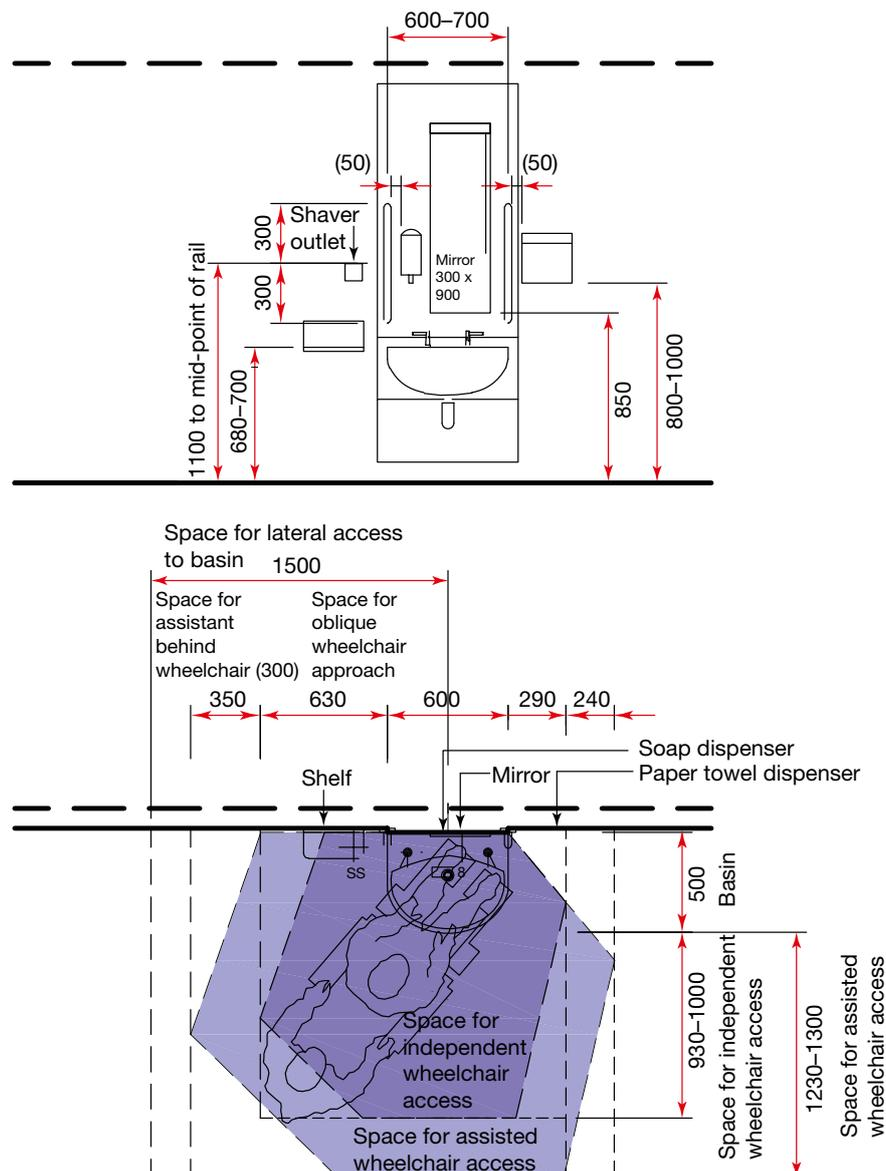

Figure 59 Space requirements for wheelchair accessible wash-hand basin

Full-length mirror: standing or seated users

4.85 This ergonomic drawing (see Figure 60) shows the space requirements for a full-length mirror for standing or seated users.

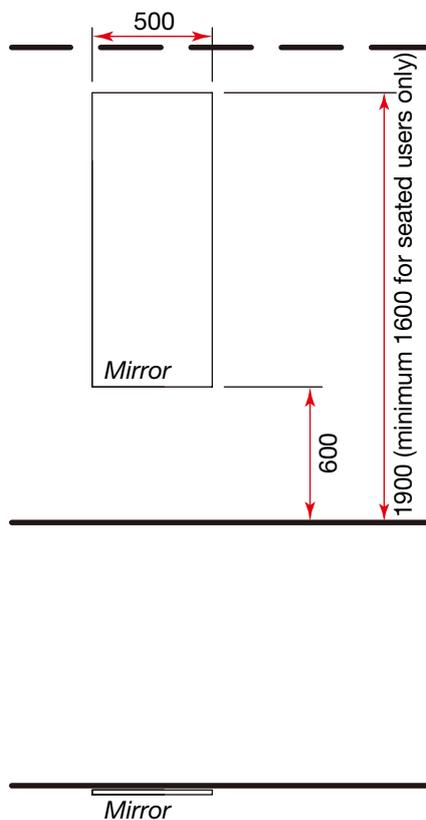

Figure 60 Space requirements for full-length mirror for standing or seated users

Shower room: semi-ambulant: standing use

Room description and layout

4.86 See Figure 61. The following activities take place in semi-ambulant shower rooms:

- undressing and dressing;
- hanging/holding clothes;
- use of the toilet;
- personal washing;
- showering (whilst standing).

4.87 Shower rooms for semi-ambulant use should contain a semi-ambulant toilet, ambulant wash-hand basin and a wet floor shower area (not a shower tray).

4.88 Semi-ambulant shower rooms are also suitable for ambulant users.

4.89 A continuous horizontal grabrail should be provided within the shower area. Users should be able to touch two sides of the shower area/two grabrails, opposite or at right angles, in order to keep their balance.

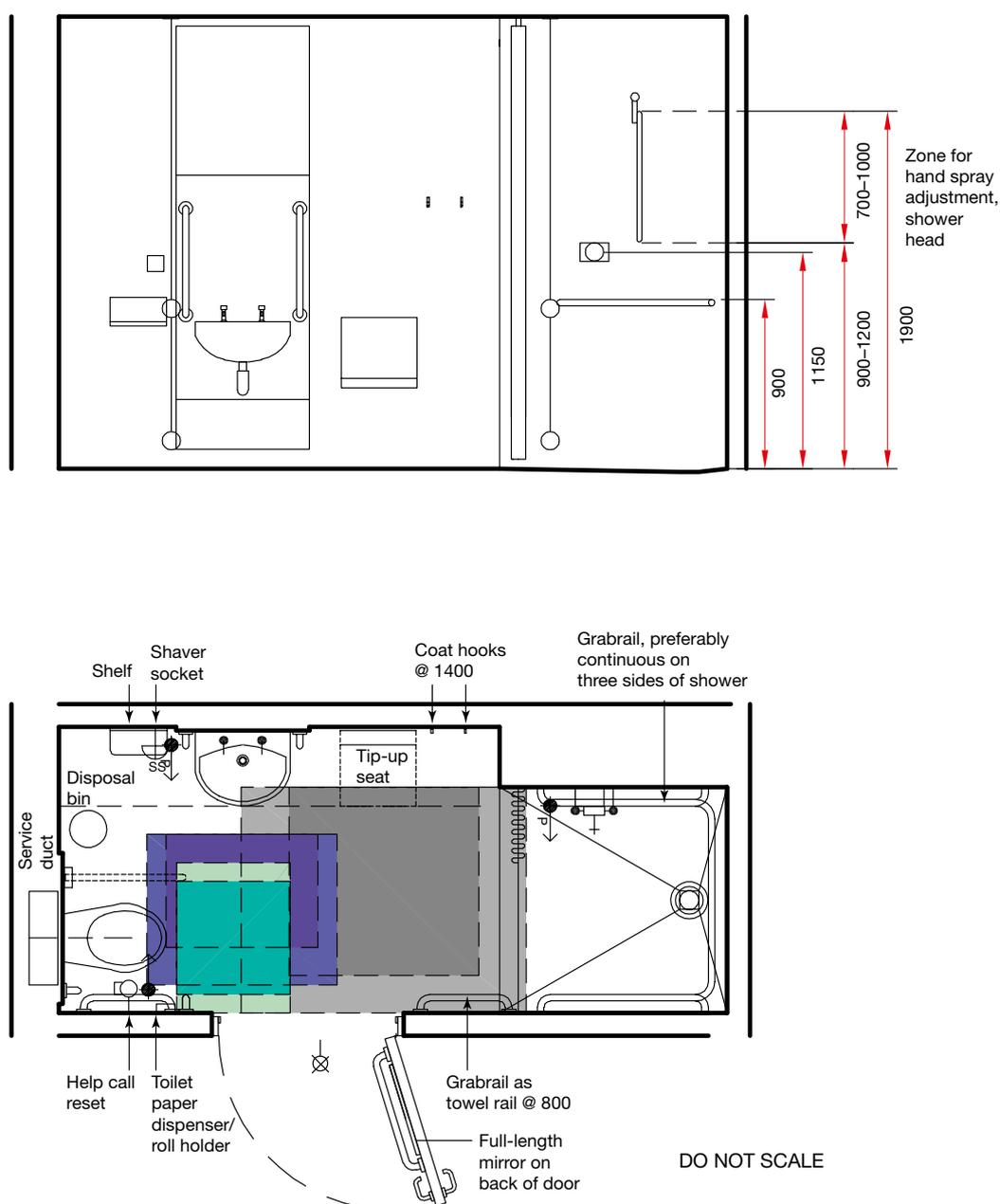

Figure 61 Space requirements for shower room: semi-ambulant: standing use

Ergonomic drawings

Toilet: semi-ambulant

4.90 This ergonomic drawing (see Figure 62) shows the space requirements for a semi-ambulant toilet.

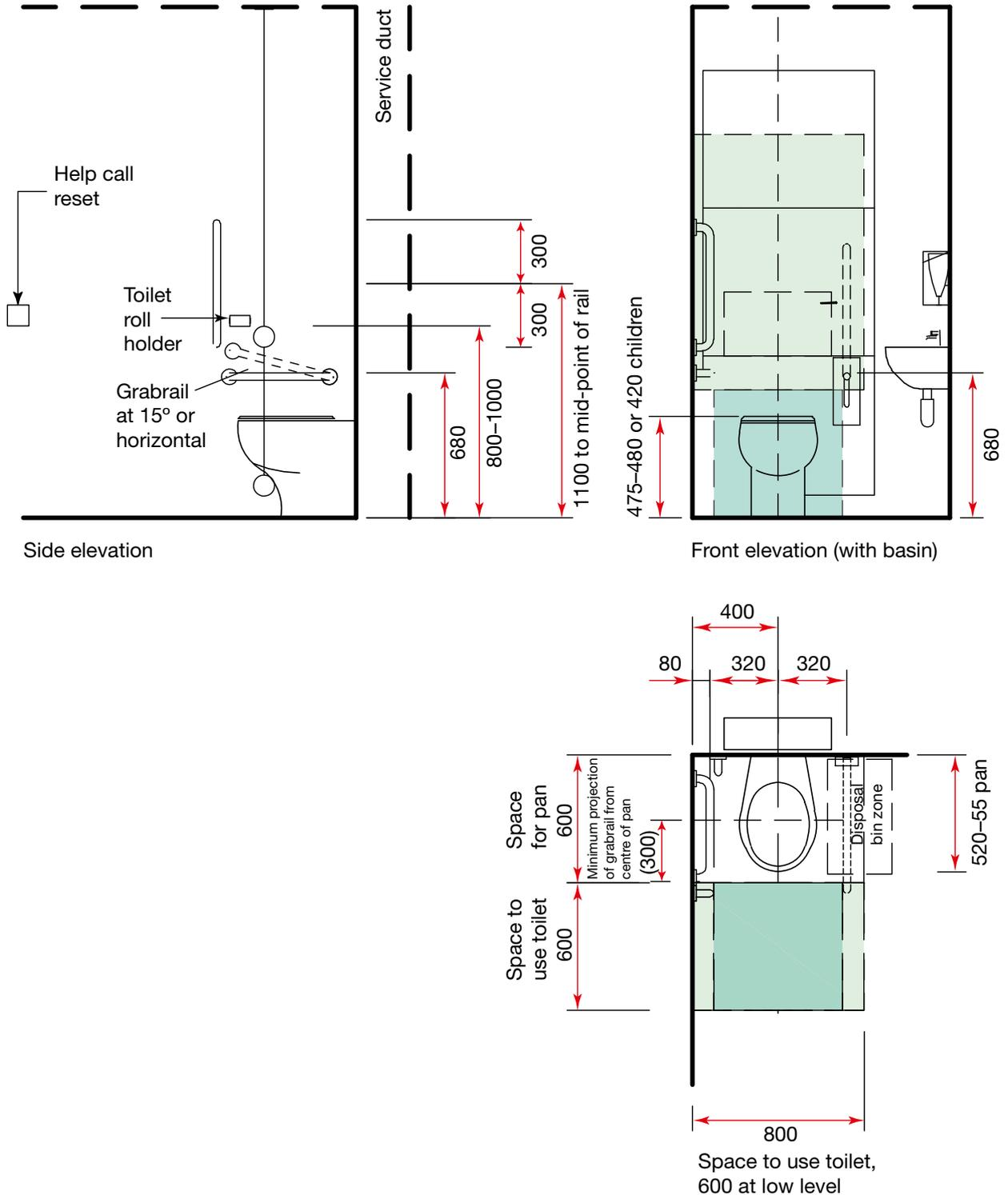

Figure 62 Space requirements for semi-ambulant toilet

Wash-hand basin: ambulant

4.91 Wash-hand basins may be used for personal washing activities.

4.92 This ergonomic drawing (see Figure 63) shows the space requirements for ambulant/semi-ambulant use of a 400 mm deep x 500 mm wide wash-hand basin.

4.93 It includes a shaver socket adjacent to the wash-hand basin and a light above

the mirror; these are optional. The inclusion of a shaver socket depends on project requirements. The need for a local light depends on the overall lighting scheme within the room.

4.94 The drawing also shows two short lever taps. Alternatively a single mixer tap or sensor-operated taps may be used. See Health Building Note 00-10 Part C – ‘Sanitary assemblies’ for details.

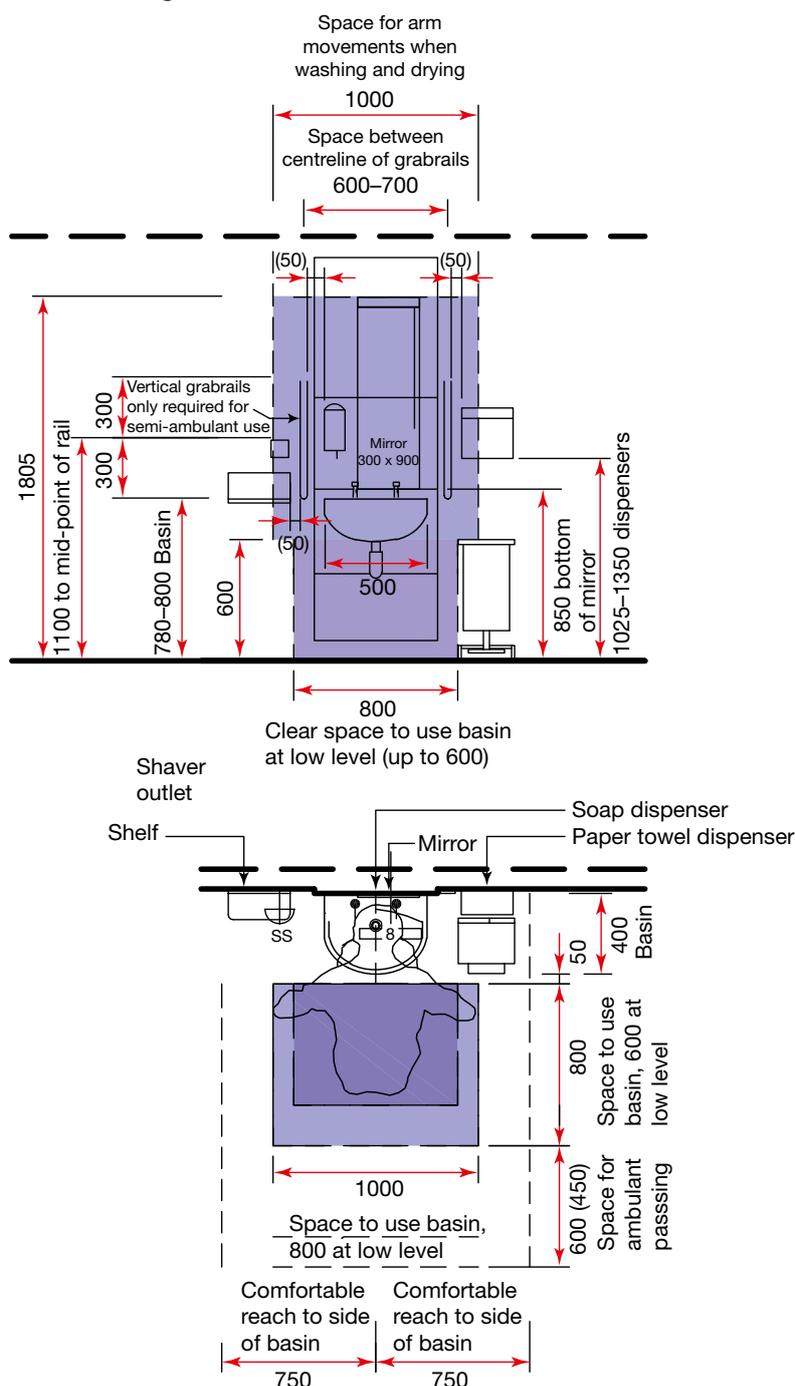

Figure 63 Space requirements for ambulant/semi-ambulant use of a 400 mm deep x 500 mm wide wash-hand basin

Full-length mirror: standing or seated users

4.95 This ergonomic drawing (see Figure 64) shows the space requirements for a full-length mirror for standing or seated users.

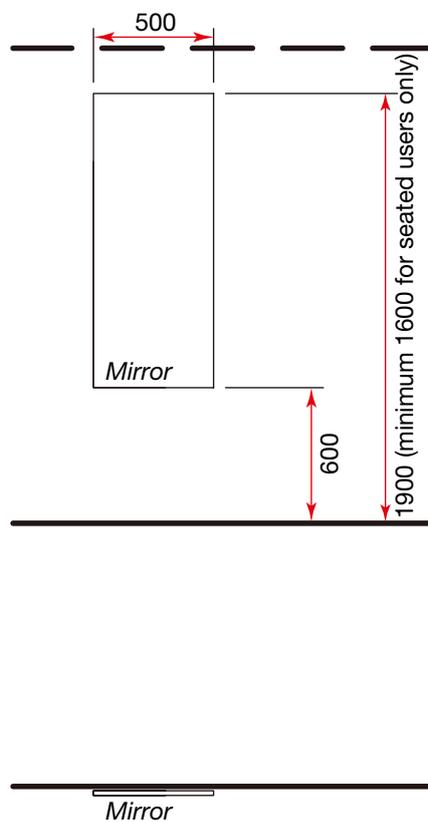

Figure 64 Space requirements for full-length mirror for standing or seated users

Dressing and undressing: ambulant

4.96 These ergonomic drawings (see Figure 65) show the space requirements for ambulant dressing and undressing.

4.97 An identical space provision is suitable for semi-ambulant users though it should be located adjacent to a seating area.

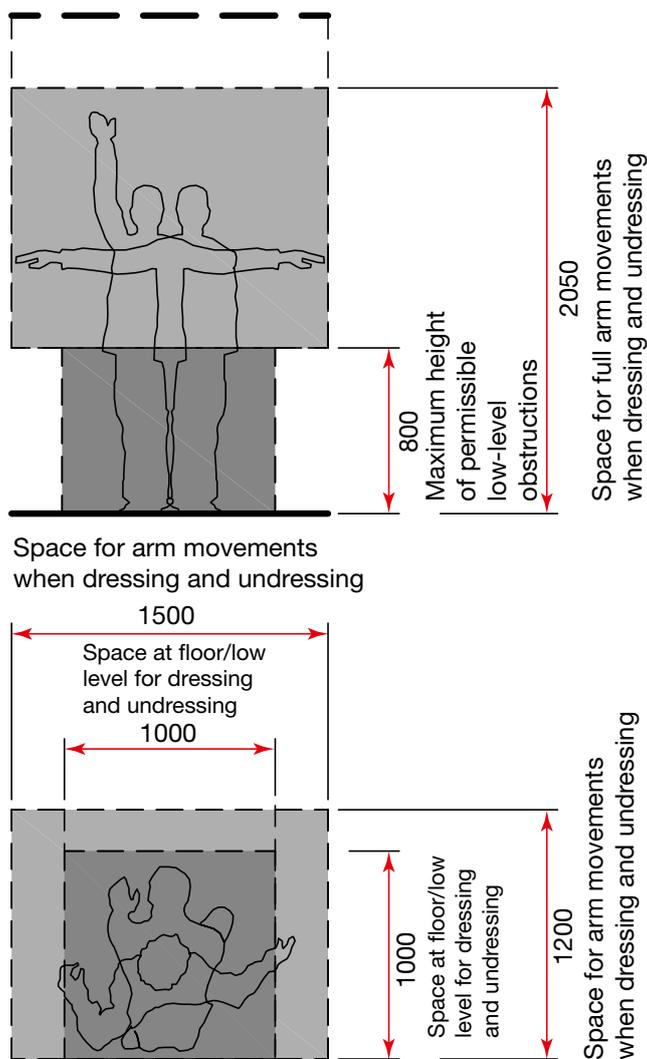

Figure 65 Space requirements for ambulant dressing and undressing

Shower room: trolley access

Room description and layout

4.98 The following assisted activities take place in trolley access shower rooms:

- wheelchair and sanitary chair access to the toilet and wash-hand basin;
- mobile hoist access to transfer a patient to the toilet or to attend to a patient collapsed on the floor;
- patient transfer from a wheelchair to the toilet (supervised only);
- use of the toilet;
- personal washing (whilst the patient is seated);

- shower trolley access to the shower;
- showering (whilst the patient is lying on the shower trolley).

4.99 Trolley access showers are suitable for patients who are reliant on assisted movement. The room layout provided (see Figure 66) utilises the minimum clear space requirement to the side of the toilet for mobile hoist transfer (that is, 1150 mm from the centreline of the toilet to the nearest obstruction), on the basin side of the toilet only.

4.100 It features two toilets: one in the wet area and the other in the dry area. The drainpipe at the foot of the shower trolley should be positioned over the toilet in the wet area to deal with incontinence episodes during showering.

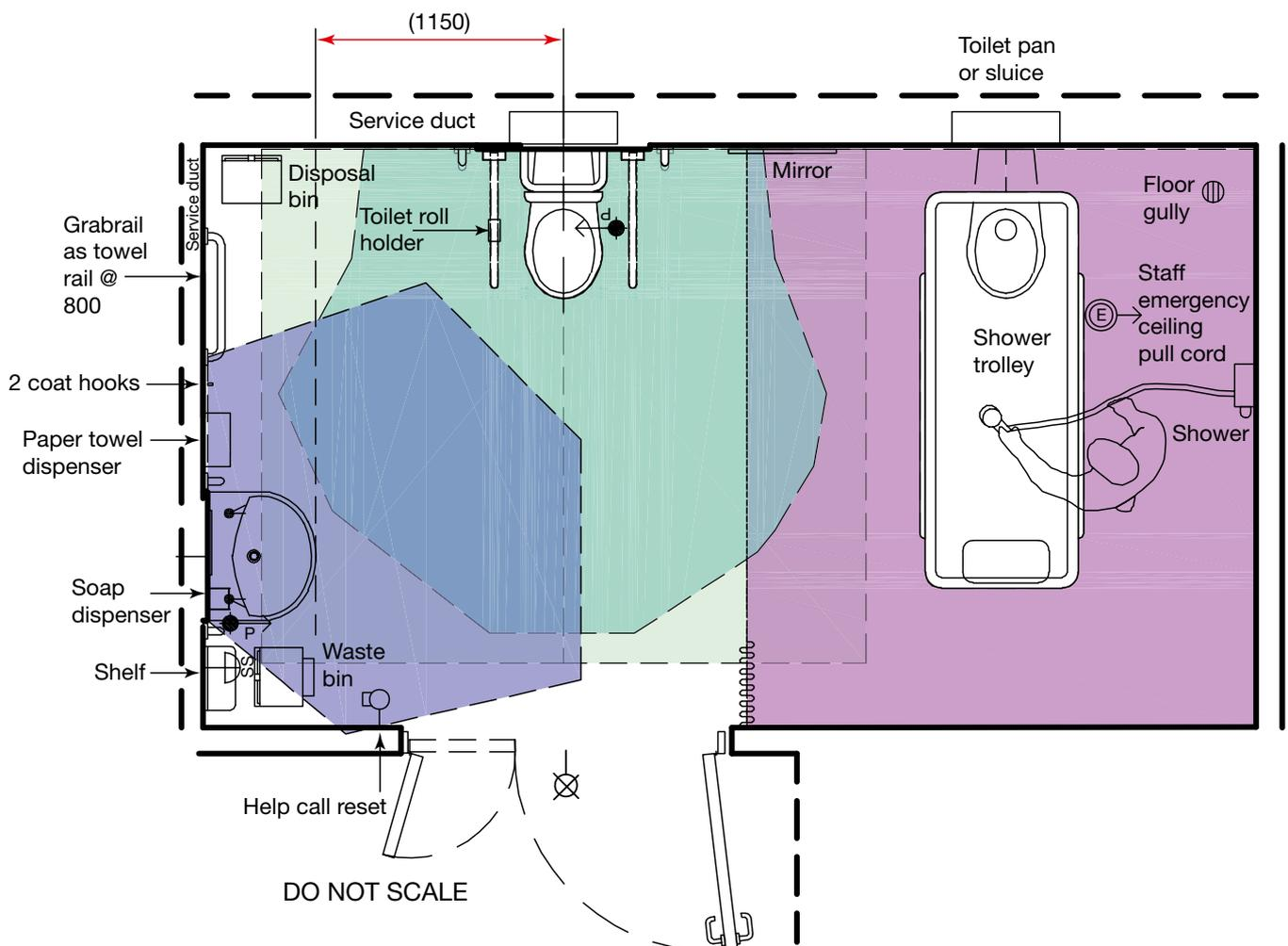

Figure 66 Space requirements for shower room: trolley access minimum space requirement

Ergonomic drawings

Trolley access shower

4.101 This ergonomic drawing (see Figure 67) shows the space requirements for a trolley access shower.

4.102 A minimum of 800 mm clear space at the head of the trolley is required if staff need to stand in this position during showering.

4.103 The shower panel should have a pressure and temperature control thermostatic mixer. The shower hose should be long enough to allow staff to shower the full length of the patient from either side with a trigger handle. This shower fitting is not specifically covered in Health Building Note 00-10 Part C – ‘Sanitary assemblies’.

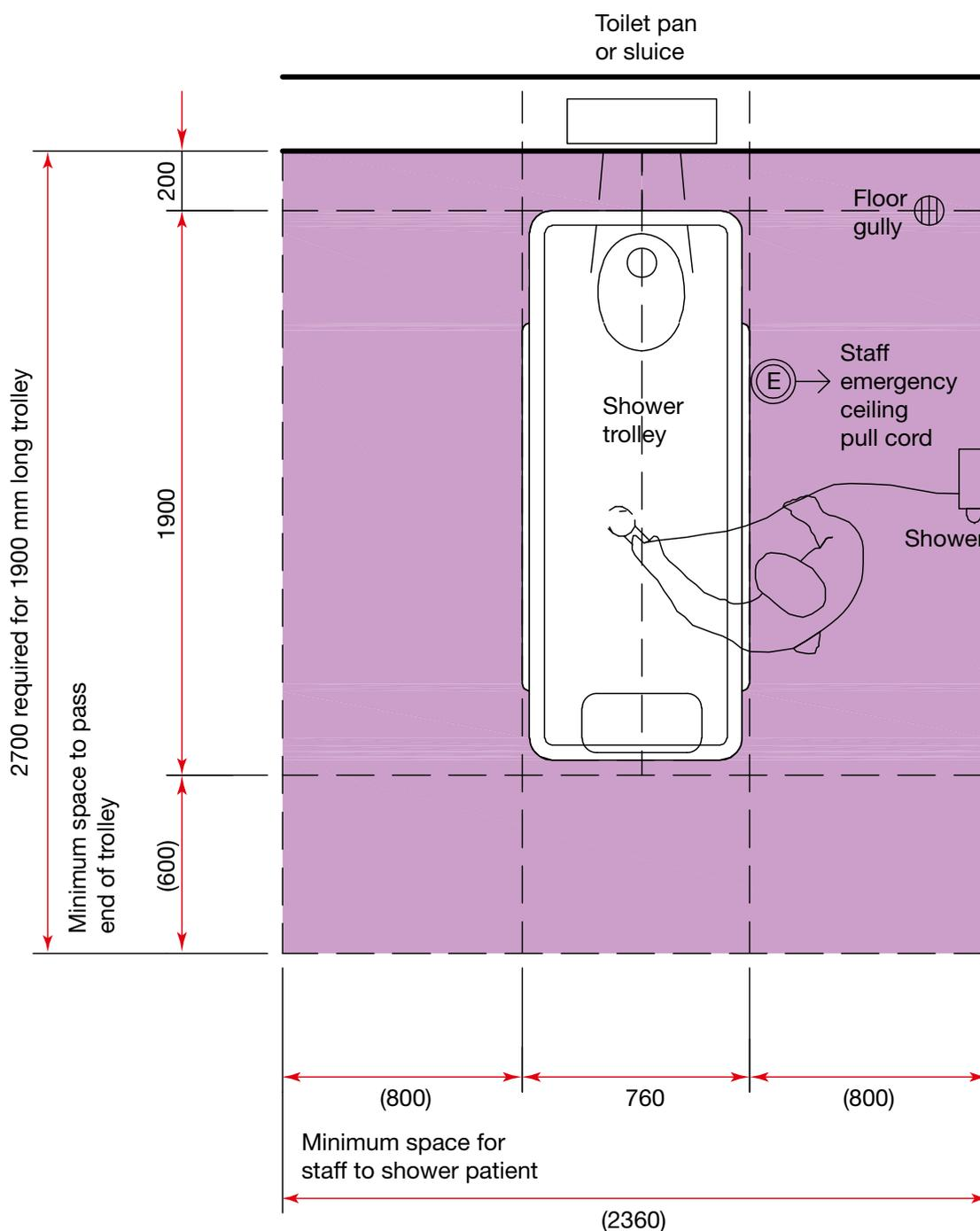

Figure 67 Space requirements for trolley access shower

Toilet: assisted

4.104 This ergonomic drawing (see Figure 68) shows the space requirements for an assisted toilet.

4.105 The clear space on either side of the toilet for mobile hoist transfer is greater than that recommended in BS 8300 (Figure 55).

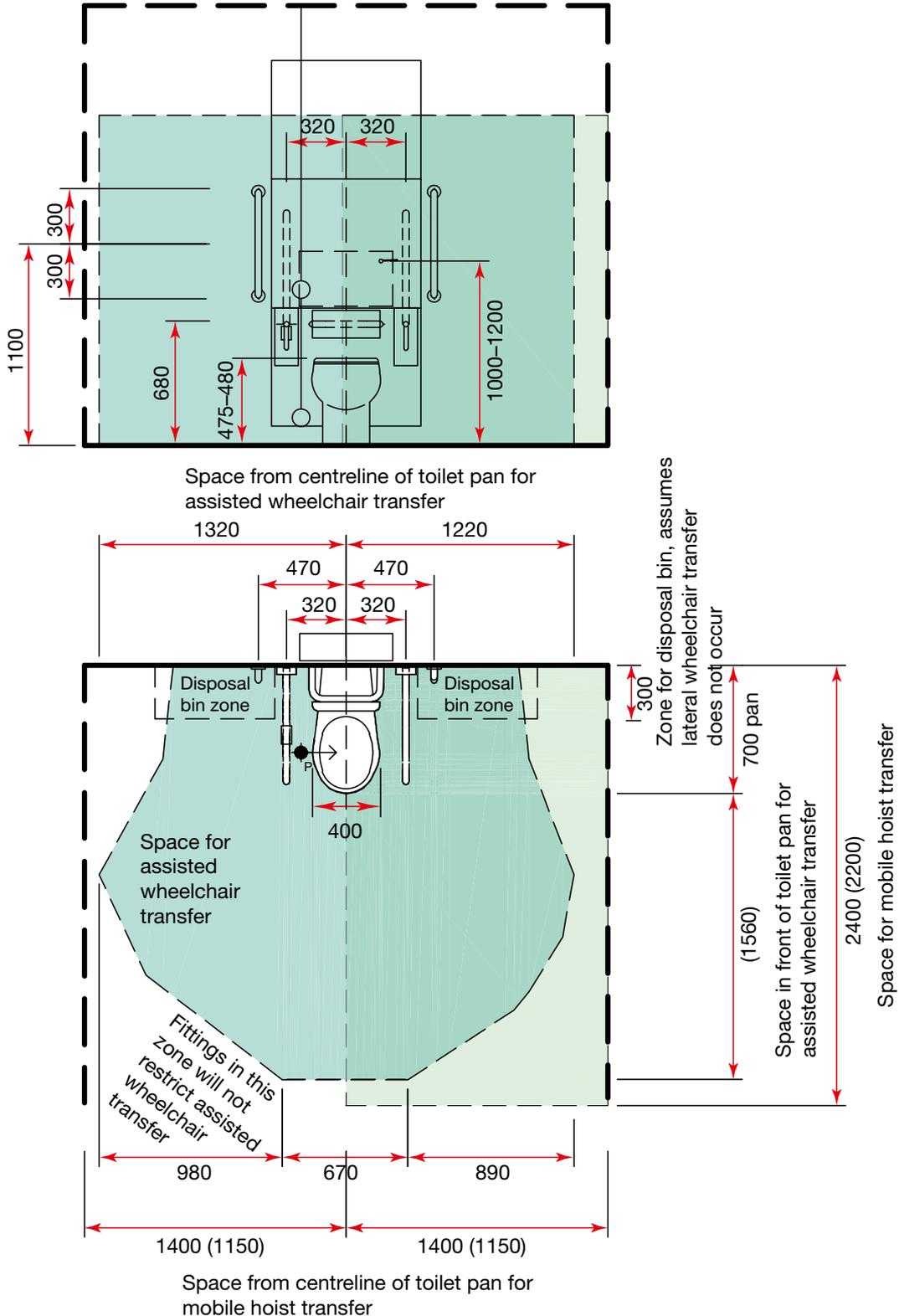

Figure 68 Space requirements for assisted toilet

Wash-hand basin: wheelchair

4.106 Wash-hand basins may be used for personal washing activities.

4.107 This ergonomic drawing (see Figure 69) shows the space requirements for a wheelchair accessible wash-hand basin. It is also suitable for seated use.

4.108 It includes a shaver socket adjacent to the wash-hand basin and a light above the mirror; these are optional. The inclusion of a shaver socket depends on project requirements. The need for a local light depends on the overall lighting scheme within the room.

4.109 The drawing also shows two short lever taps. Alternatively a single mixer tap or sensor-operated taps may be used. See Health Building Note 00-10 Part C – ‘Sanitary assemblies’ for details.

4.110 Wheelchair-accessible wash-hand basins should have a size and profile that maximises access and reduces obstructions. They should:

- be as shallow as possible, that is, tapered from the rim to a depth not exceeding 250 mm at the outlet, which in turn should be positioned as near the supporting wall as possible;
- preferably project 500 mm in order to provide adequate leg room underneath the basin.

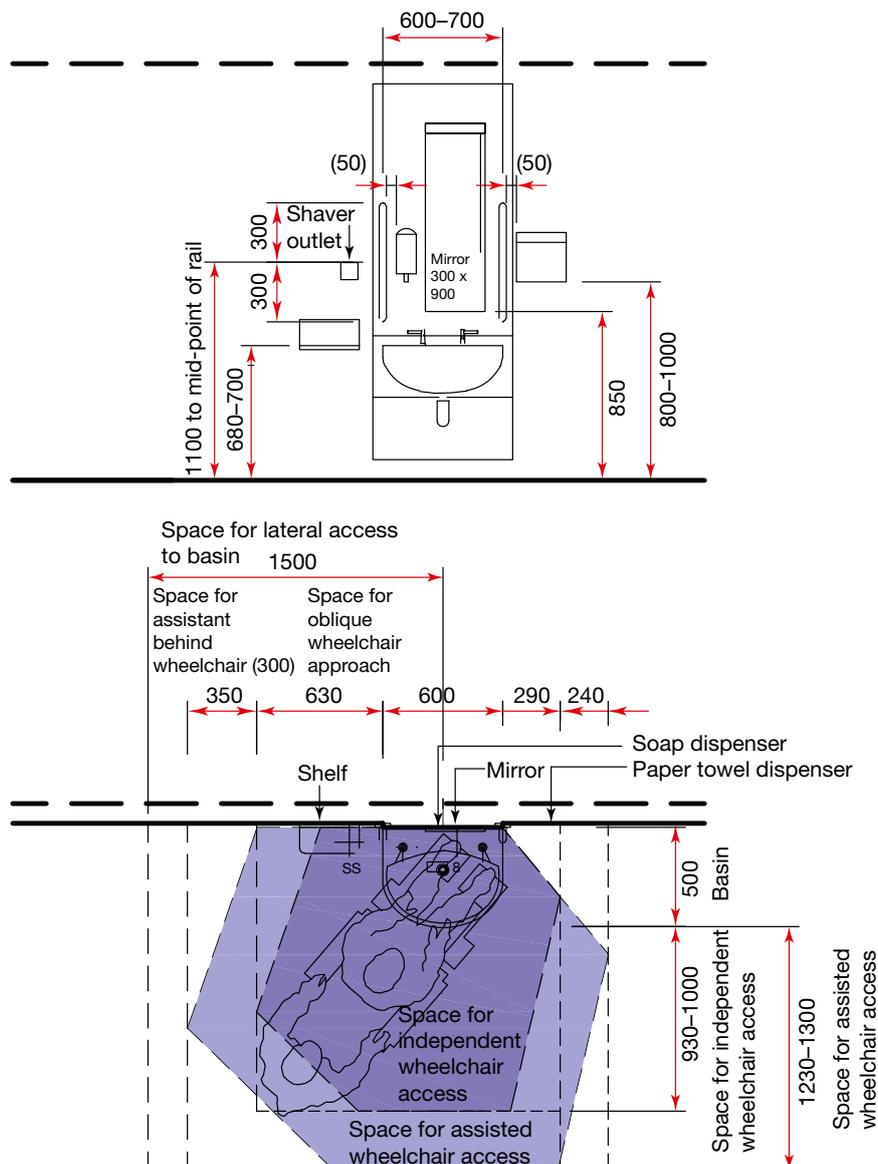

Figure 69 Space requirements for wheelchair accessible wash-hand basin

Full-length mirror: standing or seated users

4.111 This ergonomic drawing (see Figure 70) shows the space requirements for a full-length mirror for standing or seated users.

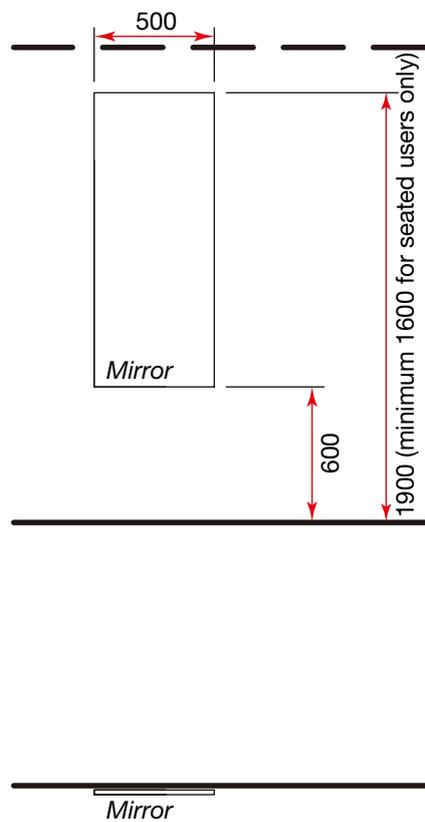

Figure 70 Space requirements for full-length mirror for standing or seated users

Shower room: trolley access: private use

Room description and layout

4.112 The following assisted activities take place in trolley access shower rooms:

- wheelchair and sanitary chair access to the toilet and wash-hand basin;
- mobile hoist access to transfer a patient to the toilet or to attend to a patient collapsed on the floor;
- patient transfer from a wheelchair to the toilet (supervised only);
- use of the toilet;

- personal washing (whilst the patient is seated);
- shower trolley access to the shower;
- showering (whilst the patient is lying on the shower trolley).

4.113 Trolley access showers are suitable for patients who are reliant on assisted movement. The room layout provided (see Figure 71) utilises the minimum clear space requirement to the side of the toilet for mobile hoist transfer (that is, 1150 mm from the centreline of the toilet to the nearest obstruction), on the basin side of the toilet only.

4.114 The drainpipe at the foot of the shower trolley should be positioned over the toilet to deal with incontinence episodes during showering.

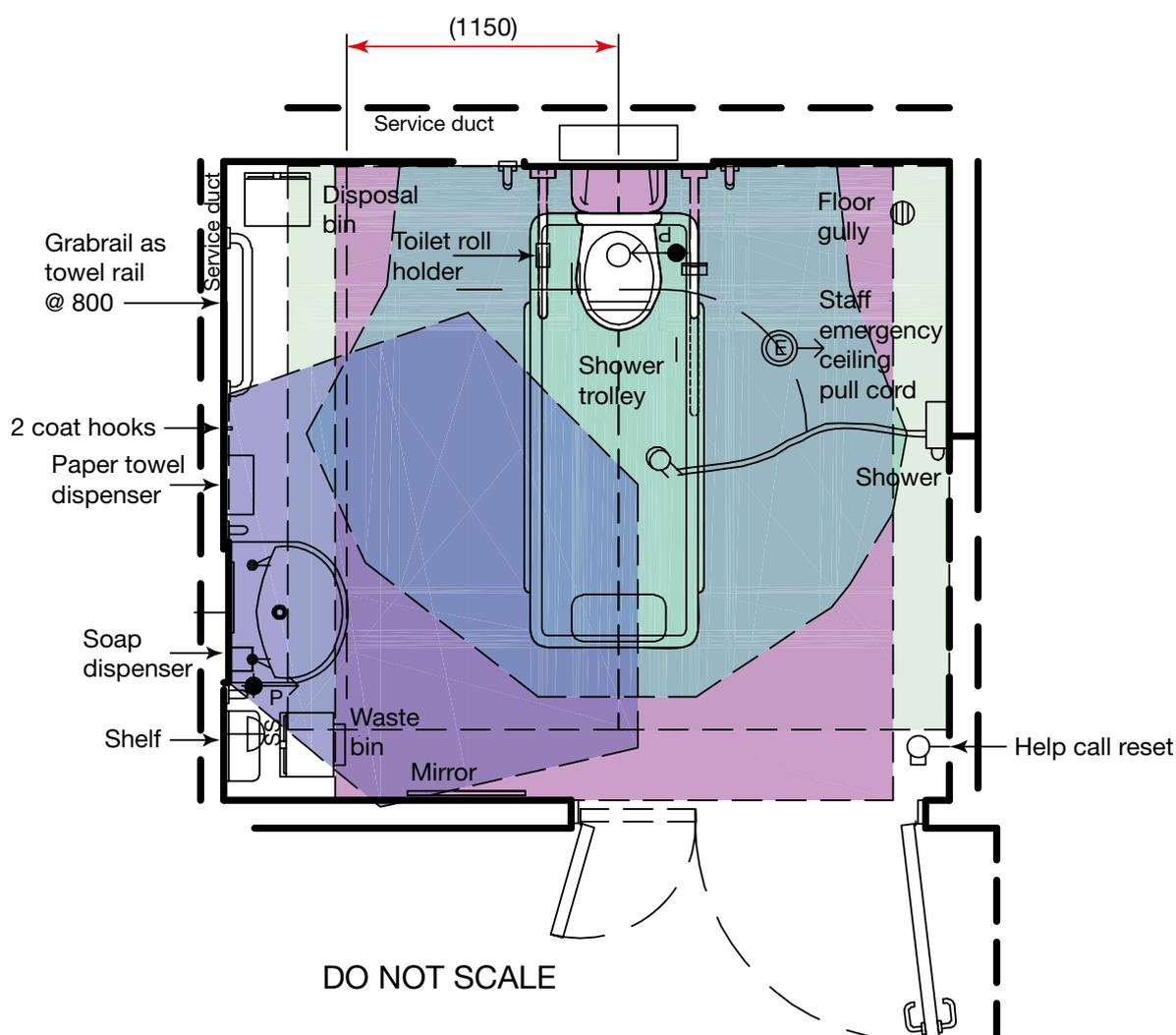

Figure 71 Space requirements for shower room: trolley access: private use, minimum clear space requirement for mobile hoist transfer

Ergonomic drawings

Trolley access shower

4.115 This ergonomic drawing (see Figure 72) shows the space requirements for a trolley access shower.

4.116 A minimum of 800 mm clear space at the head of the trolley is required if staff need to stand in this position during showering.

4.117 The shower panel should have a pressure and temperature control thermostatic mixer. The shower hose should be long enough to allow staff to shower the full length of the patient from either side with a trigger handle. This shower fitting is not specifically covered in Health Building Note 00-10 Part C – ‘Sanitary assemblies’.

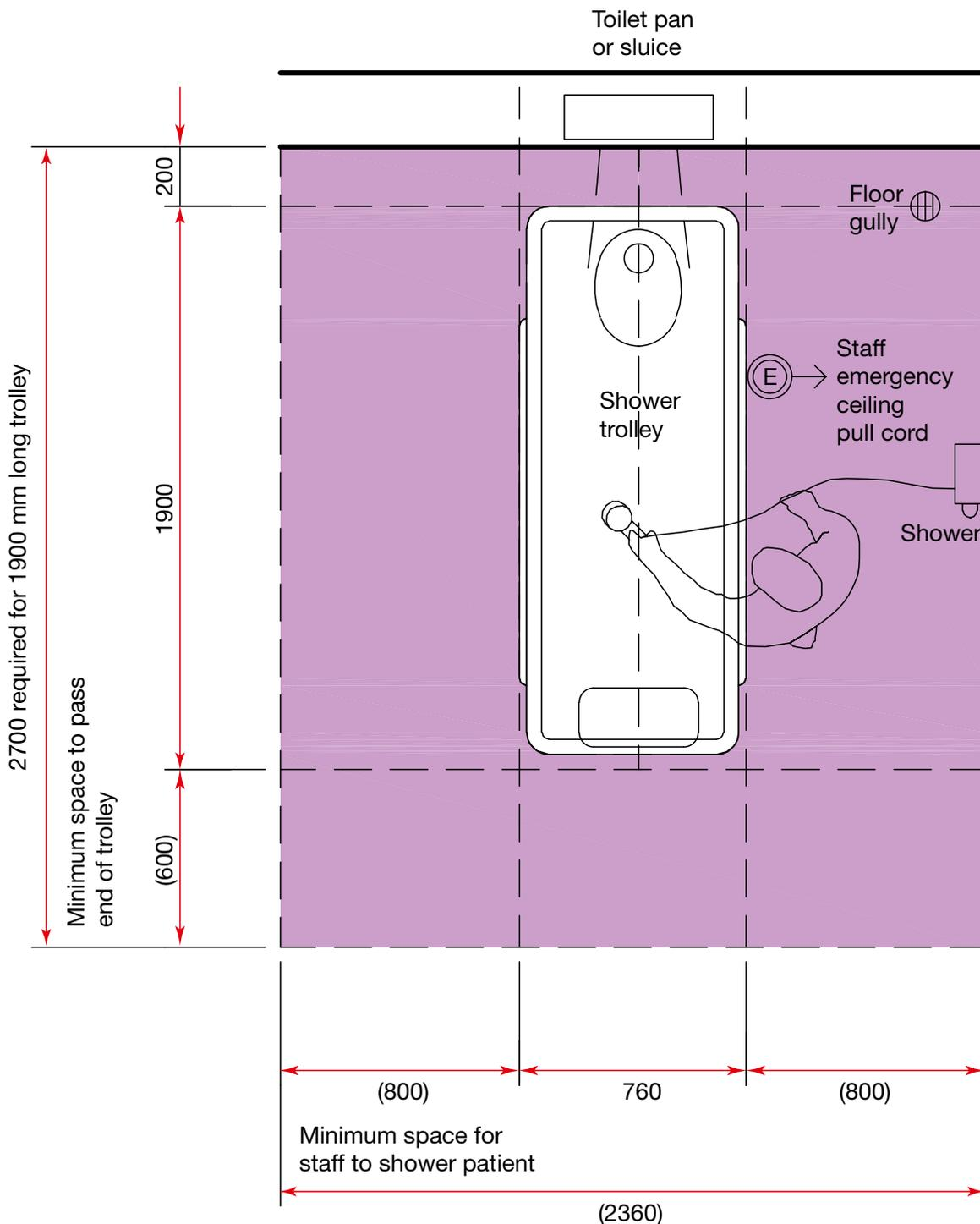

Figure 72 Space requirements for trolley access shower

Toilet: assisted

4.118 This ergonomic drawing (see Figure 73) shows the space requirements for an assisted toilet.

4.119 The clear space on either side of the toilet for mobile hoist transfer is greater than that recommended in BS 8300 (Figure 55).

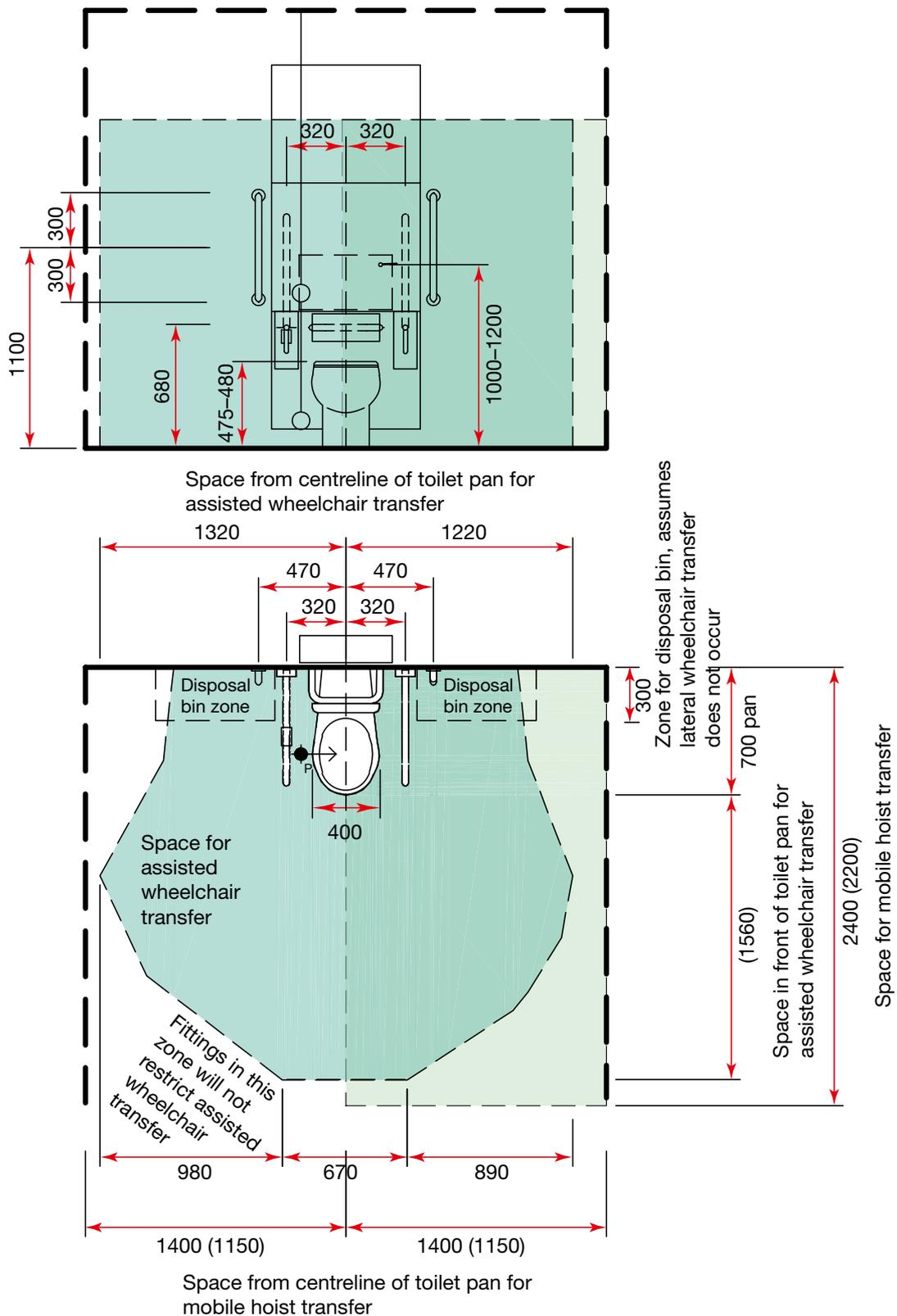

Figure 73 Space requirements for assisted toilet

Wash-hand basin: wheelchair

4.120 Wash-hand basins may be used for personal washing activities.

4.121 This ergonomic drawing (see Figure 74) shows the space requirements for a wheelchair accessible wash-hand basin. It is also suitable for seated use.

4.122 It includes a shaver socket adjacent to the wash-hand basin and a light above the mirror; these are optional. The inclusion of a shaver socket depends on project requirements. The need for a local light depends on the overall lighting scheme within the room.

4.123 The drawing also shows two short lever taps. Alternatively a single mixer tap or sensor-operated taps may be used. See Health Building Note 00-10 Part C – ‘Sanitary assemblies’ for details.

4.124 Wheelchair-accessible wash-hand basins should have a size and profile that maximises access and reduces obstructions. They should:

- be as shallow as possible, that is, tapered from the rim to a depth not exceeding 250 mm at the outlet, which in turn should be positioned as near the supporting wall as possible;
- preferably project 500 mm in order to provide adequate leg room underneath the basin.

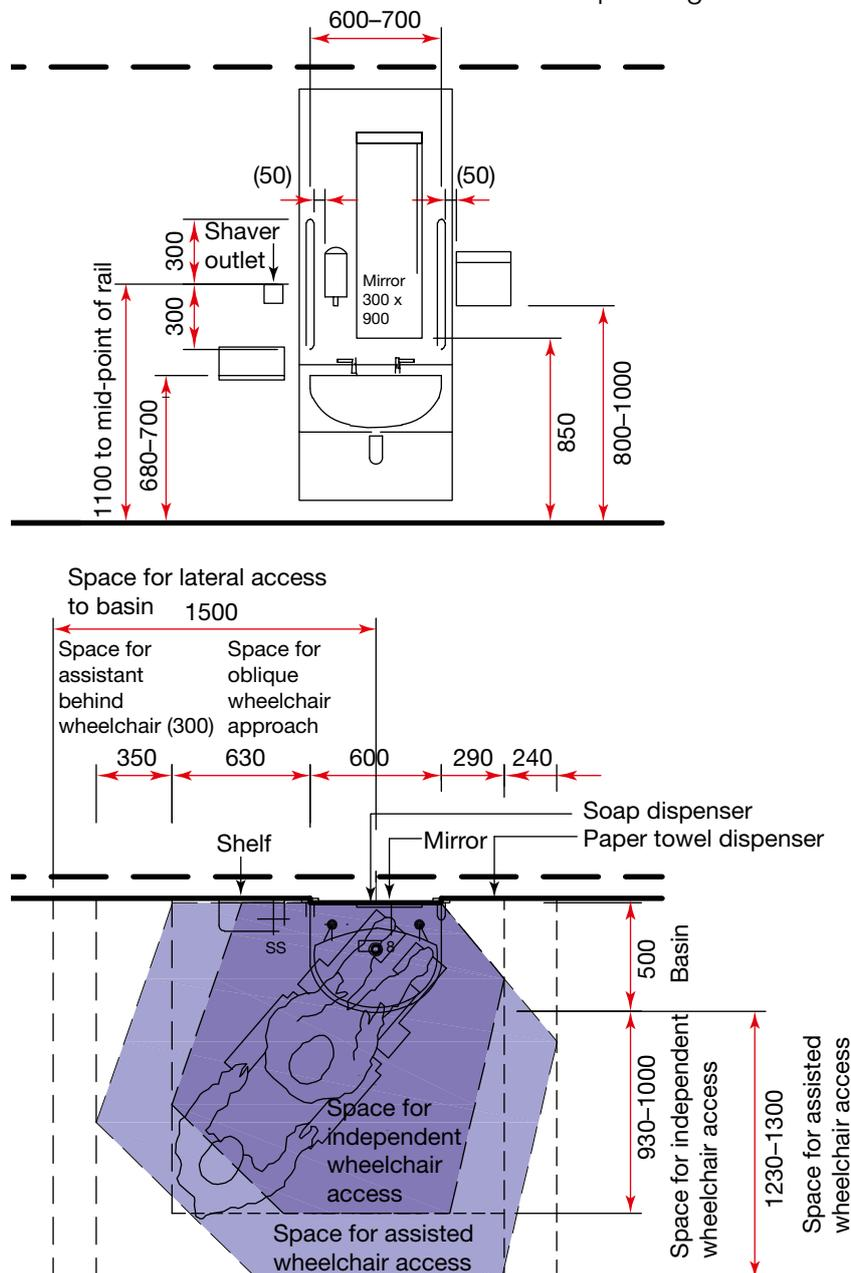

Figure 74 Space requirements for wheelchair accessible wash-hand basin

Full-length mirror: standing or seated users

4.125 This ergonomic drawing (see Figure 75) shows the space requirements for a full-length mirror for standing or seated users.

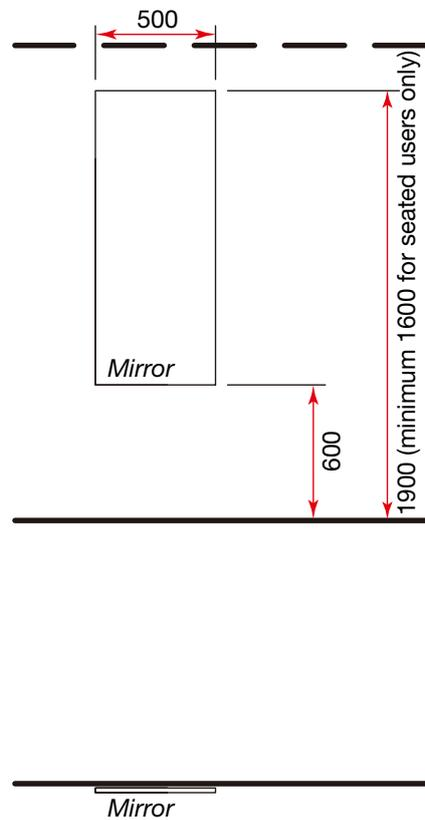

Figure 75 Space requirements for full-length mirror for standing or seated users

5 WCs

WC: ambulant

Room description and layout

5.1 The following activities take place in ambulant WCs:

- use of the toilet;
- disposal of sanitary towels (optional);
- hand-rinsing.

5.2 Ambulant WCs are only suitable for fully ambulant users and should not be used in patient spaces.

5.3 Toilet seats should be provided in ambulant WCs.

5.4 The room layout provided (see Figure 76) includes a 300 mm deep hand-rinse basin. Where a larger hand-rinse basin (up to 350 mm deep) is used, minimum internal room dimensions may need to increase to maintain the required activity space.

5.5 A space allocation for luggage has been included to allow belongings/bags to be comfortably taken into the WC for security.

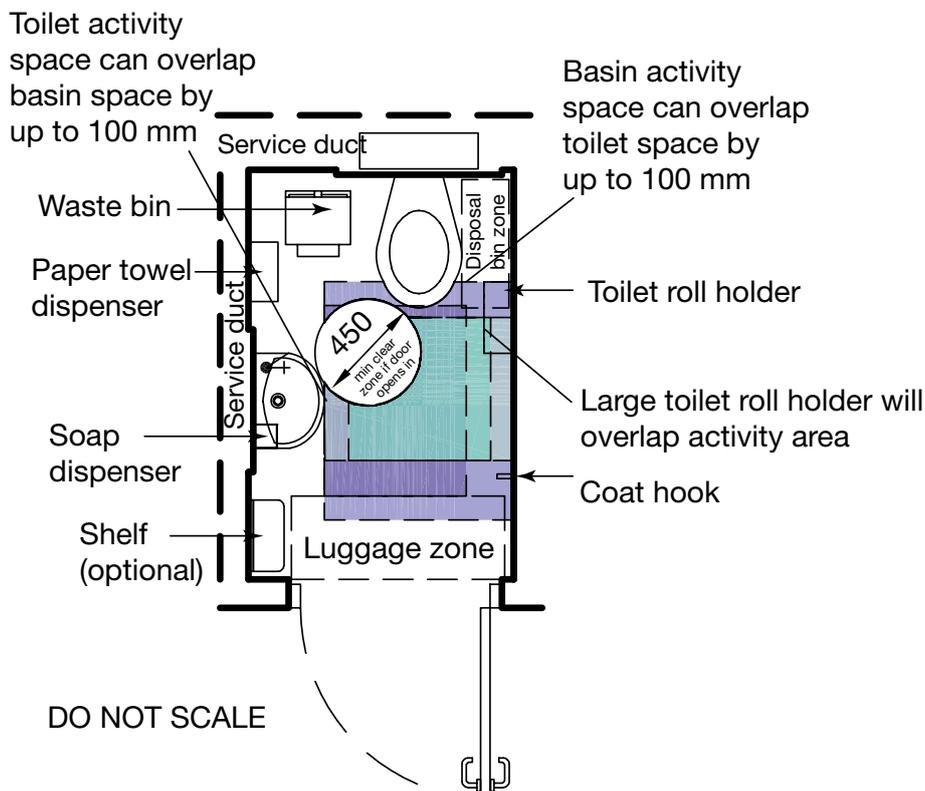

Figure 76 Space requirements for WC: ambulant, 300 mm deep hand-rinse basin

Ergonomic drawings

Toilet: ambulant

5.7 A large toilet roll holder would overlap the activity area.

5.6 This ergonomic drawing (see Figure 77) shows the space requirements for an ambulant toilet.

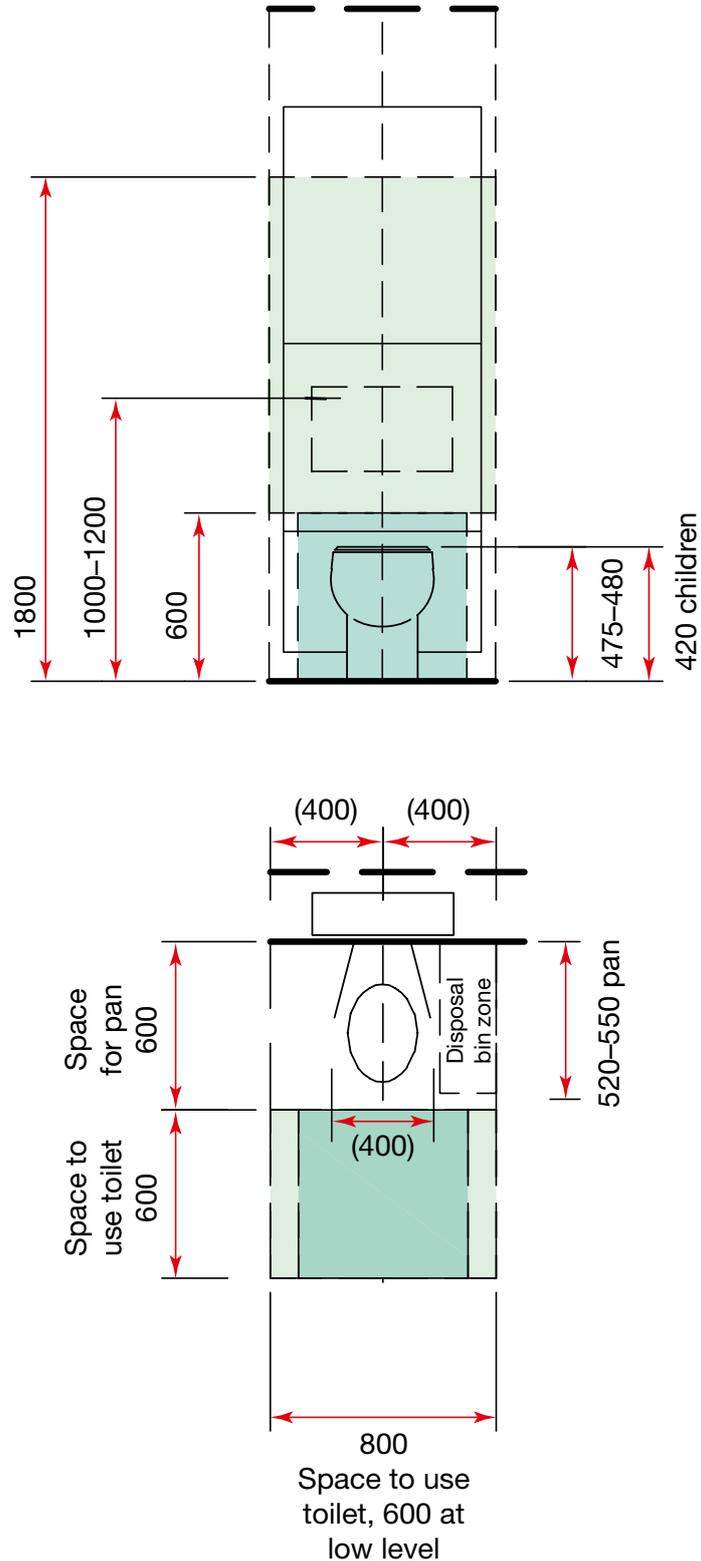

Figure 77 Space requirements for ambulant toilet

Hand-rinse basin: ambulant

5.8 This ergonomic drawing (see Figure 78) shows the space requirements for a 300 mm deep hand-rinse basin. It is suitable for ambulant and semi-ambulant use.

5.9 Hand-rinse basins are generally only suitable for rinsing hands under running water. They should have a single mixer tap.

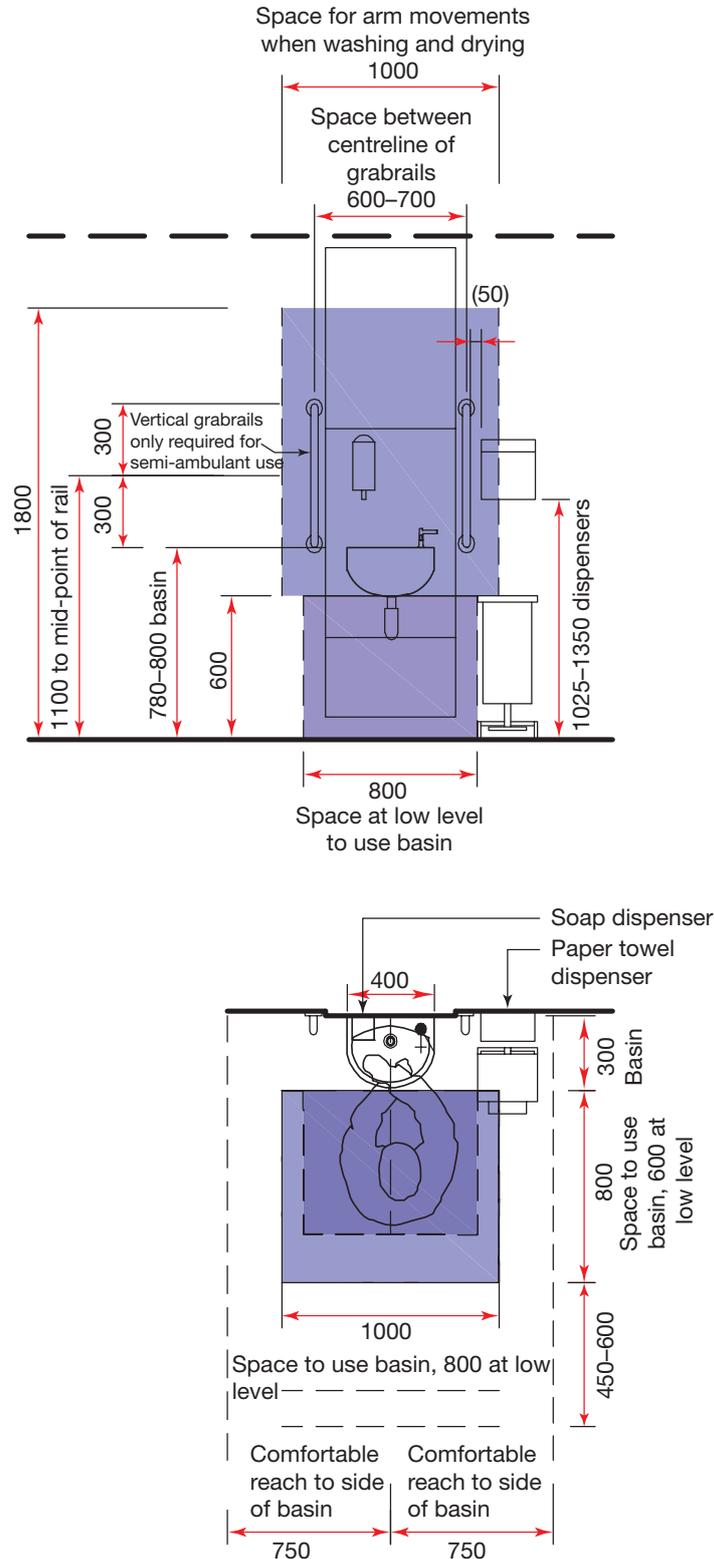

Figure 78 Space requirements for 300 mm deep hand-rinse basin suitable for ambulant and semi-ambulant use

WC: assisted

Room description and layout

5.10 The following assisted activities take place in assisted WCs:

- wheelchair and sanitary chair access to the toilet and wash-hand basin;
- mobile hoist access to transfer a patient to the toilet or to attend to a patient collapsed on the floor;
- patient transfer from a wheelchair to the toilet (supervised only);
- use of the toilet;
- personal washing (whilst the patient is seated).

5.11 Peninsular (also known as island) toilets are required to allow space on either side of the toilet pan for assistance. With the absence of an adjacent wall, this layout may not provide the same feeling of security as a corner toilet layout and is not considered suitable for independent wheelchair users.

5.12 An assisted WC should contain a wheelchair wash-hand basin. A hand-rinse basin, accessible from the toilet, is not acceptable since this would conflict with the space requirements for assistance.

5.13 Assisted WCs should only be used where appropriate assistance is available.

5.14 Mobile hoist access will be required if a patient collapses on the floor even if it is not used for transferring patients to the toilet.

5.15 The room layout provided (see Figure 79) utilises the minimum clear space requirement to the side of the toilet for mobile hoist transfer (that is, 1150 mm from the centreline of the toilet to the nearest obstruction), on the basin side of the toilet only.

5.16 To enable this space to be suitable for ambulant and semi-ambulant use as well as assisted use, an adjustable-height wash-hand basin may be provided in place of the wheelchair wash-hand basin.

5.17 The disposal bin is shown located away from the toilet to maximise the space for transfer and because it is assumed that the assistant will transfer waste to the bin or move the bin closer to the toilet when required.

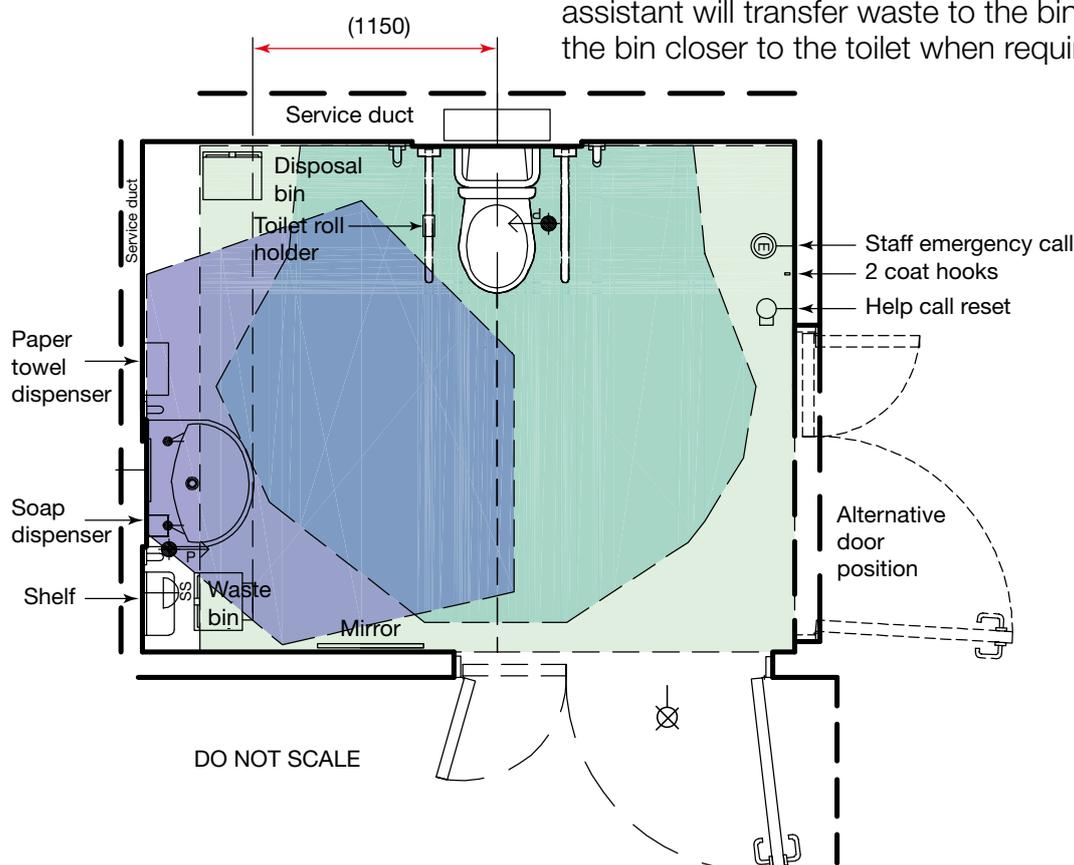

Figure 79 Space requirements for WC: assisted with minimum clear space requirement for mobile hoist transfer

Ergonomic drawings

Toilet: assisted

5.18 This ergonomic drawing (see Figure 80) shows the space requirements for an assisted toilet.

5.19 The clear space on either side of the toilet for mobile hoist transfer is greater than that recommended in BS 8300 (Figure 55).

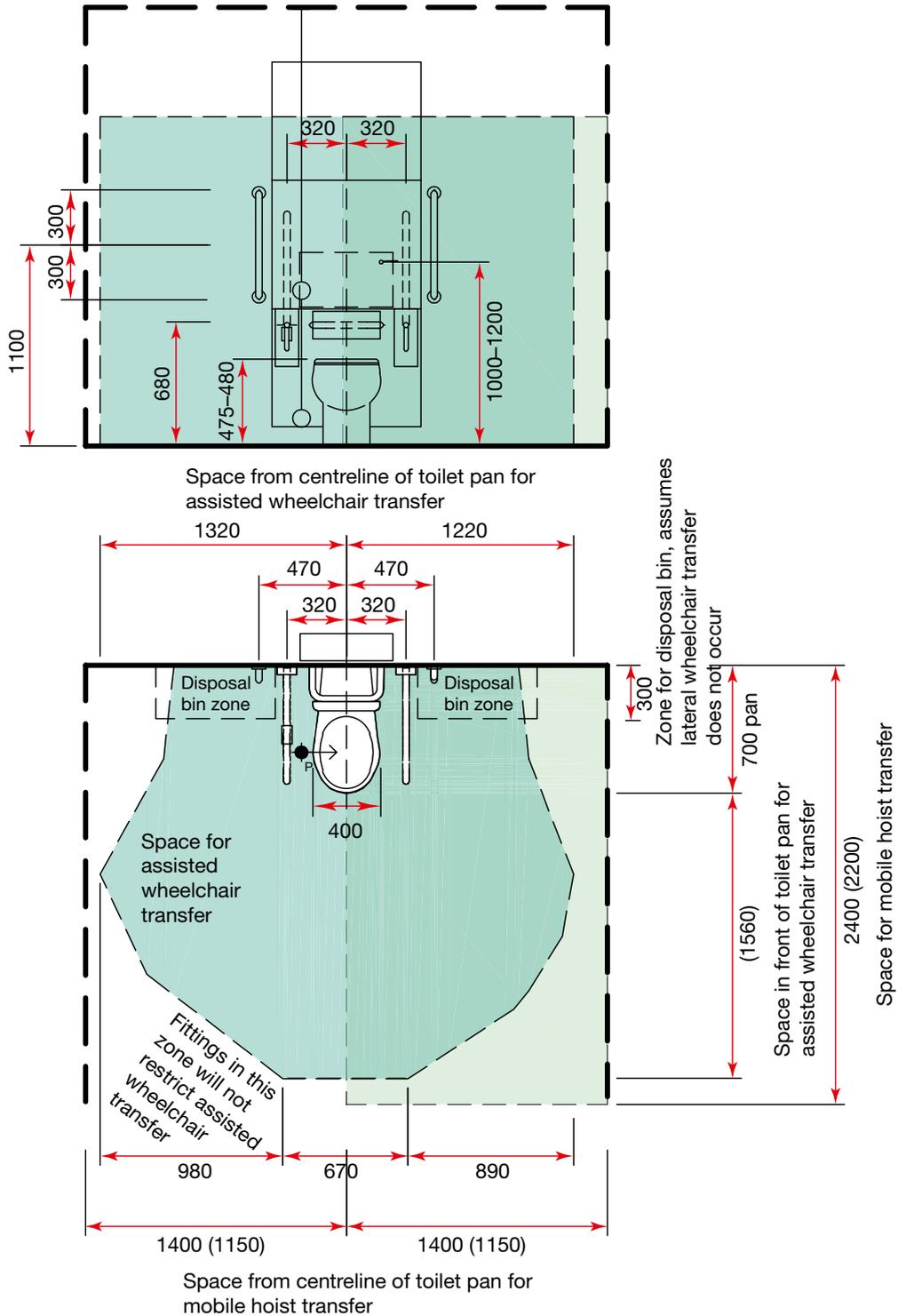

Figure 80 Space requirements for assisted toilet

Wash-hand basin: wheelchair

5.20 Wash-hand basins may be used for personal washing activities.

5.21 This ergonomic drawing (see Figure 81) shows the space requirements for a wheelchair accessible wash-hand basin. It is also suitable for seated use.

5.22 It includes a shaver socket adjacent to the wash-hand basin and a light above the mirror; these are optional. The inclusion of a shaver socket depends on project requirements. The need for a local light depends on the overall lighting scheme within the room.

5.23 The drawing also shows two short lever taps. Alternatively a single mixer tap or sensor-operated taps may be used. See Health Building Note 00-10 Part C – ‘Sanitary assemblies’ for details.

5.24 Wheelchair-accessible wash-hand basins should have a size and profile that maximises access and reduces obstructions. They should:

- be as shallow as possible, that is, tapered from the rim to a depth not exceeding 250 mm at the outlet, which in turn should be positioned as near the supporting wall as possible;
- preferably project 500 mm in order to provide adequate leg room underneath the basin.

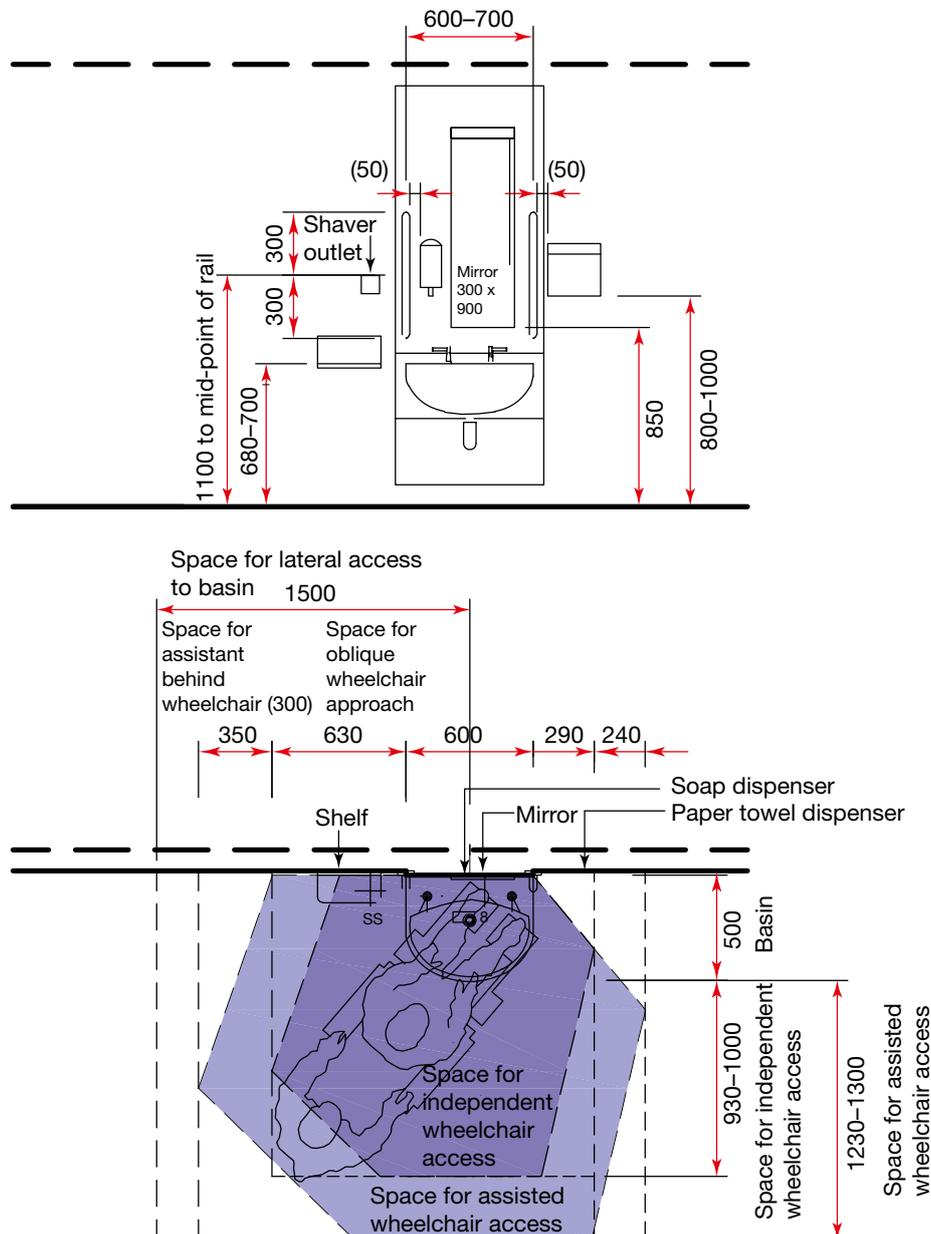

Figure 81 Space requirements for wheelchair accessible wash-hand basin

Full-length mirror: standing or seated users

5.25 This ergonomic drawing (see Figure 82) shows the space requirements for a full-length mirror for standing or seated users.

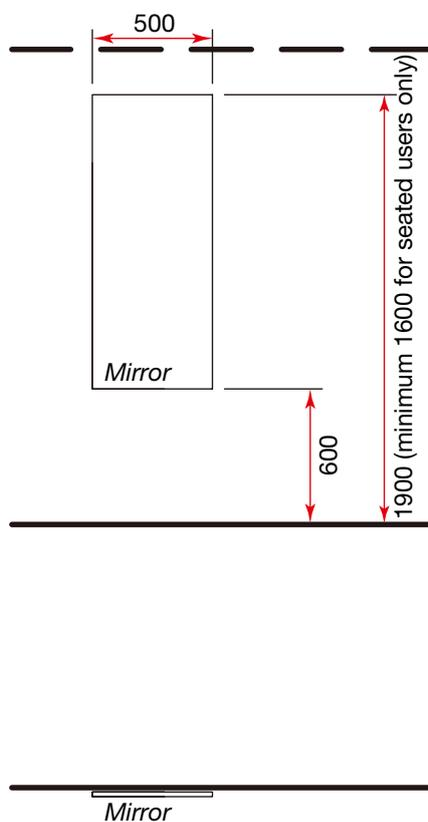

Figure 82 Space requirements for full-length mirror standing or seated users

WC: independent wheelchair/semi-ambulant

Room description and layout

5.26 The following activities take place in independent wheelchair/semi-ambulant WCs:

- wheelchair access to the toilet and hand-rinse basin;
- independent transfer from a wheelchair to the toilet;
- use of the toilet;
- disposal of sanitary towels and wipes;
- emptying of urine bottles/colostomy bags;
- hand-rinsing (whilst in a wheelchair facing the hand-rinse basin or seated on the toilet);
- personal washing (for semi-ambulant users).

5.27 An independent wheelchair/semi-ambulant WC should be provided where it is the only WC within an area. See BS 8300 (paragraph 12.6.1) and Approved Document M (paragraph 5.10e).

5.28 Wheelchair users need to be able to rinse and dry their hands from a seated position on the toilet before transferring back onto their wheelchairs (to avoid the possibility of staining clothes or wheelchairs and to assist with infection control). This is only possible with a corner toilet with an adjacent hand-rinse basin.

5.29 To facilitate good access to the hand-rinse basin from the toilet, the mixer tap should be positioned on the side of the hand-rinse basin nearest to the toilet. Left or right-handed tap hole hand-rinse basins may be required depending on the layout of facilities.

5.30 The flush system should be located on the open (transfer) side of the toilet to ensure it is easily reachable by a wheelchair user facing the toilet.

5.31 The layout (see Figure 83) allows for right-hand independent wheelchair transfer to the toilet.

5.32 It includes a separate ambulant wash-hand basin for semi-ambulant users.

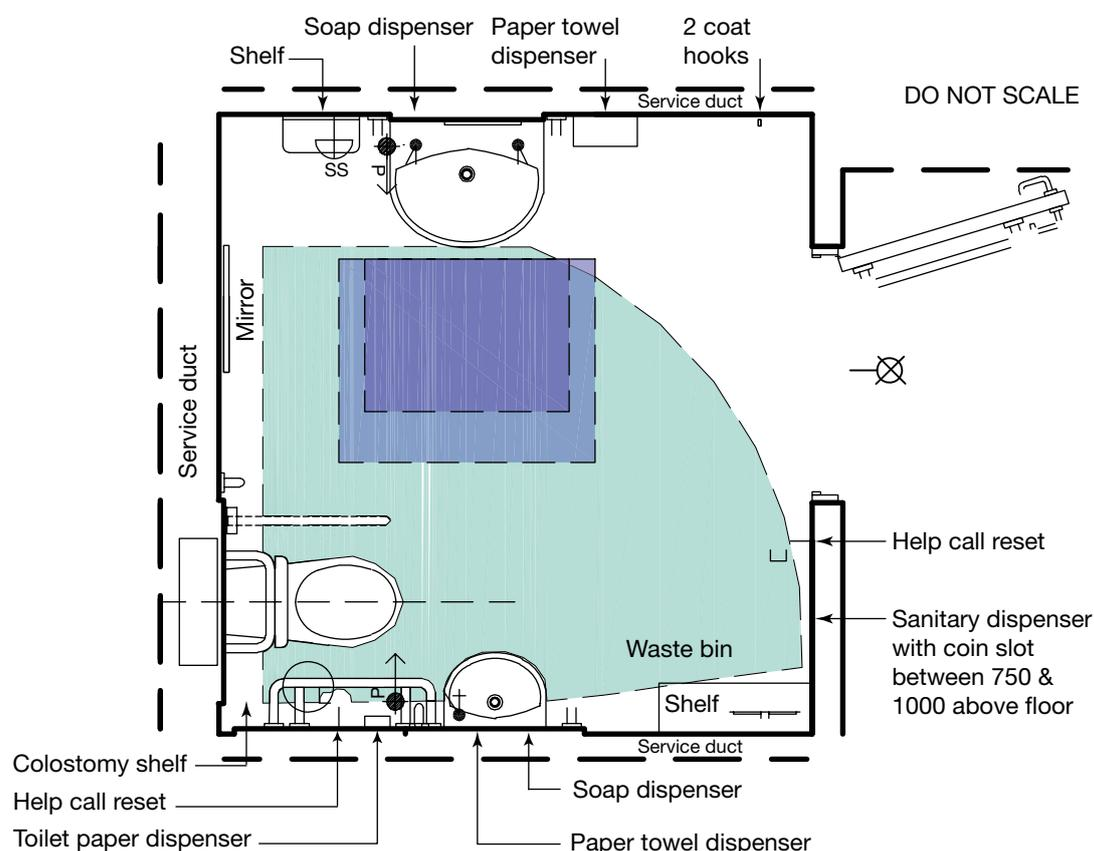

Figure 83 Space requirements for WC: independent wheelchair/semi-ambulant use with right-hand independent wheelchair transfer

Ergonomic drawings

Toilet and adjacent hand-rinse basin: independent wheelchair

5.33 This ergonomic drawing (see Figure 84) shows the space requirements for an independent wheelchair toilet and adjacent hand-rinse basin.

5.34 The recommended clear space in front and to the open side of the toilet (for independent wheelchair transfer) is greater than the recommendations in Approved Document M and BS 8300.

5.35 Approved Document M and BS 8300 recommend a minimum clear distance of 1000 mm to the open side of the centreline of the toilet for independent wheelchair transfer. Robert Feeney Associates (RFA) research for BS 8300 indicates that this will allow just over 60% of wheelchair users to comfortably transfer onto the toilet. The same research indicates that a clear space of 1400 mm accommodates 90% of wheelchair users and this is, therefore, recommended.

5.36 Approved Document M and BS 8300 recommend a 750 mm long toilet pan for independent wheelchair transfer. However, RFA research indicated that a 700 mm long toilet pan allows independent wheelchair transfer. For maximum space efficiency a 700 mm pan is recommended.

5.37 As a consequence of the reduction in pan length, the hand-rinse basin is located closer to the corner of the room than the position given in Approved Document M and BS 8300, to allow hand-rinsing from a seated position on the toilet.

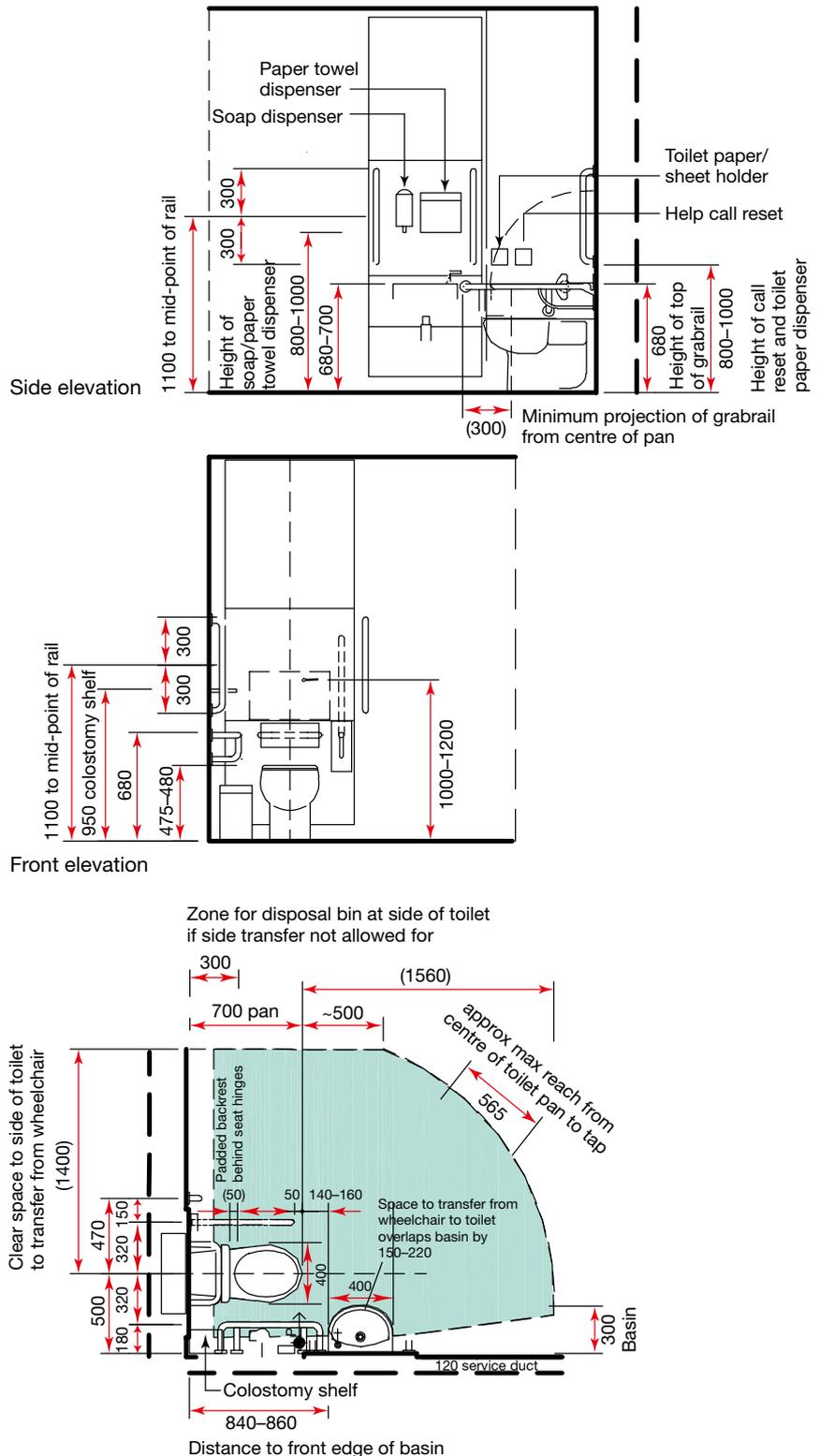

Figure 84 Space requirements for an independent wheelchair toilet and adjacent hand-rinse basin

*Toilet and adjacent hand-rinse basin:
independent wheelchair: grabrail options*

5.38 These ergonomic drawings (see Figure 85) show the fixing position of grabrails for an independent wheelchair toilet and adjacent hand-rinse basin.

5.39 Grabrails should be provided symmetrically on either side of the toilet at 320 mm from the centreline of the toilet pan. This conflicts with the recommendations in Approved Document M and BS 8300.

5.40 Approved Document M (paragraph 5.10j) states: “where the horizontal support rail on the wall adjacent to the toilet is set with the minimum spacing from the wall, an additional dropdown rail should be provided on the wall side at a distance of 320 mm from the centreline of the toilet.”

Note

Where the maximum spacing defined in Approved Document M, 85 mm, is used, this positions the grabrail approximately 390 mm from the centreline of the toilet, which is not symmetrical with the hinged grabrail on the other side.

5.41 BS 8300 (paragraph 12.6.3.5 b) states: “A fixed horizontal rail should be located on the side wall with a 50 mm to 60 mm clearance between the rail and the wall.” This places the rail approximately 420 mm from the centreline of the toilet, which is not symmetrical with the hinged grabrail on the other side.

5.42 The ergonomic drawings provided illustrate two options for the provision of grabrails. The room layouts on this website are based on option one.

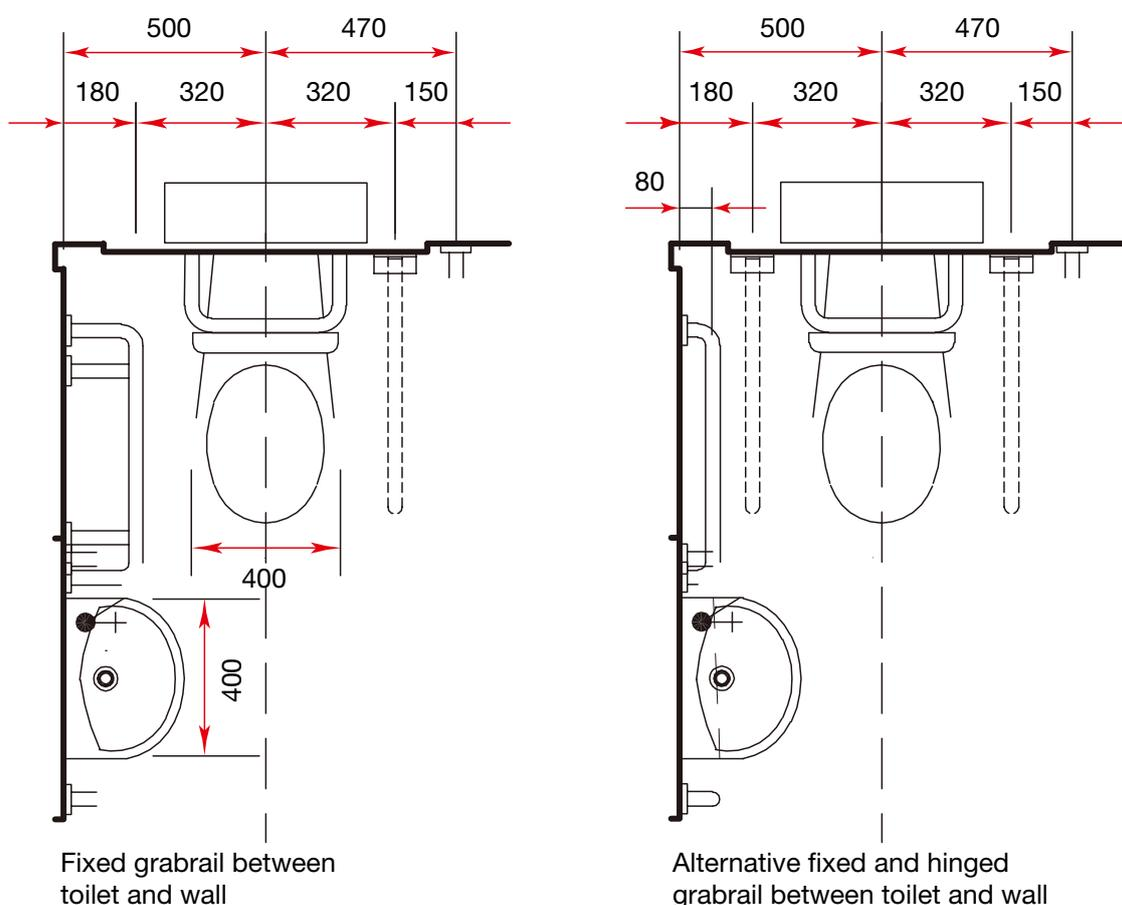

Figure 85 Space requirements showing fixing position of grabrails for independent wheelchair toilet and adjacent hand-rinse basin

Wash-hand basin: ambulant

5.43 Wash-hand basins may be used for personal washing activities.

5.44 This ergonomic drawing (see Figure 86) shows the space requirements for ambulant/semi-ambulant use of a 400 mm deep x 500 mm wide wash-hand basin.

5.45 It includes a shaver socket adjacent to the wash-hand basin and a light above the mirror;

these are optional. The inclusion of a shaver socket depends on project requirements. The need for a local light depends on the overall lighting scheme within the room.

5.46 The drawing also shows two short lever taps. Alternatively a single mixer tap or sensor-operated taps may be used. See Health Building Note 00-10 Part C – ‘Sanitary assemblies’ for details.

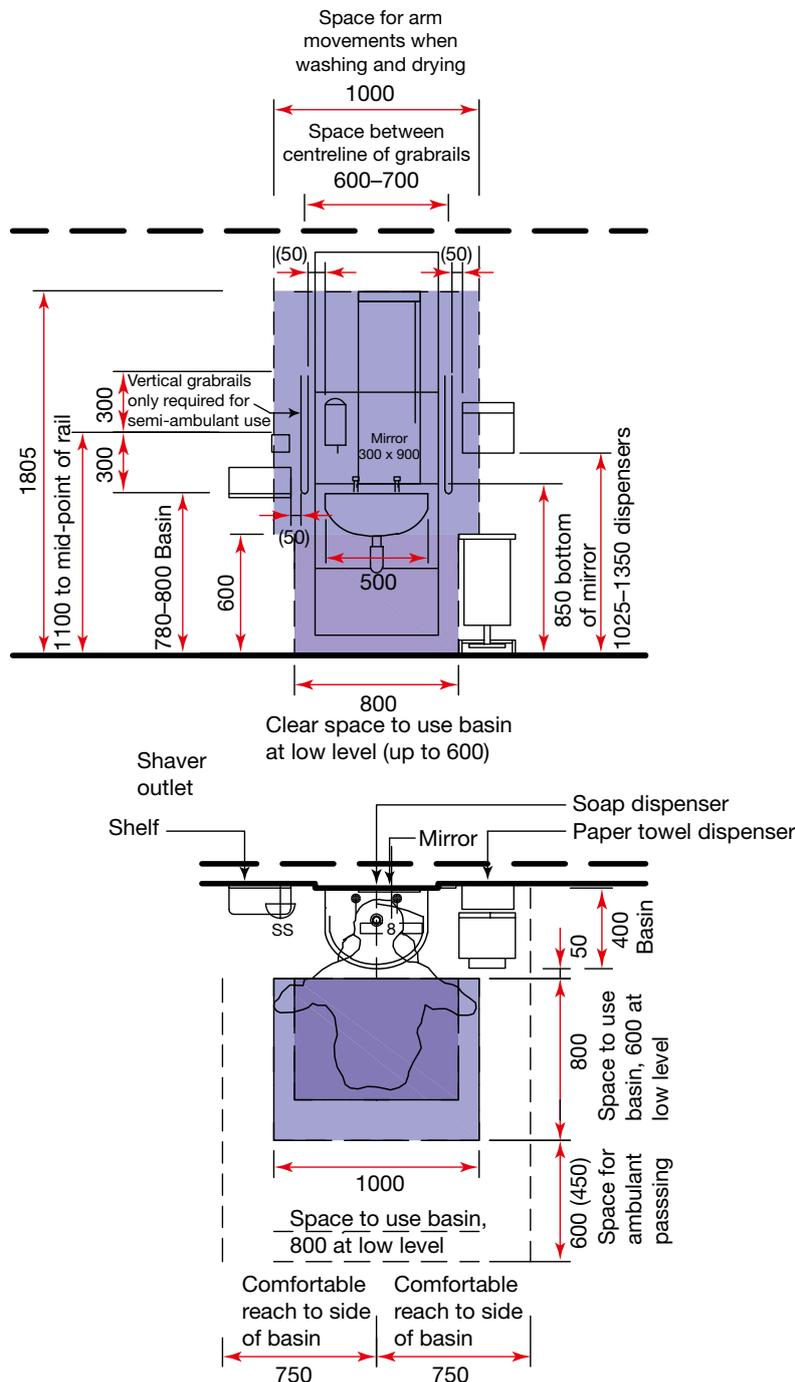

Figure 86 Space requirements for ambulant/semi-ambulant use of 400 mm deep x 500 mm wide wash-hand basin

Full-length mirror: standing or seated users

5.47 This ergonomic drawing (see Figure 87) shows the space requirements for a full-length mirror for standing or seated users.

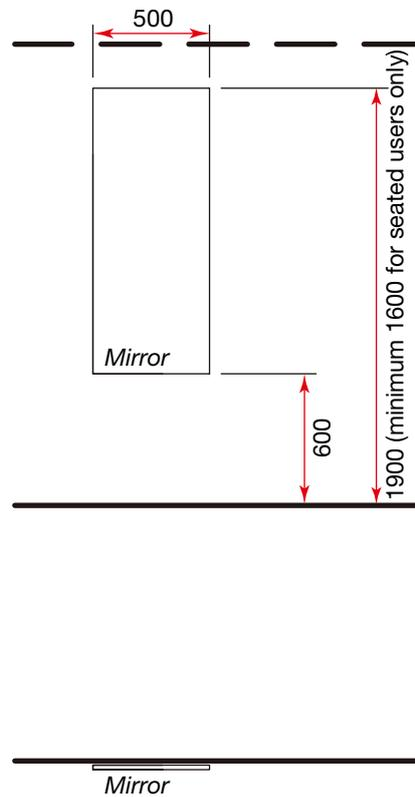

Figure 87 Space requirements for full-length mirror for standing or seated users

WC: Semi-ambulant

Room description and layout

5.48 The following activities take place in a semi-ambulant WC (see Figure 88):

- use of the toilet;
- disposal of sanitary towels (optional);
- hand-rinsing.

5.49 Semi-ambulant WCs are also suitable for fully ambulant users.

5.50 The semi-ambulant WC layout includes a hand-rinse basin.

5.51 A space allocation for luggage has been included to provide room for belongings/bags to be comfortably taken into the WC for security.

5.52 The minimum clear width is 900 mm. While 1000 mm is preferred for movement with walking aids, 900 mm is considered acceptable since there is additional space above and below the basin for movement.

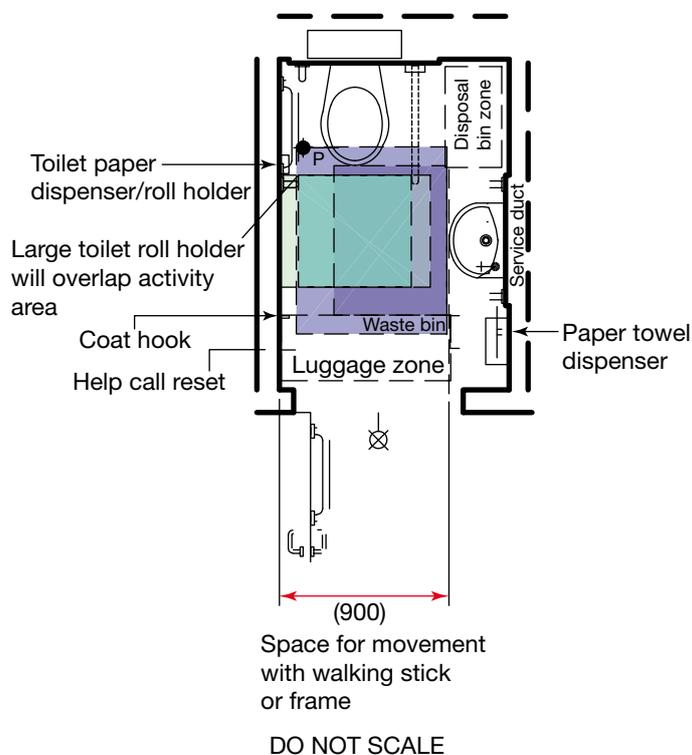

Figure 88 WC: semi-ambulant

Ergonomic drawings

5.53 The ergonomic drawings (see Figure 89) show the space requirements for a semi-ambulant WC and hand-rinse basin.

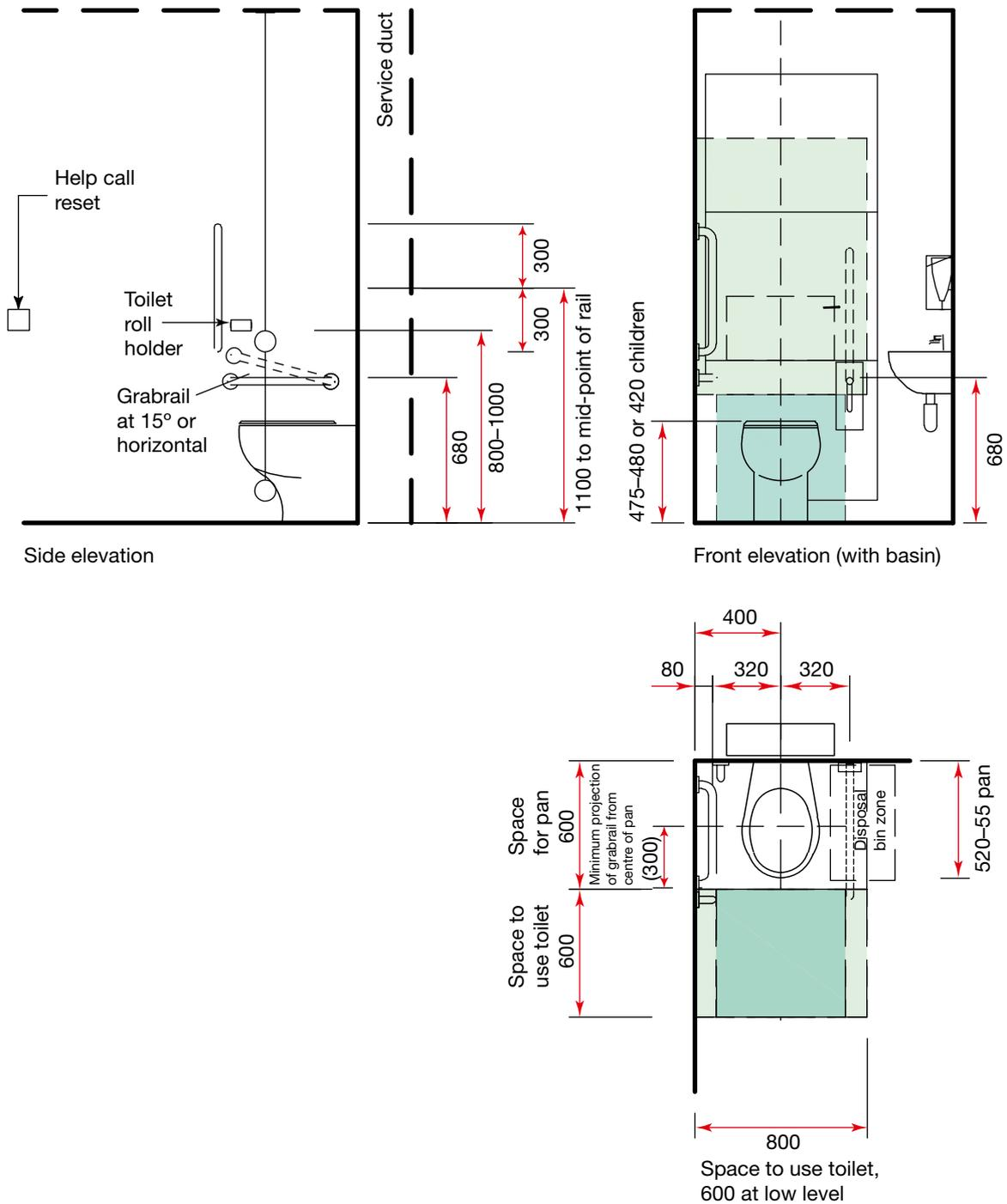

Figure 89 Space requirements for semi-ambulant toilet and adjacent hand-rinse basin

WC: independent wheelchair

Room description and layout

5.54 The following activities take place in independent wheelchair WCs:

- wheelchair access to the toilet and hand-rinse basin;
- independent transfer from a wheelchair to the toilet;
- use of the toilet;
- disposal of sanitary towels and wipes;
- emptying of urine bottles/colostomy bags;
- hand-rinsing (whilst in a wheelchair facing the hand-rinse basin or seated on the toilet).

5.55 Users need to be able to rinse and dry their hands from a seated position on the toilet before transferring back onto their wheelchairs (to avoid the possibility of staining clothes or wheelchairs and to assist with infection control). This is only possible with a corner toilet with an adjacent hand-rinse basin.

5.56 To facilitate good access to the hand-rinse basin from the toilet, the mixer tap should be positioned on the side of the hand-rinse basin nearest to the toilet. Left or right-handed tap hole hand-rinse basins may be required depending on the layout of facilities.

5.57 The flush system should be located on the open (transfer) side of the toilet to ensure it is easily reachable by a wheelchair user facing the toilet.

5.58 Independent wheelchair WCs are also suitable for semi-ambulant users with, or without, “hands-off assistance” who may wish to sit down to wash their hands.

5.59 The room layout provided is larger than the equivalent space in Approved Document M and BS 8300.

5.60 Approved Document M and BS 8300 recommend a minimum room length of 2200 mm for independent wheelchair WCs. Robert Feeney Associates research for BS 8300 indicates that a clear space of 1600 (1560) mm in front of the toilet is required for transfer. This equates to a minimum room length of 2300 (2260) mm (using a 700 mm long toilet pan) and is recommended.

5.61 The room layout (see Figure 90) allows right-hand transfer to the toilet. Where more than one independent wheelchair WC is provided within a facility, left-hand and right-hand options should be available. See Approved Document M, paragraph 5.10d.

5.62 The disposal bin adjacent to the toilet should be a maximum of 200 mm wide and 480 mm high and capable of being operated with one hand.

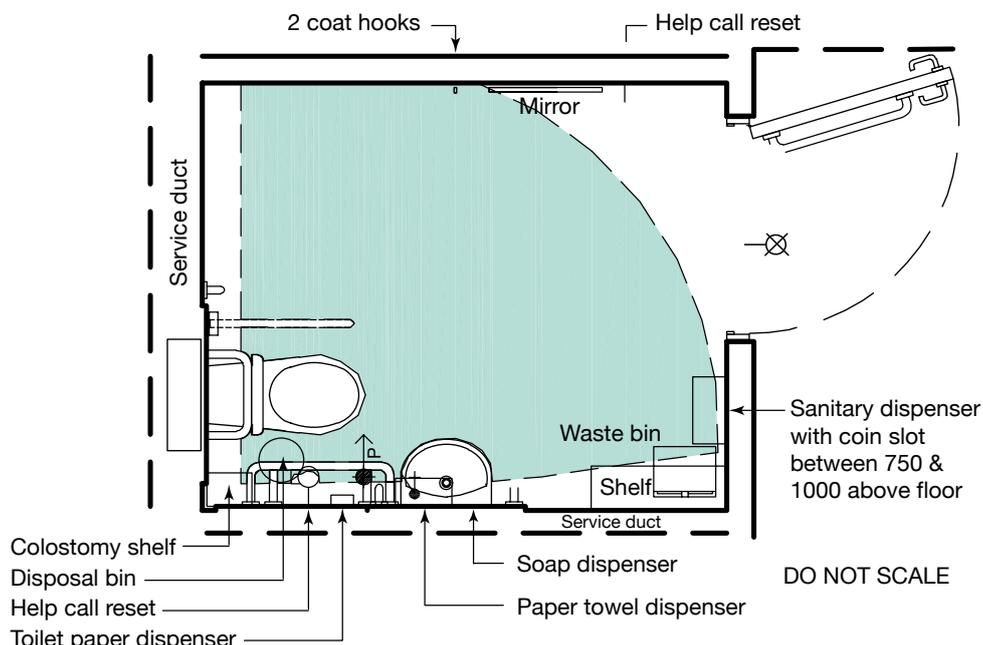

Figure 90 Space requirement for WC: independent wheelchair with right-hand transfer to toilet

Ergonomic drawings

Toilet and adjacent hand-rinse basin: independent wheelchair

5.63 This ergonomic drawing (see Figure 91) shows the space requirements for an independent wheelchair toilet and adjacent hand-rinse basin.

5.64 The recommended clear space in front and to the open side of the toilet (for independent wheelchair transfer) is greater than the recommendations in Approved Document M and BS 8300.

5.65 Approved Document M and BS 8300 recommend a minimum clear distance of 1000 mm to the open side of the centreline of the toilet for independent wheelchair transfer. Robert Feeney Associates (RFA) research for BS 8300 indicates that this will allow just over 60% of wheelchair users to comfortably transfer onto the toilet. The same research indicates that a clear space of 1400 mm accommodates 90% of wheelchair users and this is, therefore, recommended.

5.66 Approved Document M and BS 8300 recommend a 700 mm long toilet pan for independent wheelchair transfer. However, RFA research indicated that a 700 mm long toilet pan allows independent wheelchair transfer. For maximum space efficiency a 700 mm pan is recommended.

5.67 As a consequence of the reduction in pan length, the hand-rinse basin is located closer to the corner of the room than the position given in Approved Document M and BS 8300, to allow hand-rinsing from a seated position on the toilet.

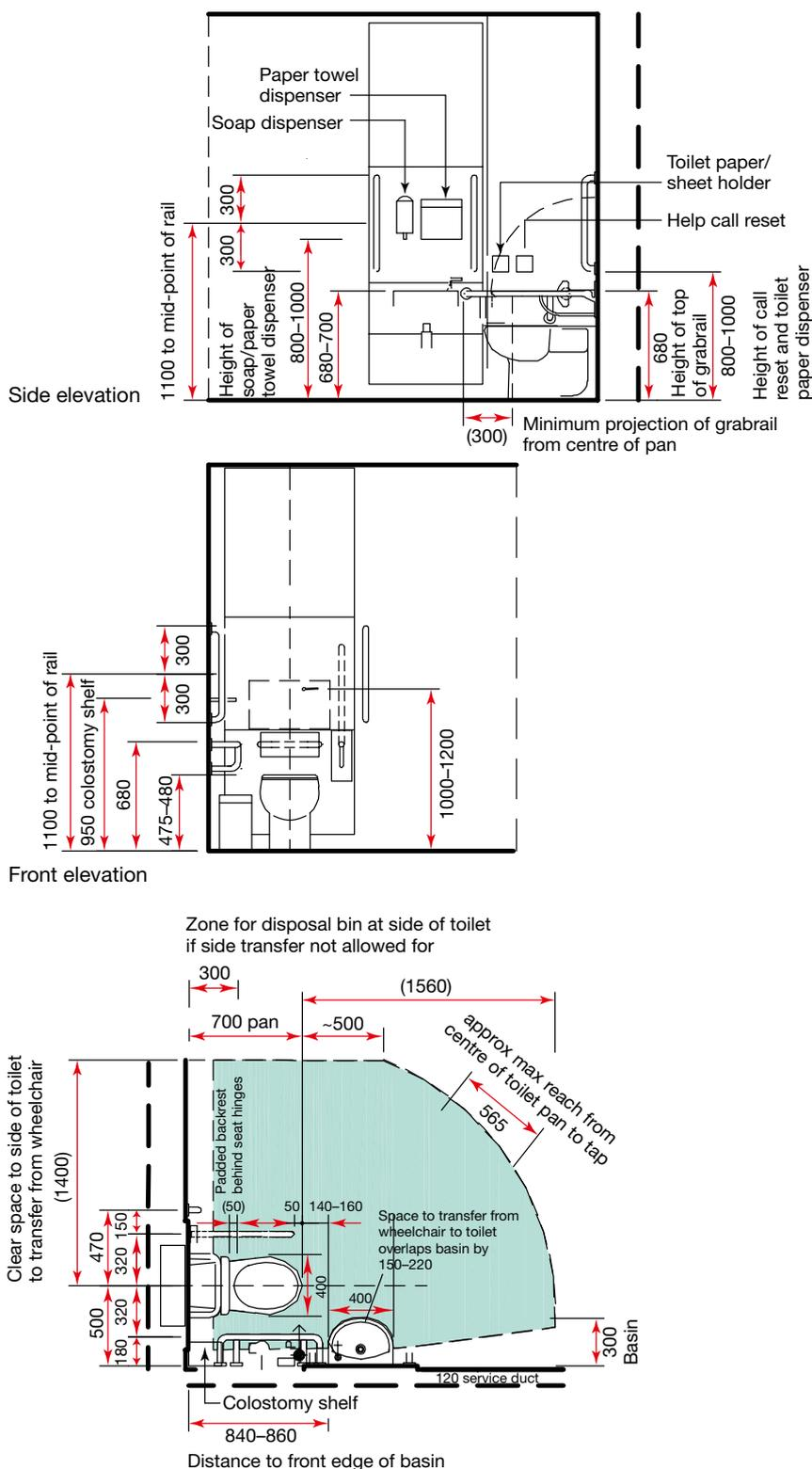

Figure 91 Space requirements for independent wheelchair toilet and adjacent hand-rinse basin

*Toilet and adjacent hand-rinse basin:
independent wheelchair: grabrail options*

5.68 These ergonomic drawings (see Figure 92) show the fixing position of grabrails for an independent wheelchair toilet and adjacent hand-rinse basin.

5.69 Grabrails should be provided symmetrically on either side of the toilet at 320 mm from the centreline of the toilet pan. This conflicts with the recommendations in Approved Document M and BS 8300.

5.70 Approved Document M (paragraph 5.10j) states: “where the horizontal support rail on the wall adjacent to the toilet is set with the minimum spacing from the wall, an additional dropdown rail should be provided on the wall side at a distance of 320 mm from the centreline of the toilet.”

Note
Where the maximum spacing defined in Approved Document M, 85 mm, is used, this positions the grabrail approximately 390 mm from the centreline of the toilet, which is not symmetrical with the hinged grabrail on the other side.

5.71 BS 8300 (paragraph 12.6.3.5 b) states: “A fixed horizontal rail should be located on the side wall with a 50 mm to 60 mm clearance between the rail and the wall.” This places the rail approximately 420 mm from the centreline of the toilet, which is not symmetrical with the hinged grabrail on the other side.

5.72 The ergonomic drawings provided illustrate two options for the provision of grabrails. The room layouts on this website are based on option one.

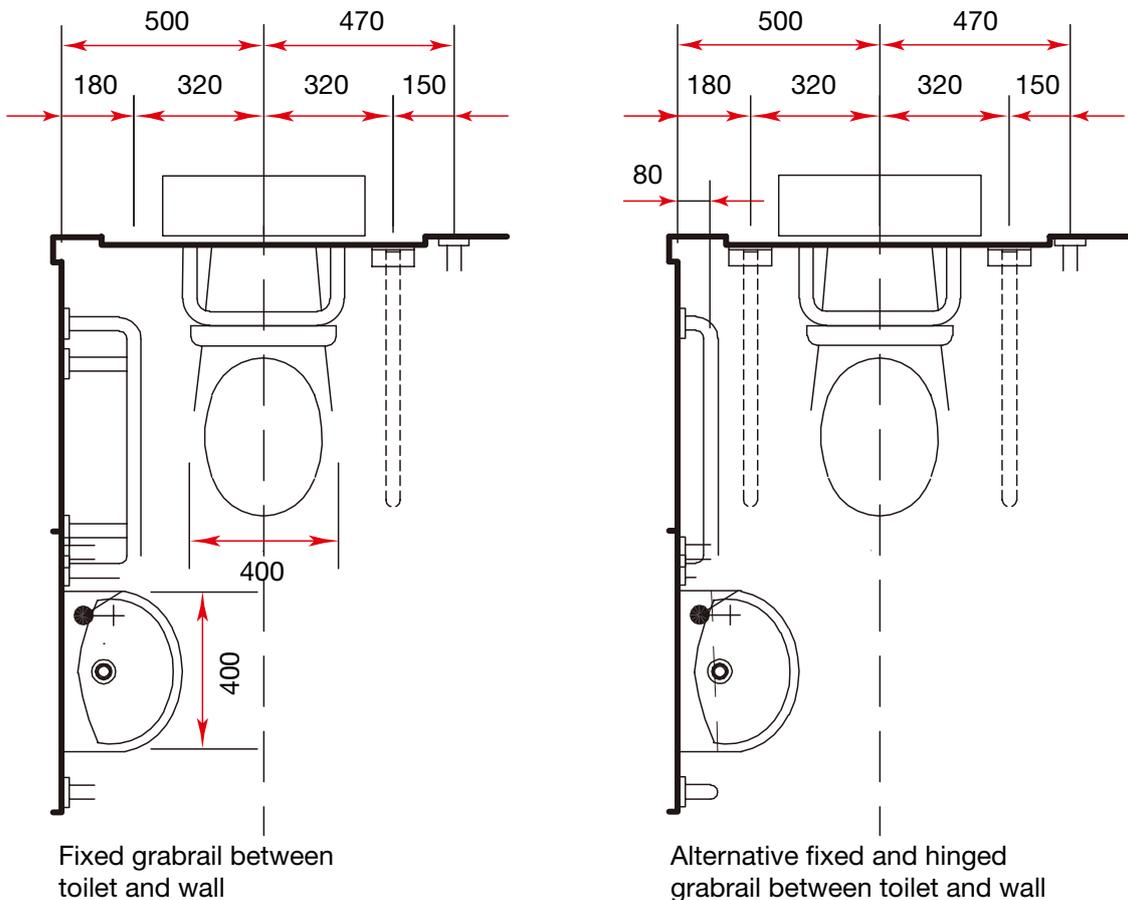

Figure 92 Space requirements showing fixing position of grabrails for independent wheelchair toilet and adjacent hand-rinse basin

Full-length mirror: standing or seated users

5.73 This ergonomic drawing (see Figure 93) shows the space requirements for a full-length mirror for standing or seated users.

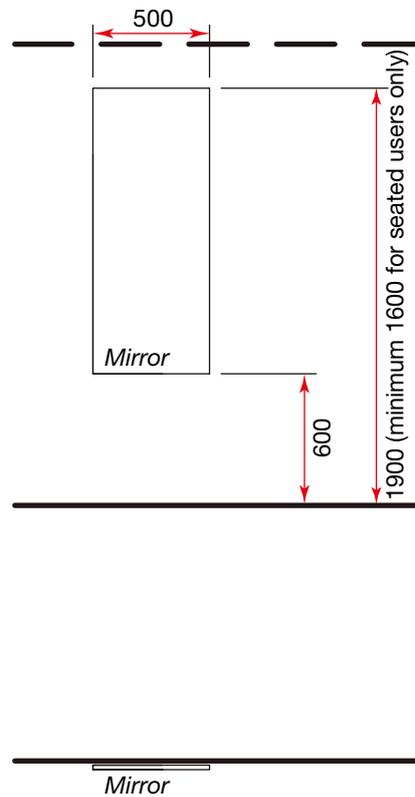

Figure 93 Space requirements for full-length mirror for standing or seated users

WC: ‘Changing Places’¹

Room description and layout

5.74 The following activities take place in a ‘Changing Places’ toilet:

- wheelchair access to the changing table, toilet and hand-rinse basin;
- transfer from a wheelchair to the toilet or changing table;
- use of the toilet;
- use of a hoist;
- changing older children/adults with continence problems;
- disposal of soiled nappies/continence pads;
- hand rinsing;
- personal washing.

5.75 ‘Changing Places’ toilets provide the right equipment, including a changing bench and hoist, to support disabled people who cannot use standard accessible toilets. The range of people who might use a ‘Changing Places’ toilet includes:

- people with profound and multiple learning disabilities;

- people with conditions that may affect their movement, including cerebral palsy, multiple sclerosis, motor neurone disease;
- people with head injuries or severe spinal injuries;
- people living with stroke;
- older people who require assistance.

5.76 Where provided, they should be in public areas for ease of access to everyone who needs to use them.

5.77 Comprehensive guidance on the design and equipment which should be provided in these toilets together with advice on health and safety and day-to-day operational management is available in:

- ‘Changing Places: the practical guide’, published by the Changing Places Consortium and available as a download from <http://changing-places.org/>; and
- BS 8300:2009, Design of buildings and their approaches to meet the needs of disabled people – Code of practice.

¹ The Changing Places Consortium launched its campaign in 2006 on behalf of people who cannot use standard accessible toilets. To use the toilet in safety and comfort, many people need to be able to access a ‘Changing Places’ toilet. See <http://www.changing-places.org/> for details.

References

Health Building Note 00-10 Part C – ‘Sanitary assemblies’.

Changing Places website.

Approved Document M (2010).

BS 8300:2009.



Department
of Health

© Crown copyright 2016

2905163 Produced by Williams Lea for the Department of Health