

STATUS IN NHSSCOTLAND  
**BEST PRACTICE GUIDANCE**

**Health Building Note 00-03**

Core elements:

Clinical and  
clinical support spaces

**DOH Document Code Part - DOH Document Title and Name**

This document must be read in conjunction with current Scottish Government Policy and NHSScotland Guidance, which take precedence. These include publications in both: [www.sehd.scot.nhs.uk/](http://www.sehd.scot.nhs.uk/) and [www.hfs.scot.nhs.uk/publications/](http://www.hfs.scot.nhs.uk/publications/).

**Specific updates for NHSScotland use:****Chapter 9 Generic clinical support spaces: Facilities management****Cleaners' room**

9.4 Space requirements should be determined by the equipment list agreed by domestic staff for the spaces/area to be cleaned, as compliant with SHF 30 and National Cleaning Standards, including colour coded equipment where required.

9.5 The room layout should if practicable indicate clean /dirty zones. Either, a combined bucket sink and handrinse basin (janitorial unit), or a low bucket sink with separate handrinse basin, are acceptable and compliant with SHTM 64 solutions. To be determined locally.

9.6 as 9.4 above.

Figure 86 The layout shown of approximately 8m<sup>2</sup> is indicative only, and requires to be tested to determine both sufficiency and efficiency to fulfil local and national infection control requirements. (For information, recent work by the NHSScotland Domestic Advisory Group suggest a 10m<sup>2</sup> cleaners room could be appropriate for clinical areas within hospitals.)

## Core elements

# Health Building Note 00-03: Clinical and clinical support spaces

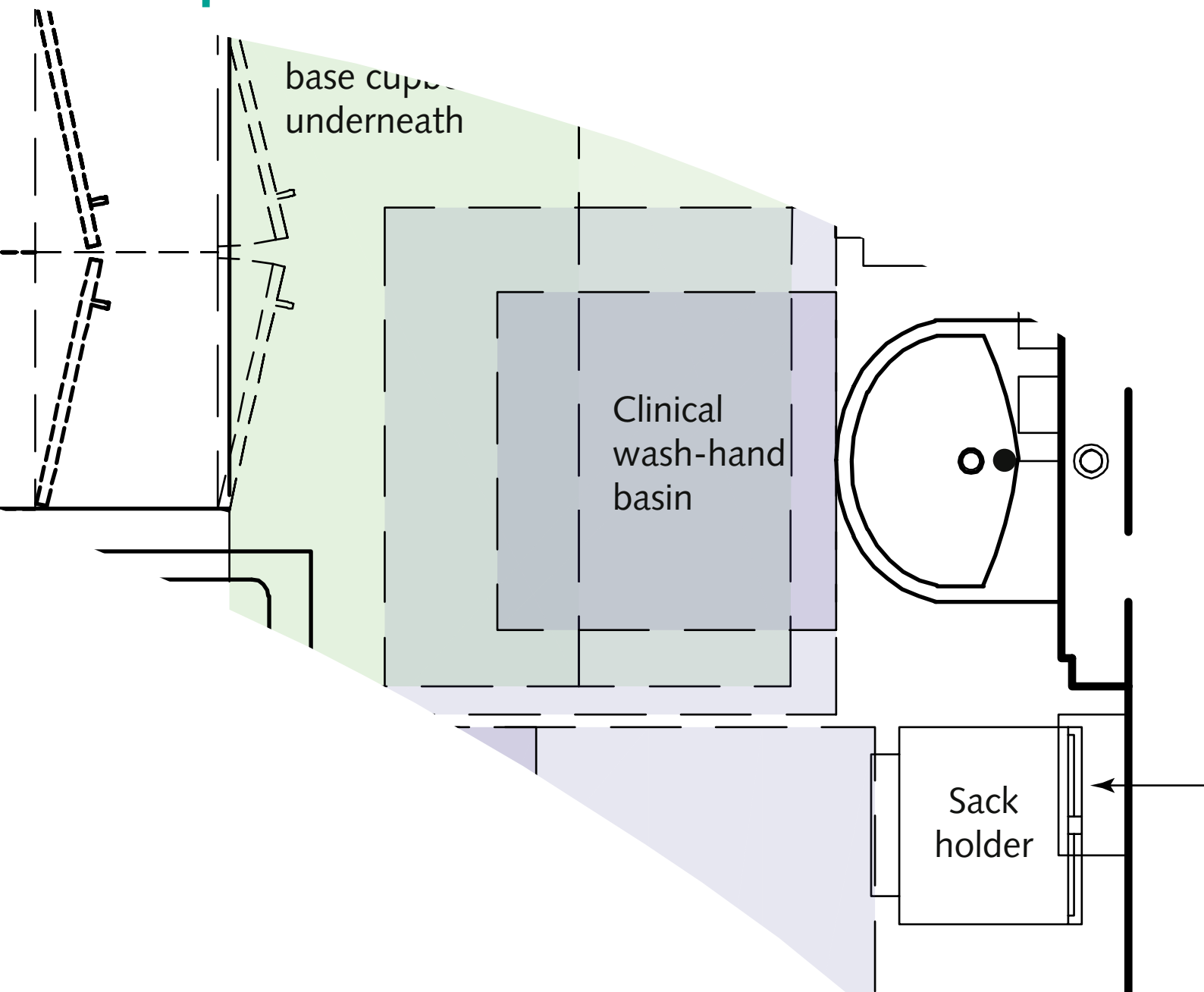

# **Health Building Note 00-03**

## **Clinical and clinical support spaces**

© Crown copyright 2013

Terms of use for this guidance can be found at <http://www.nationalarchives.gov.uk/doc/open-government-licence/>

# Preface

## About Health Building Notes

Health Building Notes give “best practice” guidance on the design and planning of new healthcare buildings and on the adaptation/extension of existing facilities.

They provide information to support the briefing and design processes for individual projects in the NHS building programme.

## The Health Building Note suite

Healthcare delivery is constantly changing, and so too are the boundaries between primary, secondary and tertiary care. The focus now is on delivering healthcare closer to people’s homes.

The Health Building Note framework (shown below) is based on the patient’s experience across the spectrum of care from home to healthcare setting and back, using the national service frameworks (NSFs) as a model.

## Health Building Note structure

The Health Building Notes have been organised into a suite of 17 core subjects.

**Care-group-based** Health Building Notes provide information about a specific care group or pathway but cross-refer to Health Building Notes on **generic (clinical) activities** or **support systems** as appropriate.

Core subjects are subdivided into specific topics and classified by a two-digit suffix (-01, -02 etc), and may be further subdivided into Supplements A, B etc.

All Health Building Notes are supported by the overarching Health Building Note 00 in which the key areas of design and building are dealt with.

### Example

The Health Building Note on accommodation for adult in-patients is represented as follows:

“Health Building Note 04-01: Adult in-patient facilities”

The supplement to Health Building Note 04-01 on isolation facilities is represented as follows:

“Health Building Note 04-01: Supplement 1 – Isolation facilities for infectious patients in acute settings”

Health Building Note number and series title	Type of Health Building Note
Health Building Note 00 – Core elements	Support-system-based
Health Building Note 01 – Cardiac care	Care-group-based
Health Building Note 02 – Cancer care	Care-group-based
Health Building Note 03 – Mental health	Care-group-based
Health Building Note 04 – In-patient care	Generic-activity-based
Health Building Note 05 – Older people	Care-group-based
Health Building Note 06 – Diagnostics	Generic-activity-based
Health Building Note 07 – Renal care	Care-group-based
Health Building Note 08 – Long-term conditions/long-stay care	Care-group-based
Health Building Note 09 – Children, young people and maternity services	Care-group-based
Health Building Note 10 – Surgery	Generic-activity-based
Health Building Note 11 – Community care	Generic-activity-based
Health Building Note 12 – Out-patient care	Generic-activity-based
Health Building Note 13 – Decontamination	Support-system-based
Health Building Note 14 – Medicines management	Support-system-based
Health Building Note 15 – Emergency care	Care-group-based
Health Building Note 16 – Pathology	Support-system-based

## Other resources in the DH Estates and Facilities knowledge series

### Health Technical Memoranda

Health Technical Memoranda give comprehensive advice and guidance on the design, installation and operation of specialised building and engineering technology used in the delivery of healthcare (for example medical gas pipeline systems, and ventilation systems).

They are applicable to new and existing sites, and are for use at various stages during the inception, design, construction, refurbishment and maintenance of a building.

All Health Building Notes should be read in conjunction with the relevant parts of the Health Technical Memorandum series.

### Activity DataBase (ADB)

The Activity DataBase (ADB) data and software assists project teams with the briefing and design of the healthcare environment. Data is based on guidance given in the Health Building Notes, Health Technical Memoranda and Health Technical Memorandum Building Component series.

1. Room data sheets provide an activity-based approach to building design and include data on personnel, planning relationships, environmental considerations, design character, space requirements and graphical layouts.
2. Schedules of equipment/components are included for each room, which may be grouped into ergonomically arranged assemblies.
3. Schedules of equipment can also be obtained at department and project level.
4. Fully loaded drawings may be produced from the database.
5. Reference data is supplied with ADB that may be adapted and modified to suit the users' project-specific needs.

### Note

The sequence of numbering within each subject area does not necessarily indicate the order in which the Health Building Notes were or will be published/printed. However, the overall structure/number format will be maintained as described.

# Executive summary

Health Building Note 00-03 – ‘Clinical and clinical support spaces’ provides evidence-based best practice guidance on the design and layout of generic clinical and clinical support spaces for use in healthcare settings.

Room sizes have been standardised wherever possible. For clinical support areas where a standard room size is not appropriate, this document provides a sizing methodology suitable for briefing purposes. Most of the indicative room layouts are informed by one or more ergonomic drawings.

In places, the guidance differs from that provided in Approved Document M (2010) and BS 8300:2001 (2009 edition). Where this is the case, the reasons for the variations are discussed.





# Contents

## Preface

About Health Building Notes  
The Health Building Note suite  
Health Building Note structure  
Other resources in the DH Estates and Facilities knowledge series  
    Health Technical Memoranda  
    Health Technical Memorandum Building Component series  
    Activity DataBase (ADB)  
How to obtain publications

## Executive summary

### **1 Introduction**

Purpose and scope of this document  
Principle of using generic rooms wherever possible  
Standardised room sizes  
Evidence base

### **2 Generic clinical spaces: Beds**

Single-bed room  
    Room description and layout  
Multi-bed room  
    Room description and layout

### **3 Generic clinical spaces: Consulting, examination and interview spaces**

Consulting room  
    Room description and layout  
    Separate versus combined consulting and examination rooms  
    Ergonomic drawings  
Consulting/examination room: double-sided couch access  
    Room description and layout  
    Separate versus combined consulting and examination rooms  
    Ergonomic drawings  
Consulting/examination room: single-sided couch access  
    Room description and layout  
    Ergonomic drawings  
Examination/physical therapy room  
    Room description and layout  
    Separate versus combined consulting and examination rooms  
    Ergonomic drawings  
Interview room: 4 places  
    Room description and layout  
    Ergonomic drawings  
Interview room: 7 places  
    Room description and layout  
    Ergonomic drawings

### **4 Generic clinical spaces: Group rooms**

Free movement exercise room

1

2

8

38

	Room description and layout	
	Ergonomic drawings	
	Group room	
	Room description and layout	
	Meeting room: 7 places	
	Room description and layout	
	Ergonomic drawings	
	Meeting room: 16 places	
	Room description and layout	
	Ergonomic drawings	
	Seminar room	
	Room description and layout	
	Ergonomic drawings	
<b>5</b>	<b>Generic clinical spaces: Recovery spaces</b>	<b>47</b>
	Recovery/assessment room	
	Room description and layout	
	Ergonomic drawings	
	Seated recovery area	
	Room description	
<b>6</b>	<b>Generic clinical spaces: Treatment rooms</b>	<b>53</b>
	Treatment room: all-round couch access	
	Room description and layout	
	Ergonomic drawings	
	Treatment room: double-sided couch access	
	Room description and layout	
	Ergonomic drawings	
<b>7</b>	<b>Generic clinical support spaces: Entrance, reception and waiting</b>	<b>66</b>
	Children's play area	
	Room description	
	Infant feeding room	
	Room description	
	Information/resource centre	
	Room description	
	Reception desk	
	Room description	
	Waiting area	
	Room description	
<b>8</b>	<b>Generic clinical support spaces: Utility</b>	<b>69</b>
	Clean supply room	
	Room description and layout	
	Ergonomic drawings	
	Clean utility room without controlled drugs cupboard	
	Room description and layout	
	Ergonomic drawings	
	Clean utility room	
	Room description and layout	
	Ergonomic drawings	
	Dirty utility room for bedpan processing	
	Room description and layout	
	Ergonomic drawings	
	Dirty utility room	
	Room description and layout	
	Medicine store/preparation room	

	Room description and layout	
	Ergonomic drawings	
<b>9</b>	<b>Generic clinical support spaces: Facilities management</b>	<b>99</b>
	Cleaners' room	
	Room description and layout	
	Ergonomic drawings	
	Central cleaners' room	
	Room description	
	Disposal hold: 1700 litres	
	Room description and layout	
<b>10</b>	<b>Generic clinical support spaces: Refreshments and rest</b>	<b>104</b>
	Mini kitchen	
	Room description and layout	
	Ergonomic drawings	
	Pantry/refreshment room	
	Room description and layout	
	Rest room with mini kitchen	
	Room description and layout	
	Ergonomic drawings	
<b>11</b>	<b>Generic clinical support spaces: Miscellaneous</b>	<b>118</b>
	Near patient testing room	
	Room description and layout	
	Ergonomic drawings	
	Parking bay	
	Room description	
	Relatives' overnight stay	
	Room description and layout	
	Ergonomic drawings	
<b>12</b>	<b>Generic clinical admin spaces: Open-plan admin areas</b>	<b>124</b>
	Admin area: continuous use	
	Room description and layout	
	Ergonomic drawings	
	Admin area: shared use	
	Room description and layout	
	Ergonomic drawings	
	Breakout space	
	Room description and layout	
	Ergonomic drawings	
	Quiet workspace	
	Room description and layout	
	Staff communication base	
	Room description and layout	
	Touchdown base	
	Room description and layout	
	Ergonomic drawings	
<b>13</b>	<b>Generic clinical admin spaces: Offices</b>	<b>140</b>
	Office/meeting room	
	Room description and layout	
	Ergonomic drawings	
	Office: 1-person	
	Room description and layout	
	Ergonomic drawings	
	Office: 2-person	

<b>14 Specialist spaces</b>	Room description and layout Ergonomic drawings	<b>147</b>
	Plaster room	
	Room description and layout Ergonomic drawings	
<b>References</b>		<b>153</b>

# 1 Introduction

1.1 Health Building Note 00-03 provides design guidance and indicative room layouts of generic clinical and clinical support spaces in healthcare buildings.

## Purpose and scope of this document

- 1.2 Most of the layouts are informed by one or more ergonomic drawings (the colour-coding on the room layouts relates to ergonomic information). Both the ergonomic drawings and indicative room layouts aim to enable spaces to be designed that are fit for purpose, accessible, safe and secure.
- 1.3 The indicative room layouts represent example design solutions, not specific recommendations. Actual requirements should be determined on an individual project basis.
- 1.4 Although primarily applicable to new buildings, the recommendations contained within this guidance should also be applied, where practical, when existing facilities are being upgraded.

## Principle of using generic rooms wherever possible

1.5 Generic rooms are designed to accommodate a range of activities rather than being tailored for a single function/specialty or narrow range of functions.

1.6 Clinical and clinical support rooms should be generic wherever possible to maximise flexibility in use. Generic rooms make up a high proportion of the clinical and clinical support spaces within healthcare buildings.

## Standardised room sizes

- 1.7 The size (and dimensions) of the indicative room layouts have been standardised wherever possible. This may mean sizing up to some extent, but results in rooms that can be adapted (for alternative use) much more easily.
- 1.8 For clinical support areas where a standard room size is not appropriate, this document provides a sizing methodology suitable for briefing purposes.
- 1.9 Where special departmental requirements warrant a variation from the spaces described in this document, information is provided in the relevant guidance.

## Evidence base

1.10 This document is based on the professional opinion of healthcare planning and design experts and ergonomic research (published and unpublished).

## 2 Generic clinical spaces: Beds

### Single-bed room

#### Room description and layout

2.1 There are three distinct categories of direct activity that take place at the bedside:

- clinical treatment and care:
  - (i) admission, with the intimate discussion of personal matters;
  - (ii) specific medical and nursing interventions and observation;
  - (iii) rehabilitation;
  - (iv) informing, discussing, listening and advising both patients and relatives;
- personal care and maintenance:
  - (i) sleeping and resting;
  - (ii) eating, drinking, washing and toileting;
  - (iii) entertainment/diversion, reading, watching the television;
  - (iv) receiving visitors;
- support activities:
  - (i) preparation of clinical procedures;
  - (ii) maintaining records;
  - (iii) holding stores;
  - (iv) communicating;
  - (v) developing staff skills.

2.2 The example layout for a single-bed room (see [Figure 1](#)) shows the zones to enable these activities to take place around a bed space.

2.3 The bed space should allow procedures to be carried out from either side of the bed with adequate circulation space so that medical emergency teams and equipment can gain access to the patient. There should be adequate space for moveable furniture and unobstructed access for

wheelchairs, as well as space to accommodate overnight visitors.

2.4 All single rooms should be provided with en-suite sanitary facilities and all bed spaces should be provided with:

- furniture:
  - (i) a variable-height bed;
  - (ii) a bedside locker, with a lockable compartment for storing medication;
  - (iii) an overbed table;
  - (iv) a bedhead luminaire;
  - (v) space for a relative's overnight stay bed;
  - (vi) space for storing clothes and shoes;
  - (vii) a small refrigerator for a patient's personal use (optional).
- a co-ordinated bedhead services arrangement incorporating:
  - (i) electrical socket-outlets;
  - (ii) luminaire control switch;
  - (iii) oxygen, medical air and vacuum outlets;
- a patient services system (which may be incorporated into the bedhead services panel) including:
  - (i) help call button, including two-way speech facilities (consideration might also be given to alternative call systems, such as blow devices, for patients who cannot use their hands);
  - (ii) reassurance light;
  - (iii) luminaire switch;
- patient entertainment facilities including:
  - (i) TV;
  - (ii) radio;
  - (iii) telephone;

- (iv) headset outlet;
  - facilities for staff:
    - (i) a clinical wash-hand basin, plus antibacterial hand-rub dispensers;
    - (ii) a clinical support zone with data outlet;
    - (iii) storage for a day's supply of linen and surgical goods/supplies.
- 2.5 These provisions are necessary as the basis of a desirable environment.
- 2.6 The [layout for a single-bed room \(see Figure 1\)](#) is an example only. Its purpose is to illustrate how the different elements of the room – bed space, en-suite, clinical support zone, and family zone – can be brought together. Other configurations are possible.
- 2.7 In the design of the example layout, the following issues have been considered:
- clear space around the bed (3600 mm × 3700 mm);
  - position of the en-suite shower room;
  - bedroom door width into the room;
  - location of the clinical wash-hand basin;
  - provision of support facilities including space for a fold-down divan;
  - sightlines from the corridor (at the doorway).
- 2.8 It is assumed that conventional bedhead services are used, although the use of ceiling- or wall-mounted pendant fittings is possible.
- 2.9 The en-suite – comprising WC, washbasin and shower – is shown with a chamfered profile. For a rectangular layout, refer to 'Shower rooms' in Health Building Note 00-02 – 'Sanitary spaces'.



Figure 1 Example layout for a single-bed room

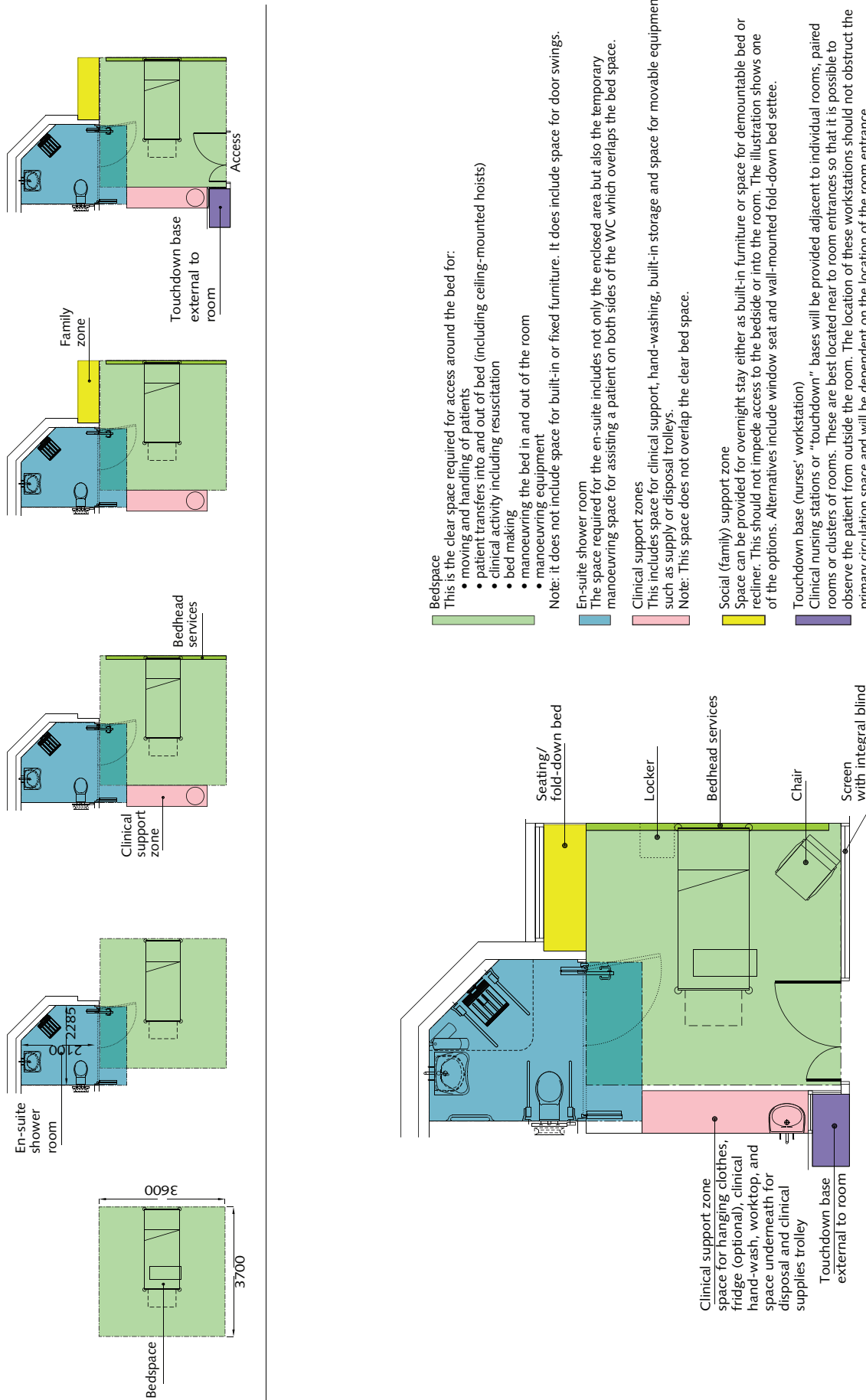

## Multi-bed room

### Room description and layout

- 2.10 There are three distinct categories of direct activity that take place at the bedside:
- clinical treatment and care:
    - (i) admission, with the intimate discussion of personal matters;
    - (ii) specific medical and nursing interventions and observation;
    - (iii) rehabilitation;
    - (iv) informing, discussing, listening and advising both patients and relatives;
  - personal care and maintenance:
    - (i) sleeping and resting;
    - (ii) eating, drinking, washing and toileting;
    - (iii) entertainment/diversion, reading, watching the television;
    - (iv) receiving visitors;
  - support activities:
    - (i) preparation of clinical procedures;
    - (ii) maintaining records;
    - (iii) holding stores;
    - (iv) communicating;
    - (v) developing staff skills.
- 2.11 The example layout for a single-bed room shows the zones to enable these activities to take place around a bed space. In a multi-bed room (see [Figure 2](#)) the different activity zones move to a greater or lesser degree further away from the bedside, and may be shared to support all the beds in the multi-bed room.
- 2.12 The preferred maximum number of beds in a multi-bed room is four. This enables the potential for better gender separation and improved privacy within a 24-bed ward comprising six four-bed rooms. It also gives each patient a corner as a “home base” and a neighbour on one side only.
- 2.13 The bed space should allow procedures to be carried out from either side of the bed with adequate circulation space so that medical emergency teams and equipment can gain access to the patient. There should be adequate space for moveable furniture and unobstructed access for wheelchairs, as well as space to accommodate overnight visitors.
- 2.14 All multi-bed rooms should be provided with en-suite sanitary facilities and all bed spaces should be provided with:
- furniture:
    - (i) a variable-height bed;
    - (ii) a bedside locker, with a lockable compartment for storing medication;
    - (iii) an overbed table;
    - (iv) a bedhead luminaire;
  - a co-ordinated bedhead services arrangement incorporating:
    - (i) electrical socket-outlets;
    - (ii) luminaire control switch;
    - (iii) oxygen, medical air and vacuum outlets;
  - a patient services system (which may be incorporated into the bedhead services panel) including:
    - (i) help call button, including two-way speech facilities (consideration might also be given to alternative call systems, such as blow devices, for patients who cannot use their hands);
    - (ii) reassurance light;
    - (iii) luminaire switch;
  - patient entertainment facilities including:
    - (i) TV;
    - (ii) radio;
    - (iii) telephone;
    - (iv) headset outlet;
  - facilities for staff:
    - (i) a clinical wash-hand basin, plus antibacterial hand-rub dispensers;
    - (ii) a clinical support zone with data outlet;
    - (iii) storage for a day’s supply of linen and surgical goods/supplies.
- 2.15 These provisions are necessary as the basis of a desirable environment.
- 2.16 In multi-bed rooms each bed space should be separated to provide a degree of privacy. If curtains are used they should be shadow-proof and flame-

- retardant. When full-height curtains are drawn, the bed space should still be well illuminated and ventilated. Curtains may be disposable. Highly-patterned curtains should be avoided, as they can cause visual disturbances in patients who are confused or heavily sedated.
- 2.17 Each four-bed room should include two clinical wash-hand basins for staff use. These should be located to be highly visible and convenient for staff to use, both on entering and leaving the room and when moving from one patient to another. A clinical support zone with space for a computer and storage for a day's supply of linen and clinical goods is required for each multi-bed bay.
- 2.18 Design teams should decide in consultation with the local fire authority whether multi-bed rooms should or should not be fitted with doors for fire safety reasons, for example to limit the spread of smoke. The infection control team should also be consulted on the use of doors in multi-bed rooms.
- 2.19 Each multi-bed room should have easy access to informal social space, as the majority of patients, although highly dependent, are encouraged out of bed.
- 2.20 The layout for a multi-bed room is an example only. It shows a four-bed room with an assisted shower room and a second semi-ambulant WC, both en-suite.
- 2.21 An en-suite with fully opening wall cannot be used in this layout because of the loss of privacy in a multiple-occupancy room. Each en-suite has an outward-opening single-leaf door. The two en-suites are located inboard, forming a recess at the entrance to the bed areas, providing some privacy to the bed areas. Two clinical wash-hand basins are located centrally, one next to the room entrance and the other on the outside wall. There is room for one clinical support zone.

Figure 2 Multi-bed room layout

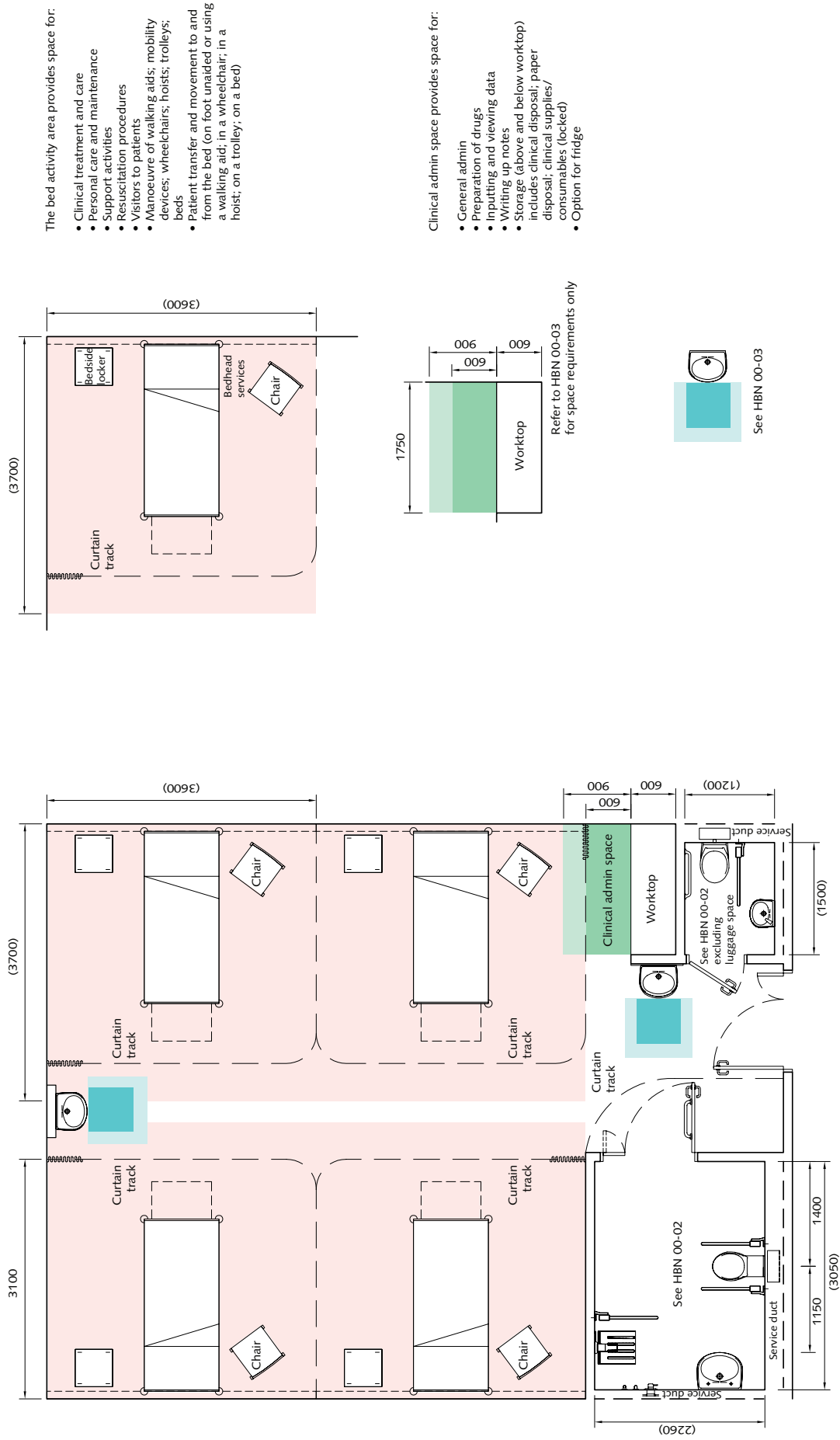

### 3 Generic clinical spaces: Consulting, examination and interview spaces

#### Consulting room

##### Room description and layout

3.1 For future flexibility (adaptability) the size of a standard consulting room should be around 12 m<sup>2</sup>. However, the absolute minimum recommended area is 8 m<sup>2</sup>.

3.2 The room layout provided (see Figure 3) means the patient/client will be positioned between the practitioner and the door during consultation. Consideration may be given to altering the layout to position the practitioner between the patient/client and the door for staff safety.

Figure 3 Consulting room

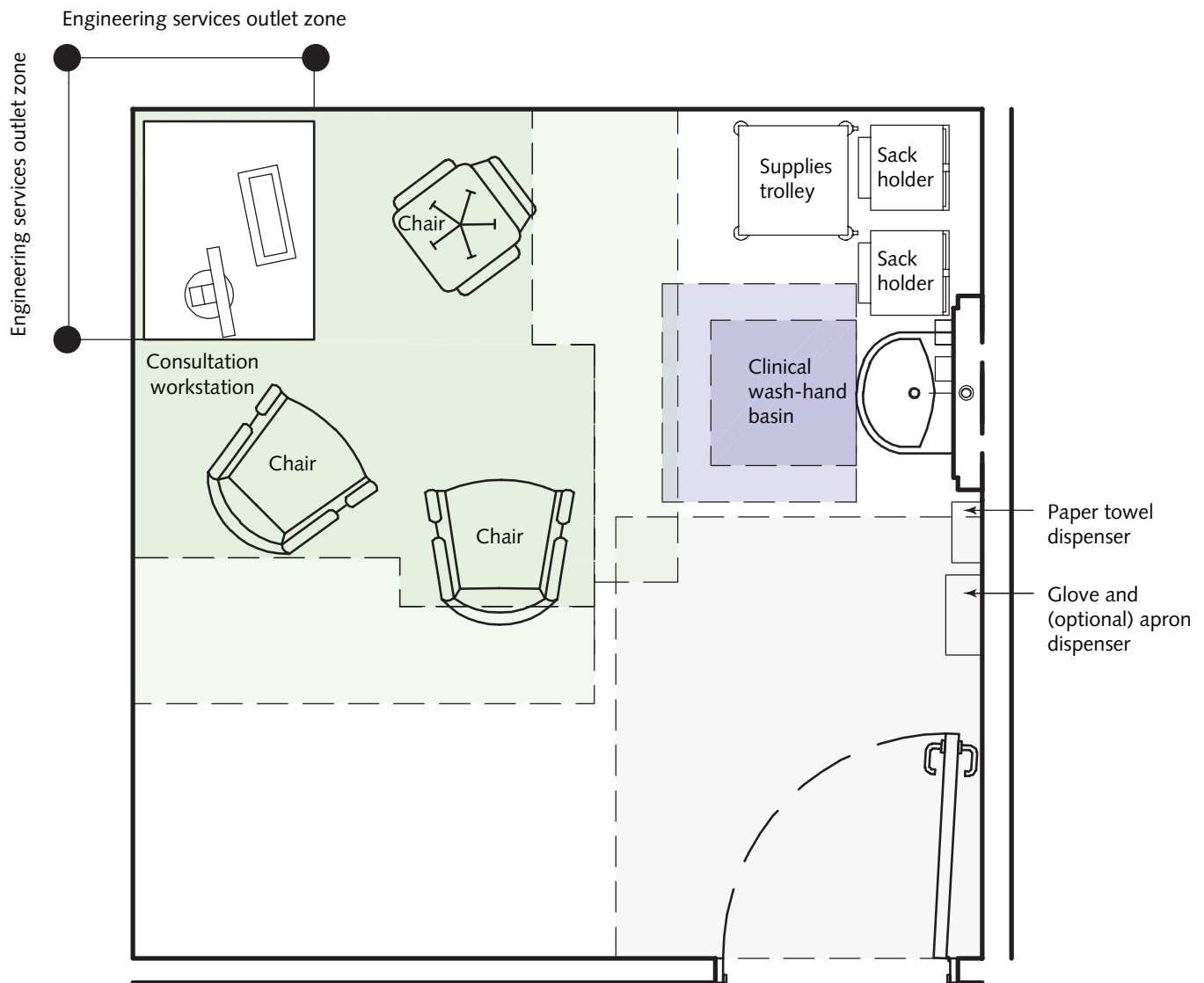

### Separate versus combined consulting and examination rooms

- 3.3 Separate consulting and examination rooms (see Figure 4) do not provide the flexibility of combined consulting/examination rooms although they may be required for certain clinics.
- 3.4 Where separate consulting and examination rooms are provided, there should not be adjoining doors between adjacent examination rooms for reasons of patient privacy.
- 3.5 A comparison of the space requirements and utilisation of four combined consulting/examination rooms against two consulting rooms and four examination rooms shows the combined rooms require less space and offer greater utilisation.

Figure 4 Combined versus separate consulting and examination rooms

Example 1: 4 Consulting/examination rooms (@ 16 m<sup>2</sup>)

Range of uses:

1–4 doctors

1–4 clinic sessions

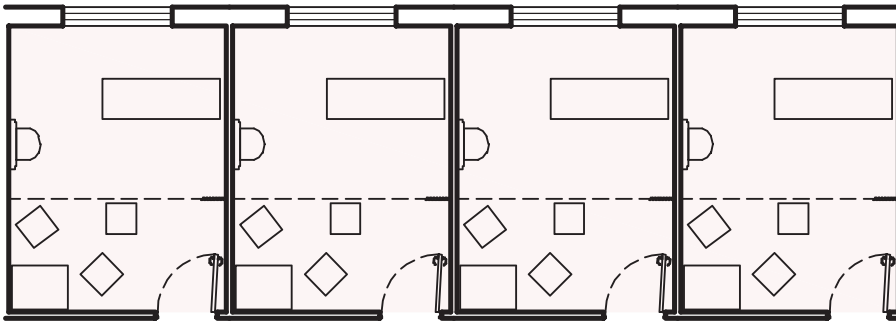

Example 2: 2 Consulting and 4 examination rooms (@ 12 m<sup>2</sup>)

Range of uses:

1–2 doctors

1–2 clinic sessions

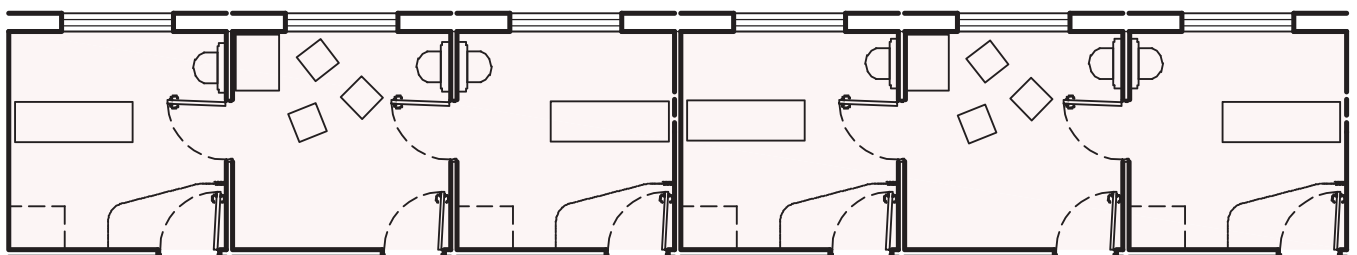

## Ergonomic drawings

### Consultation workstation

3.6 This ergonomic drawing (see Figure 5) shows a nominal space requirement for a consultation workstation. The actual space requirement will depend upon the design and location of the chairs and the design of the desk. The illustrated desk is the recommended minimum dimension for using a flat screen computer.

3.7 The activity space is based on the practitioner sitting at the desk with the patient/client seated diagonally opposite. The desk should not be located between the practitioner and patient/client.

3.8 It should be possible to rotate the computer monitor to allow the patient/client to view it.

3.9 The consultation desk should be positioned so that:

- the practitioner can acknowledge a patient/client on entry to the room;
- the practitioner is not be silhouetted against a window when in consultation with the patient/client.

3.10 A small lockable drawer should be available to store prescription pads if electronic prescriptions are not being used.

3.11 A small local printer may be provided.

Figure 5 Space requirement for a consultation workstation

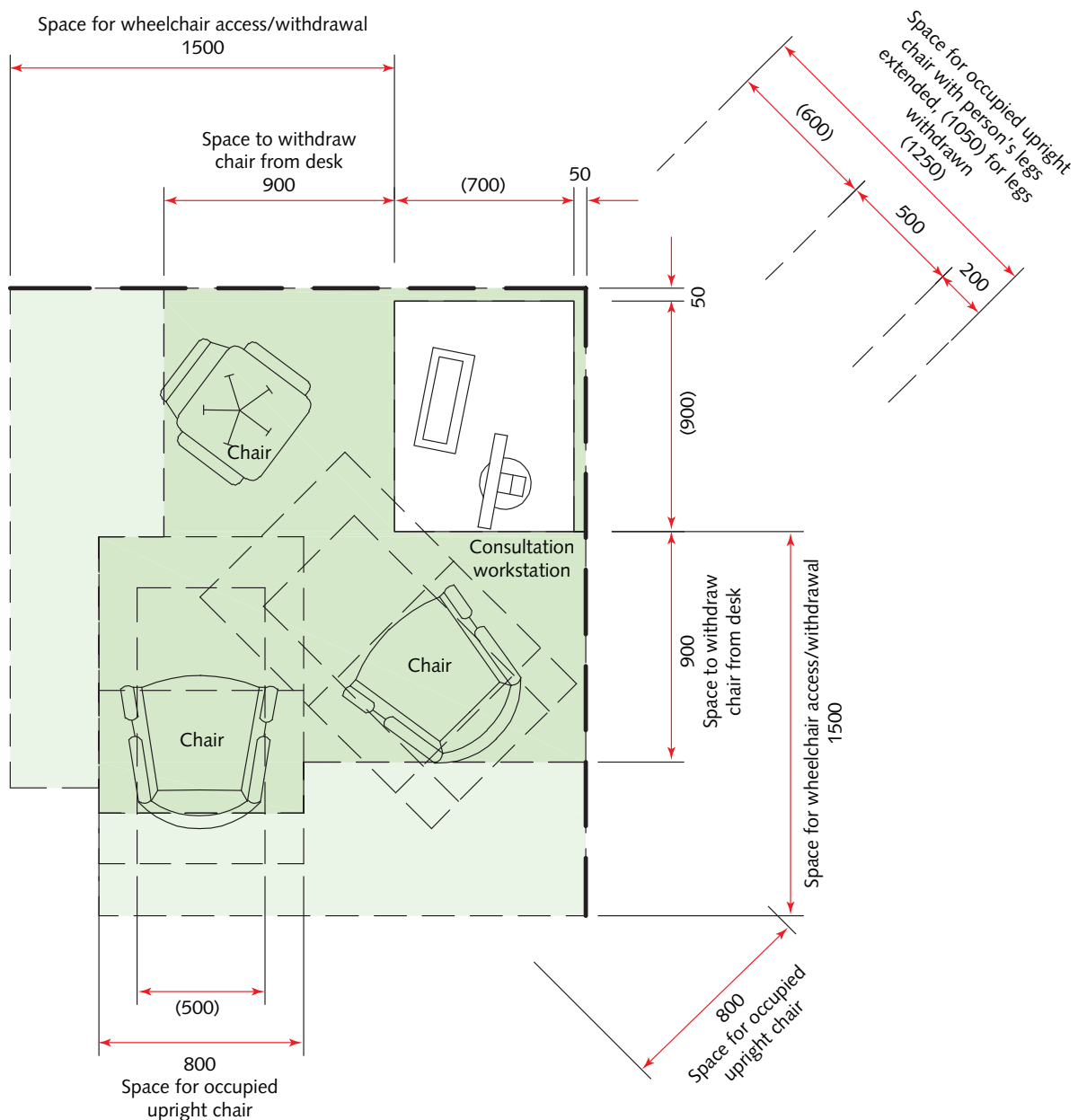

*Clinical wash-hand basin*

- 3.12 These ergonomic drawings (see Figure 6) show the space requirements for standing use of a clinical wash-hand basin assembly. For seated use, the basin will need to be lowered.
- 3.13 The basin should be fitted with non-touch taps.
- 3.14 The recommended fixing height of a lever tap on a clinical wash-hand basin is 1095 mm. Where a lever tap is used, the fixing height of the dispensers should be chosen to reduce any possible conflicts in use.
- 3.15 The illustrated clinical wash-hand basin projects 400 mm from the back panel or wall. However, clinical wash-hand basins may vary from 350 to 500 mm projection. Where basins deeper than 400 mm are used, the impact on/from other components and/or activities undertaken within any space should be considered when evaluating any room layout.
- 3.16 The glove and apron dispenser illustrated is a combined unit; this is considered the most compact solution although separate units may also be used. Even the most compact unit cannot practically be located within comfortable reach of the basin; it should, however, be conveniently located within the room.
- 3.17 The ergonomic advice for the height of horizontal elbow operated lever taps is based on the following data:  
 “Elbow height for shod, slightly bent posture (as when leaning forward) for 50%ile UK male = 1134 mm, for female 1049 mm. 1090 mm is considered the best compromise for an elbow height for both male and female use. The ergonomic advice for the height of a lever tap is 75 mm below elbow height giving a figure height of approx 1015 mm.”
- 3.18 Lever taps are not illustrated.
- 3.19 For detailed information on basins, see Health Building Note 00-10 Part C – ‘Sanitary assemblies’.

Figure 6 Space requirements for standing use of a clinical wash-hand basin assembly

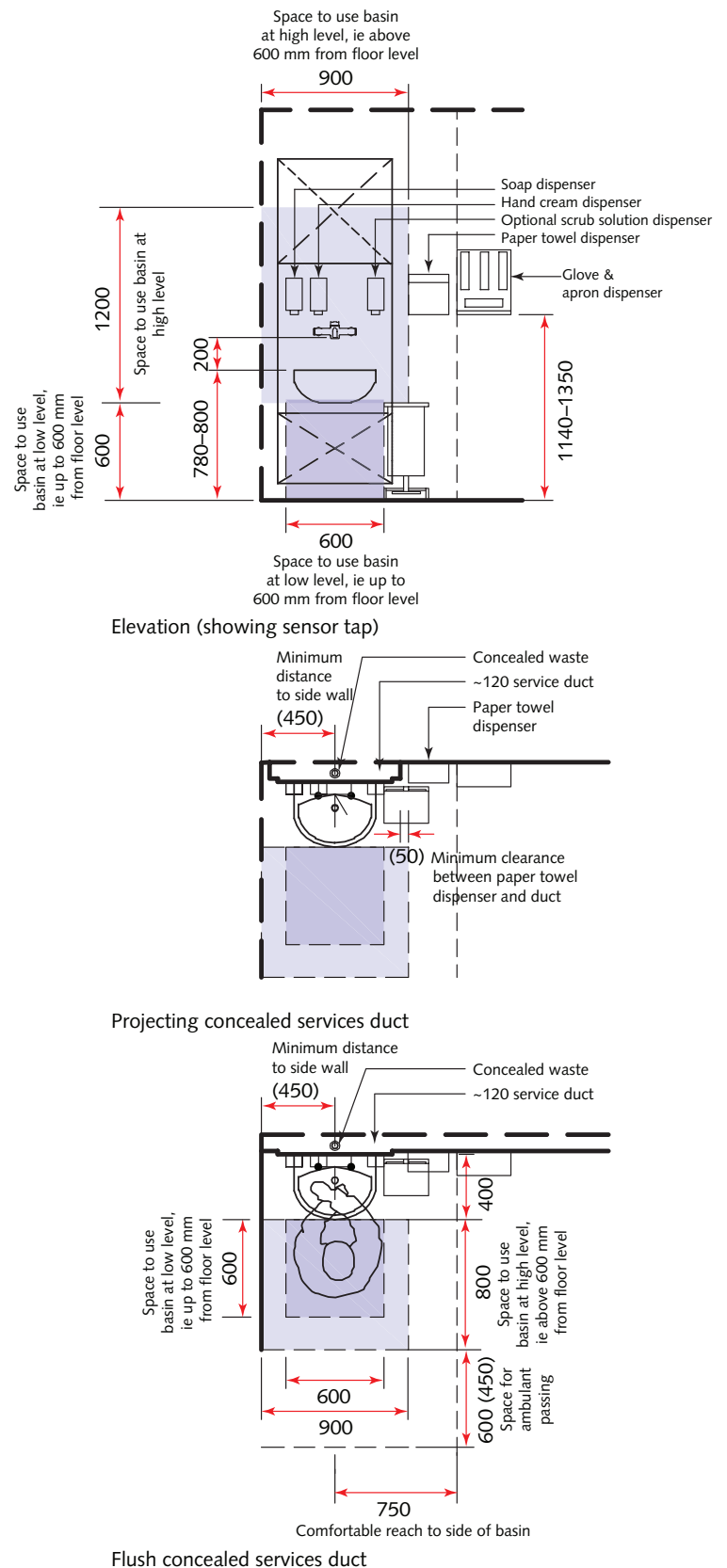



## Consulting/examination room: double-sided couch access

### Room description and layout

- 3.20 This room is intended as a flexible space for consultations and examinations for use by a wide range of specialties.
- 3.21 The following procedures may take place in this room:
- non-invasive procedures i.e. procedures that do not break the skin e.g. changing a dressing;
  - minimally invasive procedures i.e. procedures that break or puncture the skin e.g. injections, taking blood etc.
- 3.22 Where it is not necessary to access both sides of the couch, the single-sided room layout may be used but to maximise flexibility and adaptability double-sided couch access is generally recommended.
- 3.23 The layout shows the clinical wash-hand basin within the curtained examination area. However, its location should be subject to local policy and infection control advice. It must be easily accessible from both the consultation and examination areas. The curtain should be located to prevent it becoming contaminated from use of the clinical wash-hand basin.
- 3.24 Piped medical gases are generally not required. In emergency situations it is anticipated that bottled oxygen and mobile suction equipment will be readily available.
- 3.25 Two room layouts have been provided (see [Figures 7 and 8](#)). Both include a standard three-section couch. In both options, the patient/client is positioned between the member of clinical staff and the door during consultation. Consideration may be given to altering the layout to position the practitioner between the patient/client and the door for staff safety.
- 3.26 In option 1, the consultation space will benefit from natural light if a window is installed in the wall opposite the door, and is ideally positioned for greeting the patient/client. If a window is provided as suggested, solar shading and/or a blind may be necessary to ensure that the practitioner is not silhouetted from the light behind.
- 3.27 Option 2 is identical to option 2 of the treatment room. This could aid future adaptability. It has the disadvantage of the consultation area being located on the inside wall (i.e. generally away from natural light, if a window is installed in the wall opposite the door) and the examination area being located on the outside wall (i.e. requiring privacy control due to the likely proximity of a window).
- 3.28 The primary function of the room could be considered to be consultation. However, in option 2, the examination space is immediately in front of the patient/client as they enter the room.

Figure 8 Consulting/examination room: double-sided couch access (option 2)

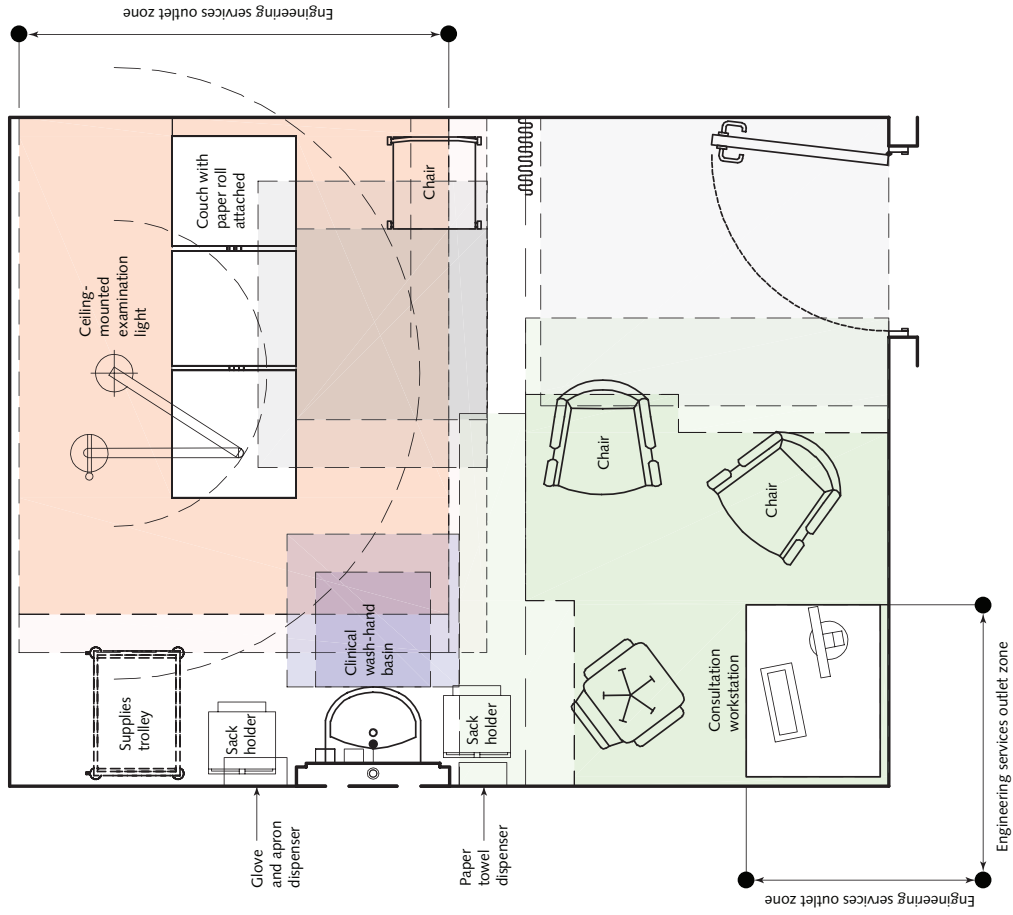
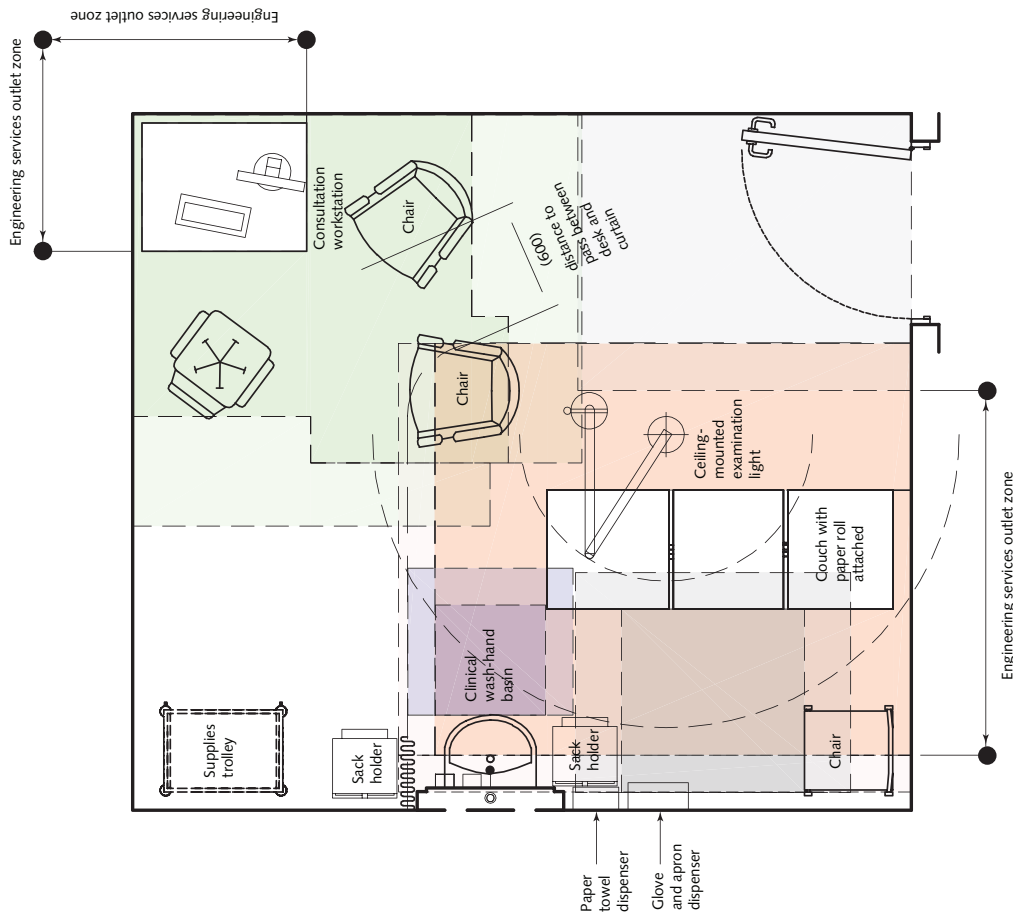

Figure 7 Consulting/examination room: double-sided couch access (option 1)



### Separate versus combined consulting and examination rooms

- 3.29 Separate consulting and examination rooms may be justified for some clinics. However, they do not provide the flexibility of combined consulting/examination rooms. See Figure 9.
- 3.30 Where separate consulting and examination rooms are provided, there should not be adjoining doors between the rooms for reasons of patient privacy.
- 3.31 A comparison of the space requirements and utilisation of four combined consulting/examination rooms against two consulting rooms and four examination rooms shows the combined rooms require less space and offer greater utilisation.

Figure 9 Combined versus separate consulting and examination rooms

Example 1: 4 Consulting/examination rooms (@ 16 m<sup>2</sup>)

Range of uses:  
1–4 doctors  
1–4 clinic sessions

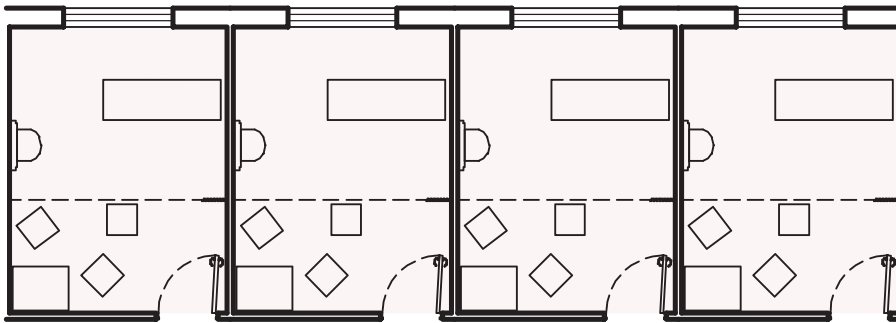

Example 2: 2 Consulting and 4 examination rooms (@ 12 m<sup>2</sup>)

Range of uses:  
1–2 doctors  
1–2 clinic sessions

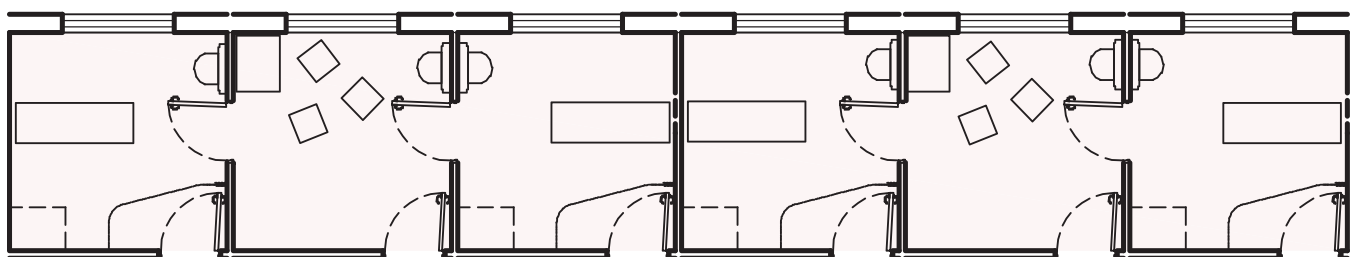

**Ergonomic drawings**

*Consultation workstation*

3.32 This ergonomic drawing (see Figure 10) shows a nominal space requirement for a consultation workstation. The actual space requirement will depend upon the design and location of the chairs and the design of the desk. The illustrated desk is the recommended minimum dimension for using a flat screen computer.

3.33 The activity space is based on the practitioner sitting at the desk with the patient/client seated diagonally opposite. The desk should not be located between the practitioner and patient/client.

3.34 It should be possible to rotate the computer monitor to allow the patient/client to view it.

3.35 The consultation desk should be positioned so that:

- the practitioner can acknowledge a patient/client on entry to the room;
- the practitioner is not be silhouetted against a window when in consultation with the patient/client.

3.36 A small lockable drawer should be available to store prescription pads if electronic prescriptions are not being used.

3.37 A small local printer may be provided.

Figure 10 Nominal space requirement for a consultation workstation

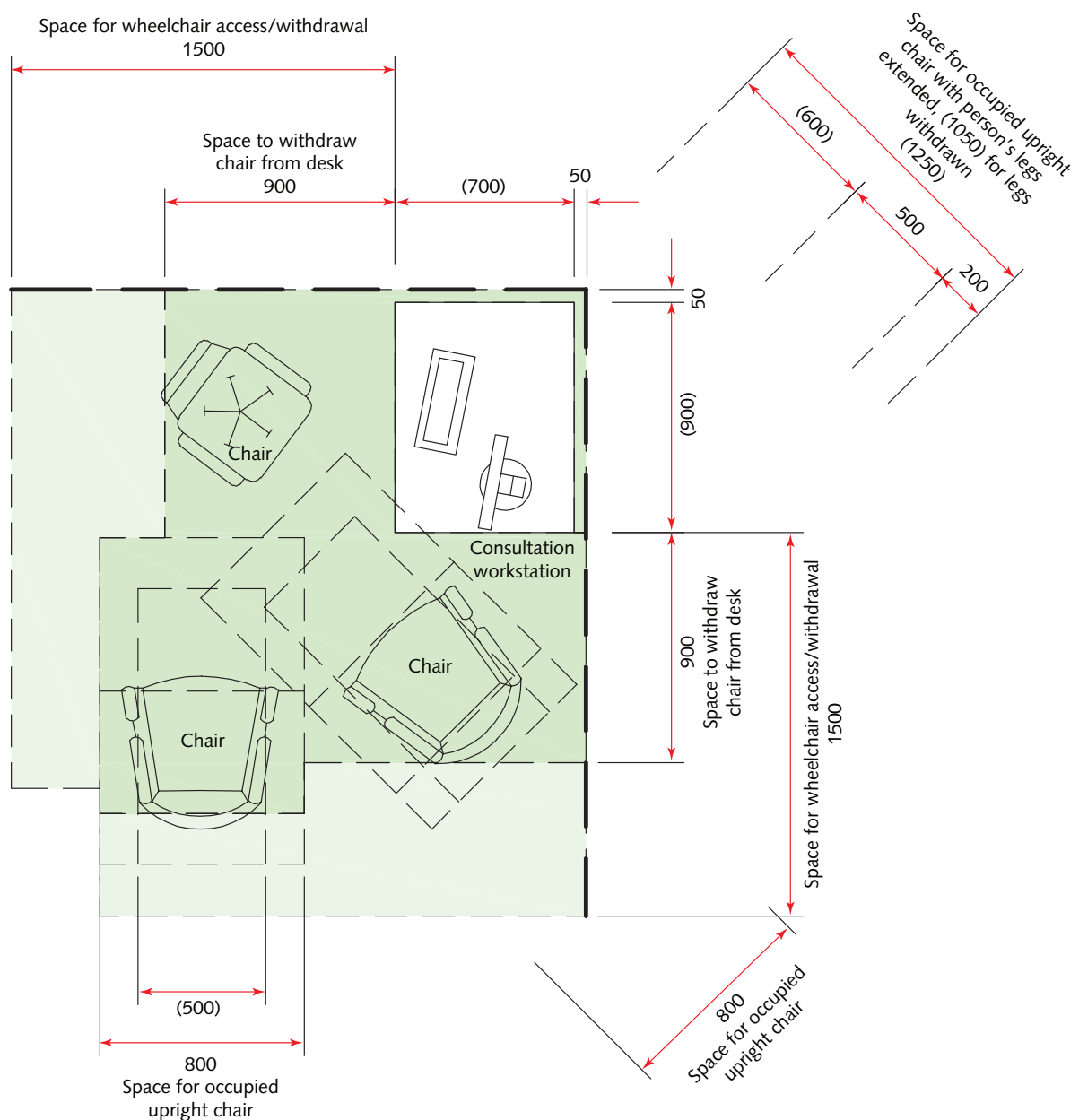

Clinical wash-hand basin

- 3.38 These ergonomic drawings (see Figure 11) show the space requirements for standing use of a clinical wash-hand basin assembly. For seated use, the basin will need to be lowered.
- 3.39 The basin should be fitted with non-touch taps.
- 3.40 The recommended fixing height of a lever tap on a clinical wash-hand basin is 1095 mm. Where a lever tap is used, the fixing height of the dispensers should be chosen to reduce any possible conflicts in use.
- 3.41 The illustrated clinical wash-hand basin projects 400 mm from the back panel or wall. However, clinical wash-hand basins may vary from 350 to 500 mm projection. Where basins deeper than 400 mm are used, the impact on/from other components and/or activities undertaken within any space should be considered when evaluating any room layout.
- 3.42 The glove and apron dispenser illustrated is a combined unit; this is considered the most compact solution although separate units may also be used. Even the most compact unit cannot practically be located within comfortable reach of the basin; it should, however, be conveniently located within the room.
- 3.43 The ergonomic advice for the height of horizontal elbow operated lever taps is based on the following data:  
 “Elbow height for shod, slightly bent posture (as when leaning forward) for 50%ile UK male = 1134 mm, for female 1049 mm. 1090 mm is considered the best compromise for an elbow height for both male and female use. The ergonomic advice for the height of a lever tap is 75 mm below elbow height giving a figure height of approx 1015 mm.”
- 3.44 Lever taps are not illustrated.
- 3.45 For detailed information on basins, see Health Building Note 00-10 Part C – ‘Sanitary assemblies’.

Figure 11 Space requirements for standing use of a clinical wash-hand basin assembly

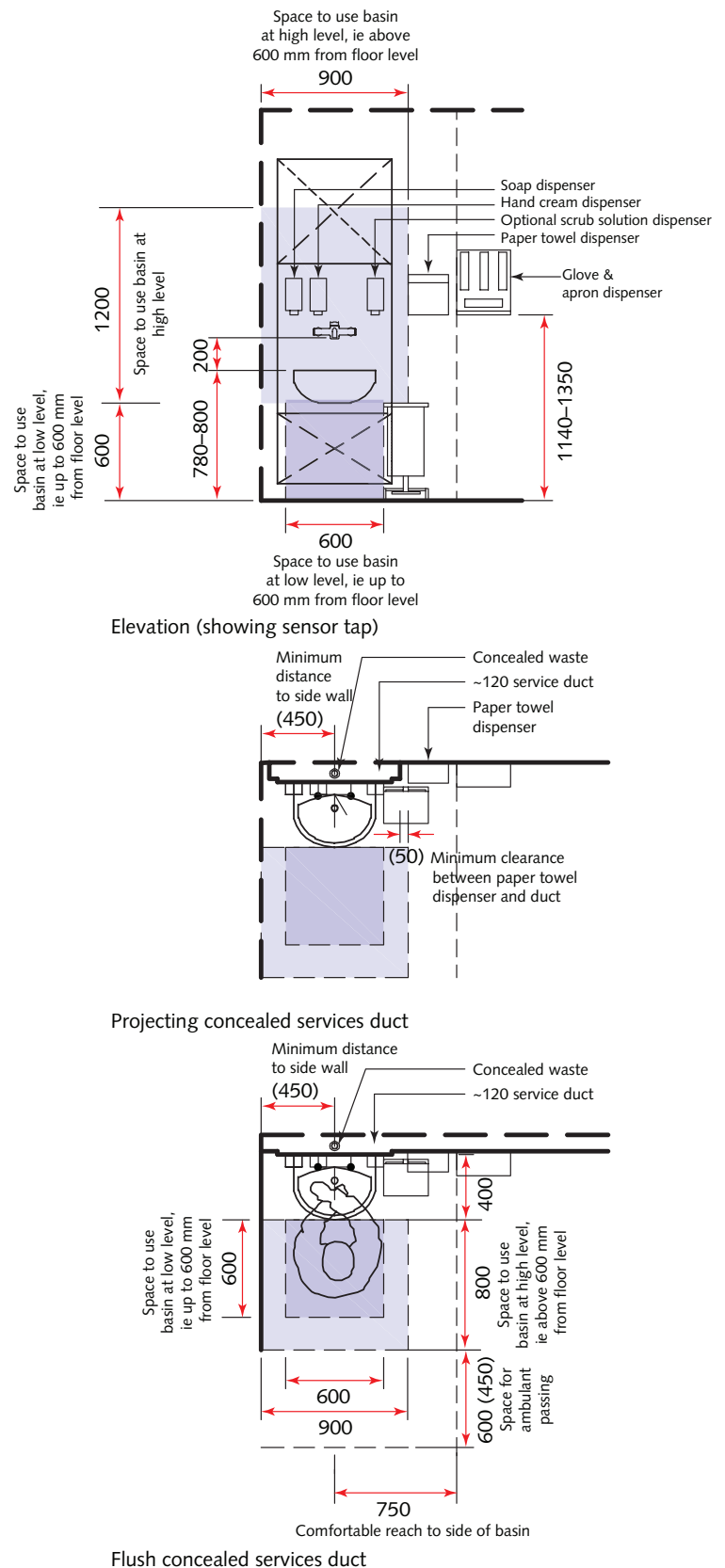

*Couch: double-sided access*

3.47 These ergonomic drawings (see Figure 12) show the space requirements for double-sided access to a three-section couch. The overall general space requirements for a three-section couch are the same as for a two-section couch.

3.48 Ceiling-mounted examination lights should be provided where double-sided couch access is required.

Figure 12 Space requirements for double-sided access to a three-section couch

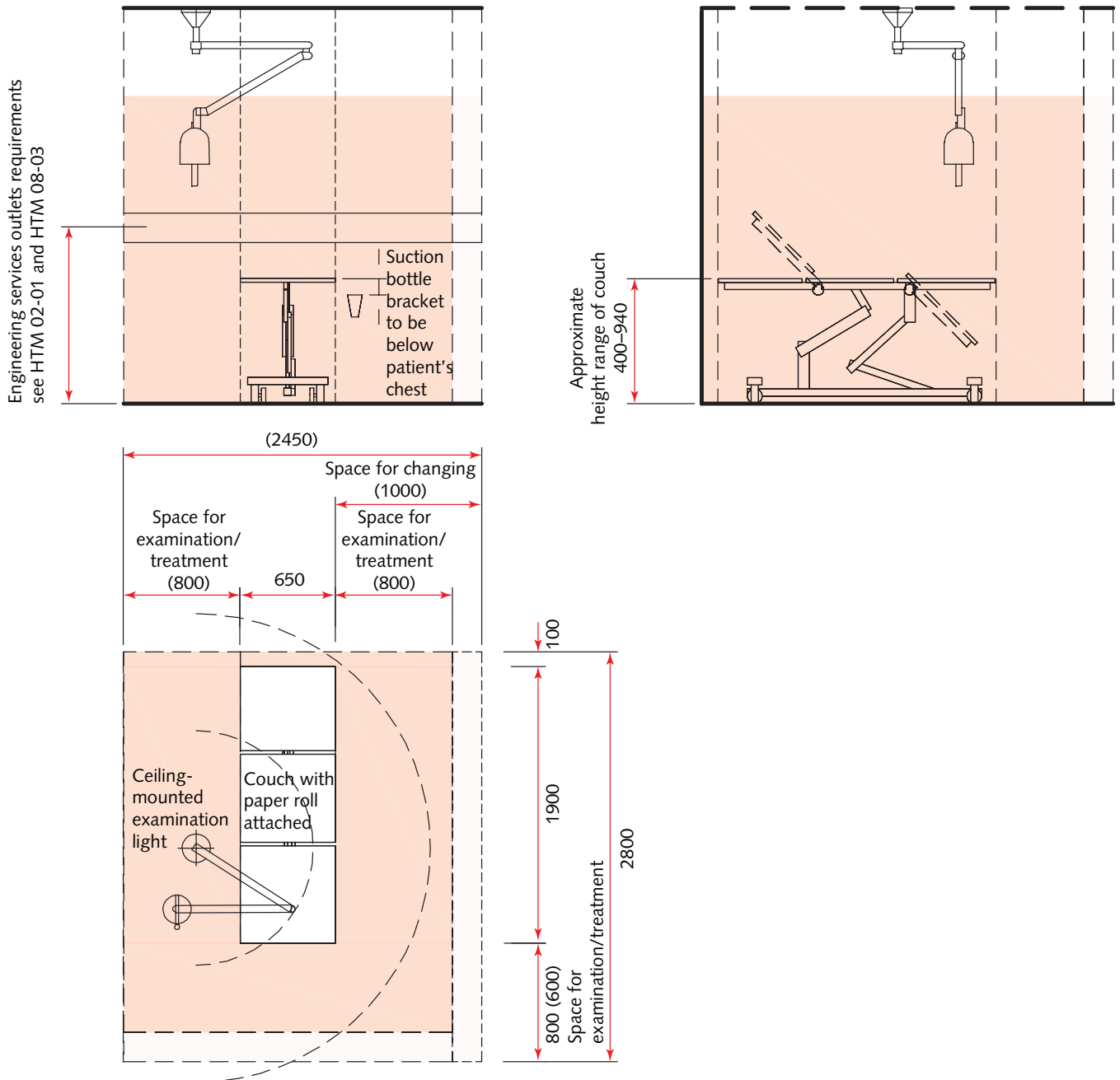

*Treatment chairs (various): double-sided access*

- 3.49 These ergonomic drawings (see Figure 13) show the space requirements for double-sided access to a variety of treatment chairs.
- 3.50 The reclining treatment/therapy chair provides the most flexible option for general examinations and treatments.
- 3.51 The reclining gynaecology chair may be used for general examinations and treatments or female internal examinations. A variety of attachments are available to assist internal examinations of females including stirrups, leg supports or footrests. The

use of the various methods is subject to local clinical and/or patient/ client preferences.

- 3.52 The podiatry treatment chair incorporates separate leg supports, which may be adjusted independently of one another.
- 3.53 The activity space for the podiatry treatment chair assumes the examination light is attached to the podiatry trolley. The illustrated chair is mobile. Floor-mounted chairs are also available although these may reduce flexibility in room use.

Figure 13 Space requirements for double-sided access to a variety of treatment chairs

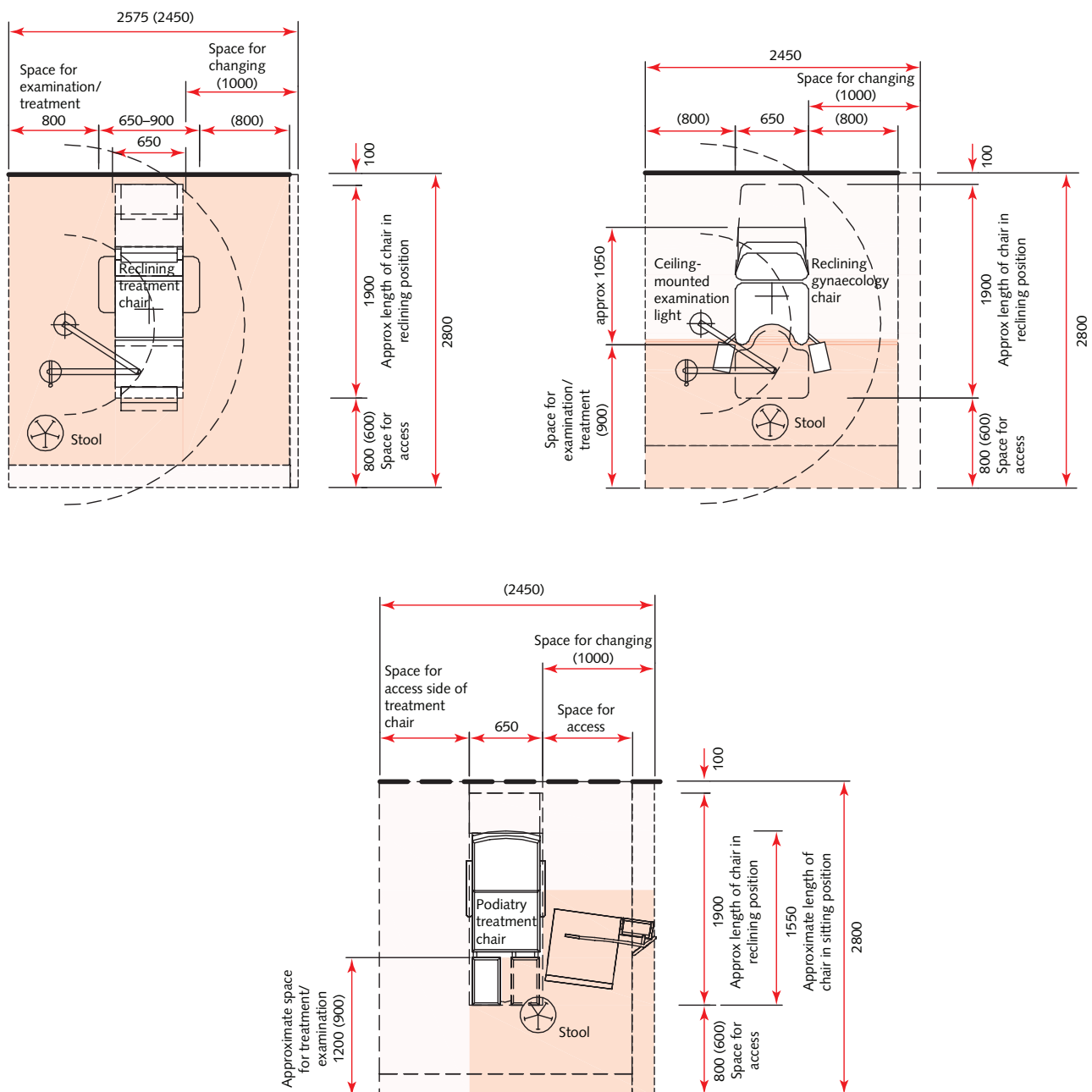

*Dressing and undressing: ambulant*

3.54 These ergonomic drawings (see Figure 14) show the space requirements for ambulant dressing and undressing.

3.55 An identical space provision is suitable for semi-ambulant users though it should be located adjacent to a seating area.

Figure 14 Space requirements for ambulant dressing and undressing

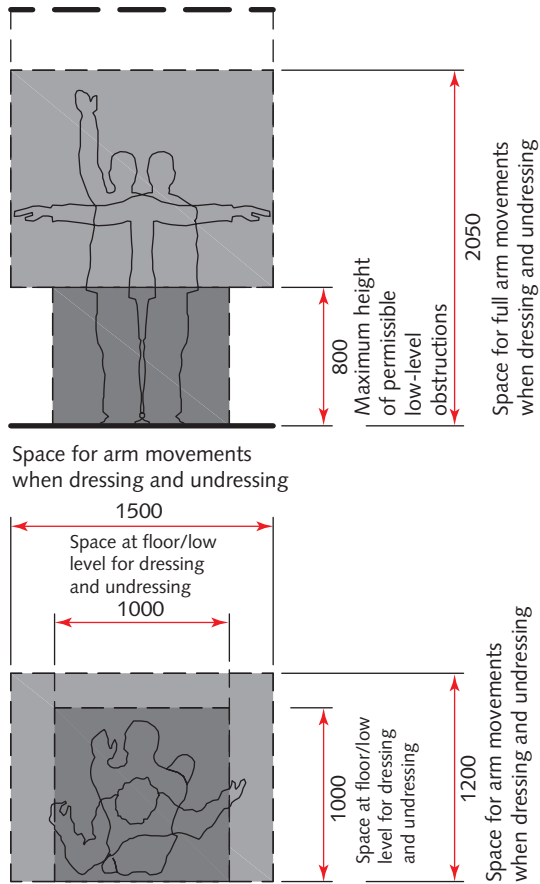



## Consulting/examination room: single-sided couch access

### Room description and layout

- 3.56 This room is intended as a flexible space for consultations and examinations for use by a wide range of specialties.
- 3.57 The following procedures may take place in this room:
- non-invasive procedures, that is, procedures that do not break the skin, for example changing a dressing;
  - minimally invasive procedures, that is, procedures that break or puncture the skin, for example injections, taking blood etc.
- 3.58 The room layout provided (see Figure 15) includes a two-section couch.
- 3.59 Where it is not necessary to access both sides of the couch, the single-sided room layout may be used but to maximise flexibility and adaptability double-sided couch access is generally recommended.

- 3.60 The layout shows the clinical wash-hand basin within the curtained examination area. However, its location should be subject to local policy and infection control advice. It must be easily accessible from both the consultation and examination areas. The curtain should be located to prevent it becoming contaminated from use of the clinical wash-hand basin.
- 3.61 Piped medical gases are generally not required. In emergency situations it is anticipated that bottled oxygen and mobile suction equipment will be readily available.
- 3.62 The room layout provided mean the patient/client will be positioned between the practitioner and the door during consultation. Consideration may be given to altering the layout to position the practitioner between the patient/client and the door for staff safety.
- 3.63 The layout has the disadvantage of the consultation area being located on the inside wall (that is, generally away from natural light) and the examination area being located on the outside wall (that is, requiring privacy control due to the likely proximity of a window).

Figure 15 Consulting/examination room, single-sided couch access

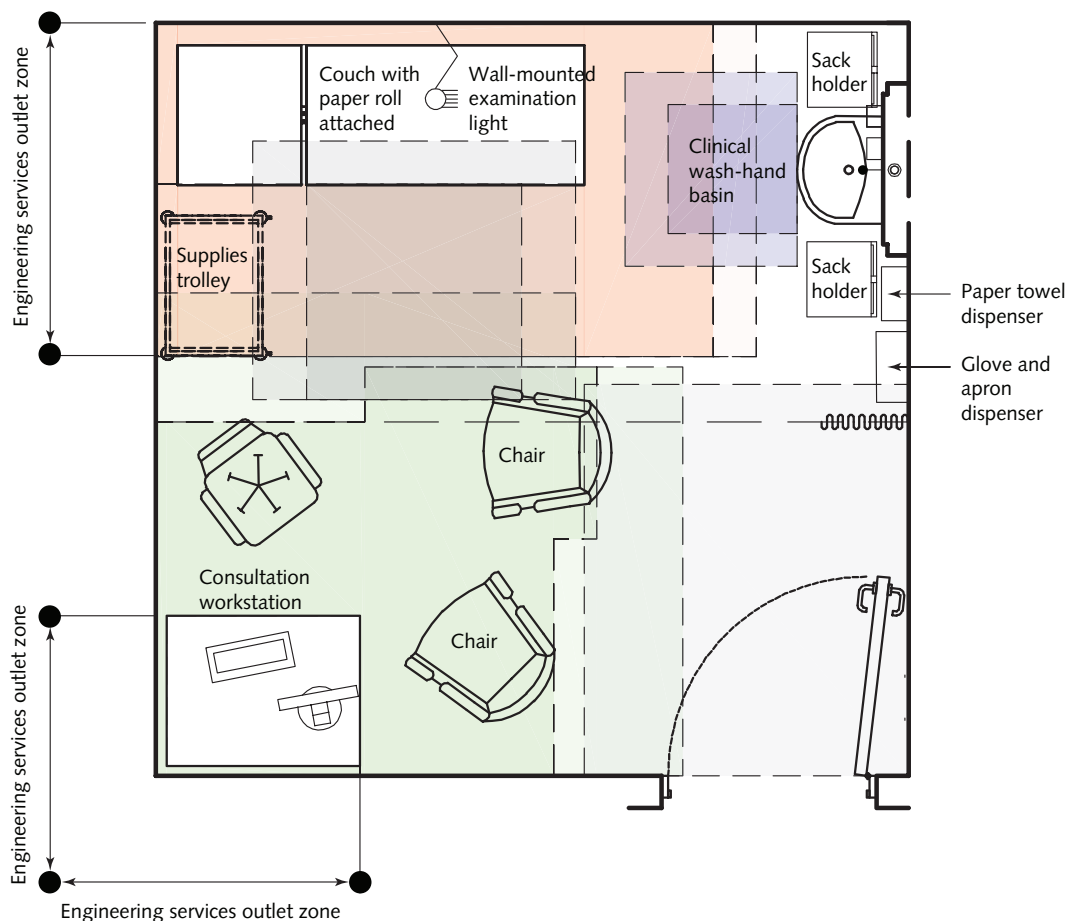

**Ergonomic drawings**

*Consultation workstation*

3.64 This ergonomic drawing (see Figure 16) shows a nominal space requirement for a consultation workstation. The actual space requirement will depend upon the design and location of the chairs and the design of the desk. The illustrated desk is the recommended minimum dimension for using a flat screen computer.

3.65 The activity space is based on the practitioner sitting at the desk with the patient/client seated diagonally opposite. The desk should not be located between the practitioner and patient/client.

3.66 It should be possible to rotate the computer monitor to allow the patient/client to view it.

3.67 The consultation desk should be positioned so that:

- the practitioner can acknowledge a patient/client on entry to the room;
- the practitioner is not be silhouetted against a window when in consultation with the patient/client.

3.68 A small lockable drawer should be available to store prescription pads if electronic prescriptions are not being used.

3.69 A small local printer may be provided.

Figure 16 Nominal space requirement for a consultation workstation

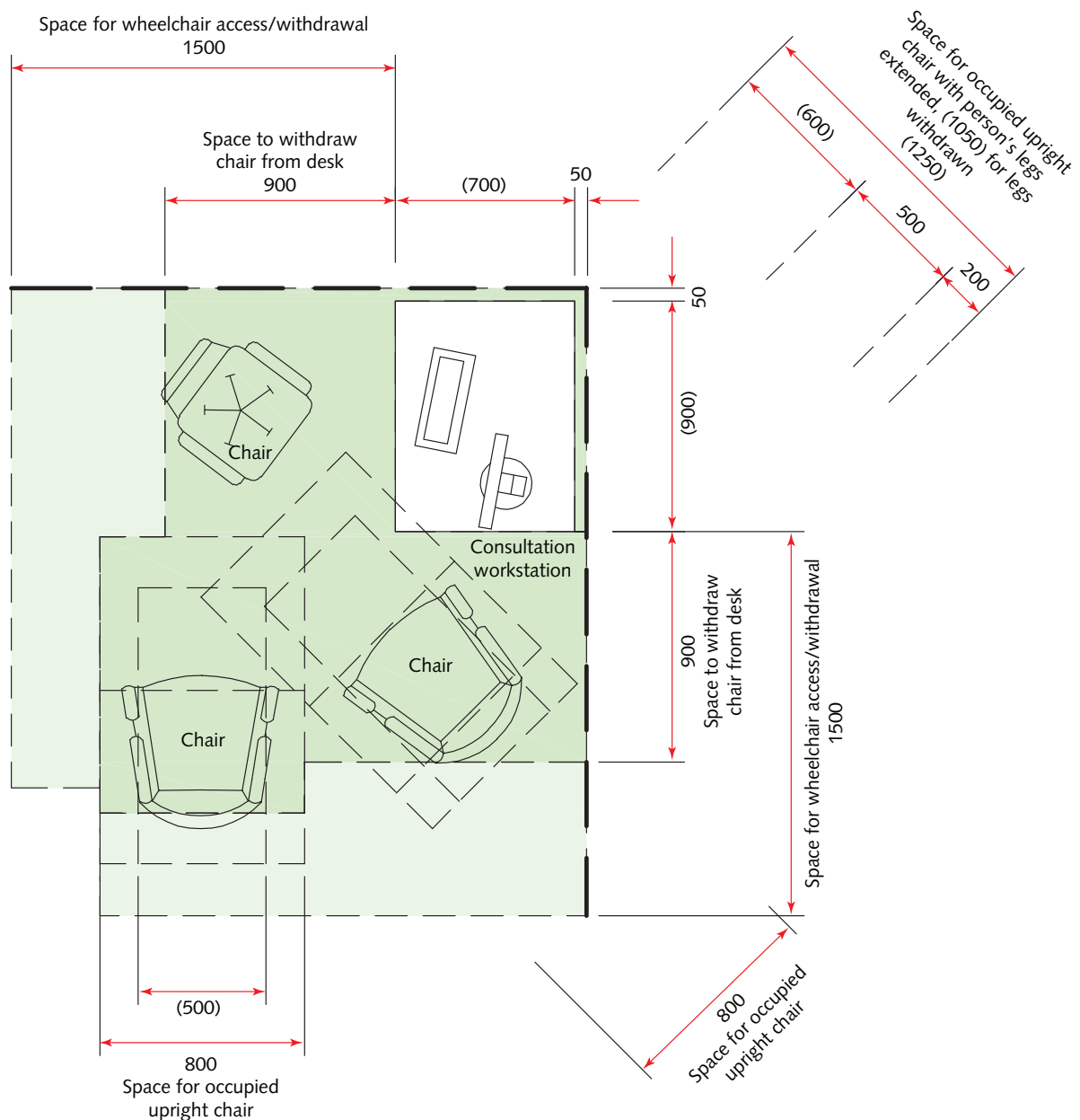

*Clinical wash-hand basin*

3.70 These ergonomic drawings (see Figure 17) show the space requirements for standing use of a clinical wash-hand basin assembly. For seated use, the basin will need to be lowered.

3.71 The basin should be fitted with non-touch taps.

3.72 The recommended fixing height of a lever tap on a clinical wash-hand basin is 1095 mm. Where a lever tap is used, the fixing height of the dispensers should be chosen to reduce any possible conflicts in use.

3.73 The illustrated clinical wash-hand basin projects 400 mm from the back panel or wall. However, clinical wash-hand basins may vary from 350 to 500 mm projection. Where basins deeper than 400 mm are used, the impact on/from other components and/or activities undertaken within any space should be considered when evaluating any room layout.

3.74 The glove and apron dispenser illustrated is a combined unit; this is considered the most compact solution although separate units may also be used. Even the most compact unit cannot practically be located within comfortable reach of the basin; it should, however, be conveniently located within the room.

3.75 The ergonomic advice for the height of horizontal elbow operated lever taps is based on the following data:

“Elbow height for shod, slightly bent posture (as when leaning forward) for 50%ile UK male = 1134 mm, for female 1049 mm. 1090 mm is considered the best compromise for an elbow height for both male and female use. The ergonomic advice for the height of a lever tap is 75 mm below elbow height giving a figure height of approx 1015 mm.”

3.76 Lever taps are not illustrated.

3.77 For detailed information on basins, see Health Building Note 00-10 Part C – ‘Sanitary assemblies’.

Figure 17 Space requirements for standing use of a clinical wash-hand basin assembly

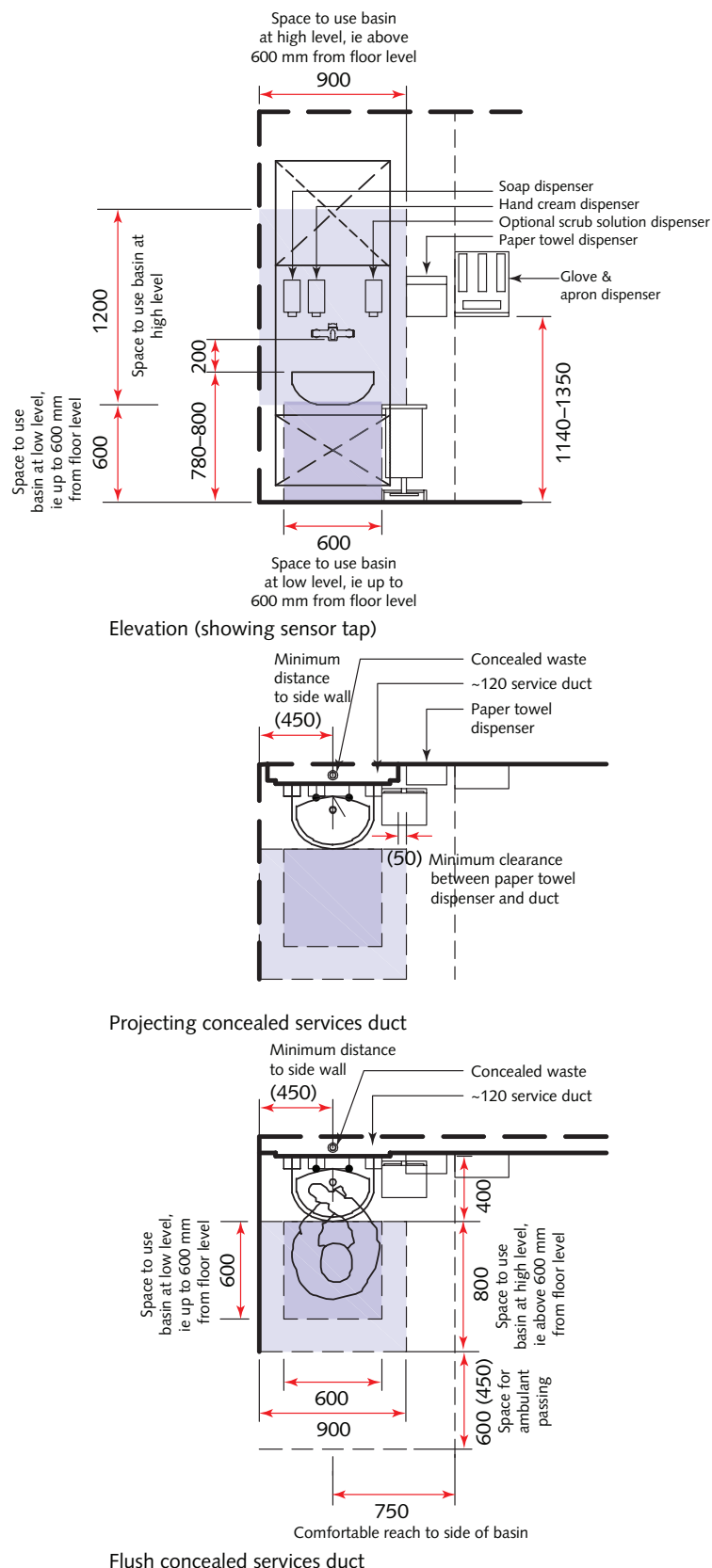

*Couch: single-sided access*

3.78 This ergonomic drawing (see Figure 18) shows the space requirements for single-sided access to a couch. It illustrates a two-section couch simply as the most likely scenario. The generic access space is believed to be the same for other types of couch.

3.79 Wall-mounted examination lights should be provided where single-sided couch access is required. The light may be mounted on a horizontal rail to enable its position to be altered in the horizontal plane.

Figure 18 Space requirements for single-sided access to a couch

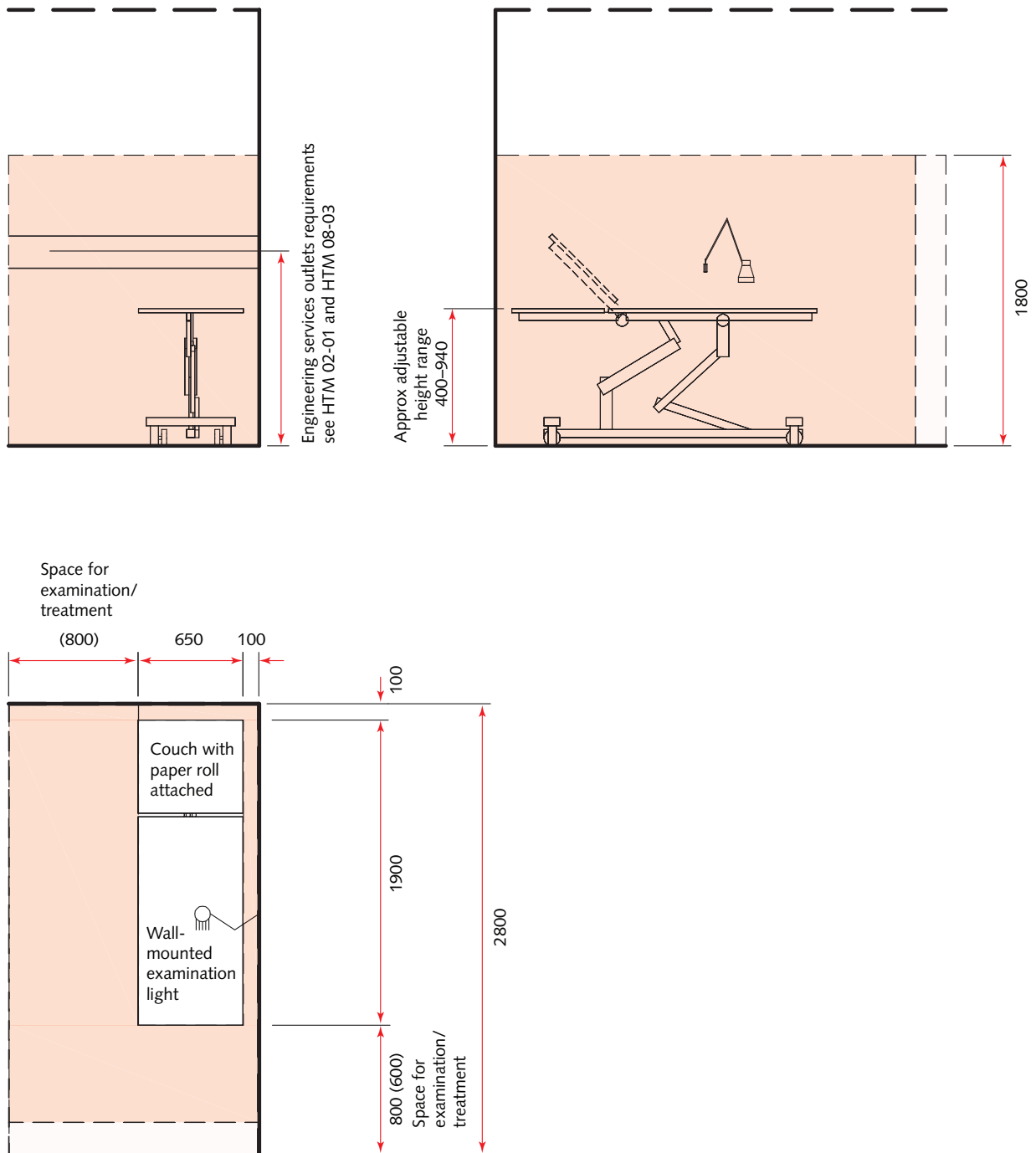

*Dressing and undressing: ambulant*

3.80 These ergonomic drawings (see Figure 19) show the space requirements for ambulant dressing and undressing.

3.81 An identical space provision is suitable for semi-ambulant users though it should be located adjacent to a seating area.

Figure 19 Space requirements for ambulant dressing and undressing

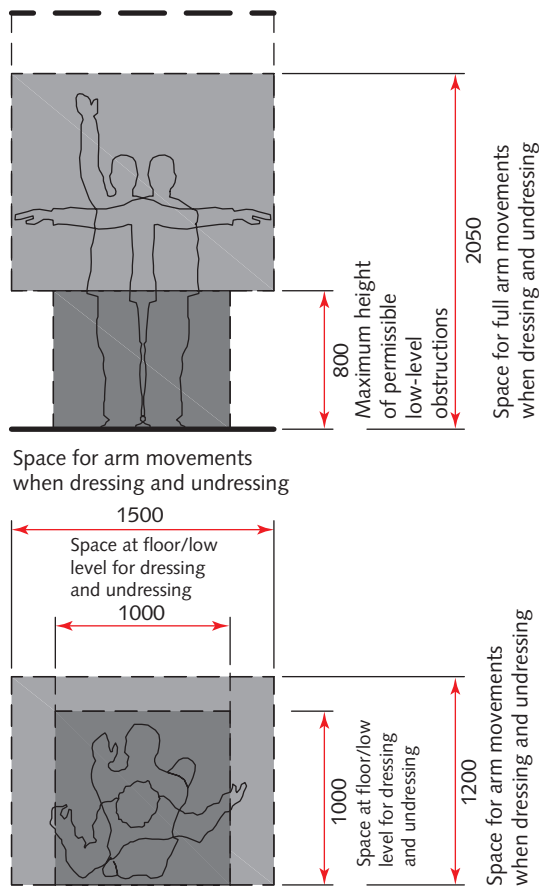

## Examination/physical therapy room

### Room description and layout

3.82 An examination/physical therapy space is intended as a generic space where a variety of examinations, tests and therapies (for example physiotherapy, acupuncture and massage) may be undertaken.

3.83 The following procedures may take place in this room:

- non-invasive procedures, i.e. procedures that do not break the skin, for example changing a dressing;
- minimally invasive procedures, i.e. procedures that break or puncture the skin, for example injections, taking blood etc.

3.84 It has been sized to accommodate mobile diagnostic equipment, for example mobile ultrasound equipment.

3.85 The room layout provided (see Figure 20) includes a standard three-section couch. However, for maximum flexibility, of general use, a reclining treatment/therapy chair that supports patient/client in sitting or supine position is recommended.

3.86 Alternatively, the room can accommodate a reclining gynaecology chair or bobath plinth (for physiotherapy treatments) although the clinical workstation would conflict fractionally with the space required around the plinth.

3.87 A touchdown base may be located nearby in place of the clinical workstation in the room.

3.88 Where trolley access is required, a door and a half in a 1500 mm aperture will be required.

3.89 Locating the privacy curtain across the width of the room will allow an attendant to wait outside the examination area.

Figure 20 Examination/physical therapy room

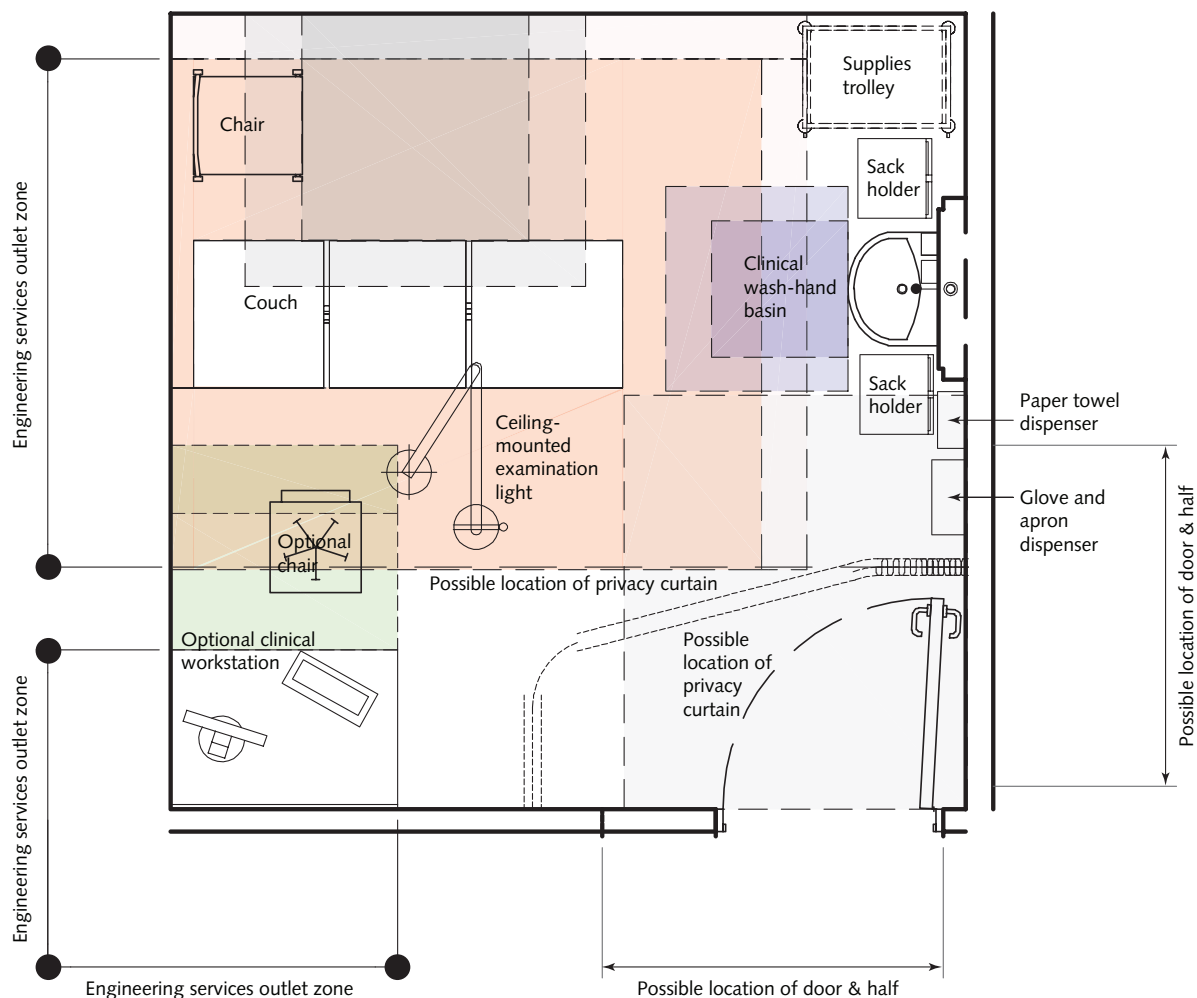

### Separate versus combined consulting and examination rooms

- 3.90 Separate consulting and examination rooms may be justified for some clinics. However, they do not provide the flexibility of combined consulting/examination rooms. See Figure 21.
- 3.91 Where separate consulting and examination rooms are provided, there should not be adjoining doors between the rooms for reasons of patient privacy.
- 3.92 A comparison of the space requirements and utilisation of four combined consulting/examination rooms against two consulting rooms and four examination rooms shows the combined rooms require less space and offer greater utilisation.

Figure 21 Combined versus separate consulting and examination rooms

Example 1: 4 Consulting/examination rooms (@ 16 m<sup>2</sup>)

Range of uses:  
1–4 doctors  
1–4 clinic sessions

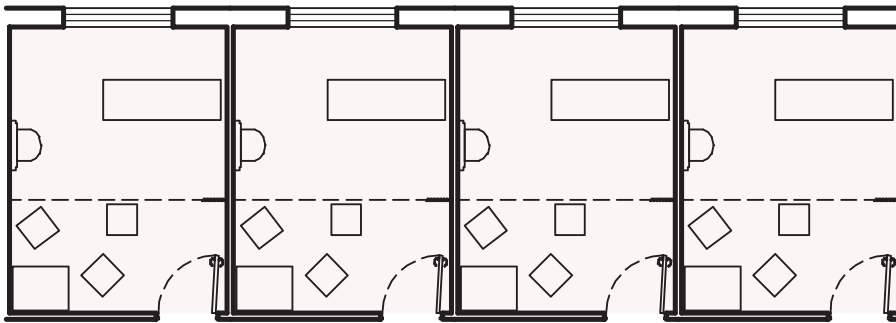

Example 2: 2 Consulting and 4 examination rooms (@ 12 m<sup>2</sup>)

Range of uses:  
1–2 doctors  
1–2 clinic sessions

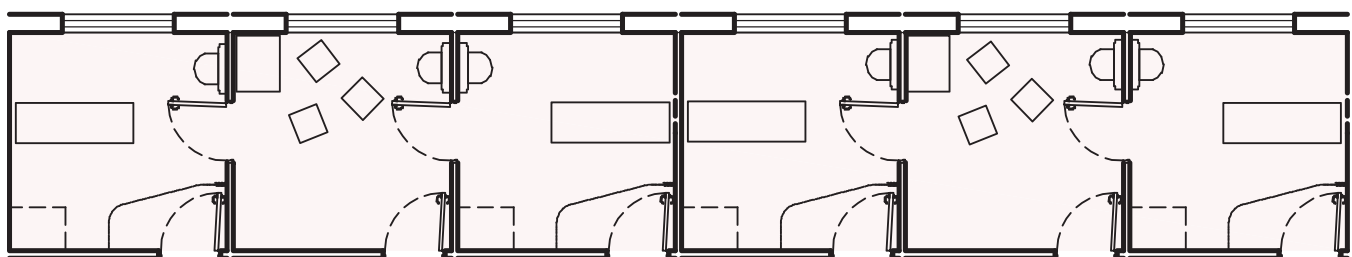

**Ergonomic drawings**

*Clinical workstation*

3.93 This ergonomic drawing (see Figure 22) shows the space requirements for a clinical workstation.

3.94 The clinical workstation is intended for accessing and updating patient records within a clinical environment. It should only be used for short periods of time.

Figure 22 Space requirements for a clinical workstation

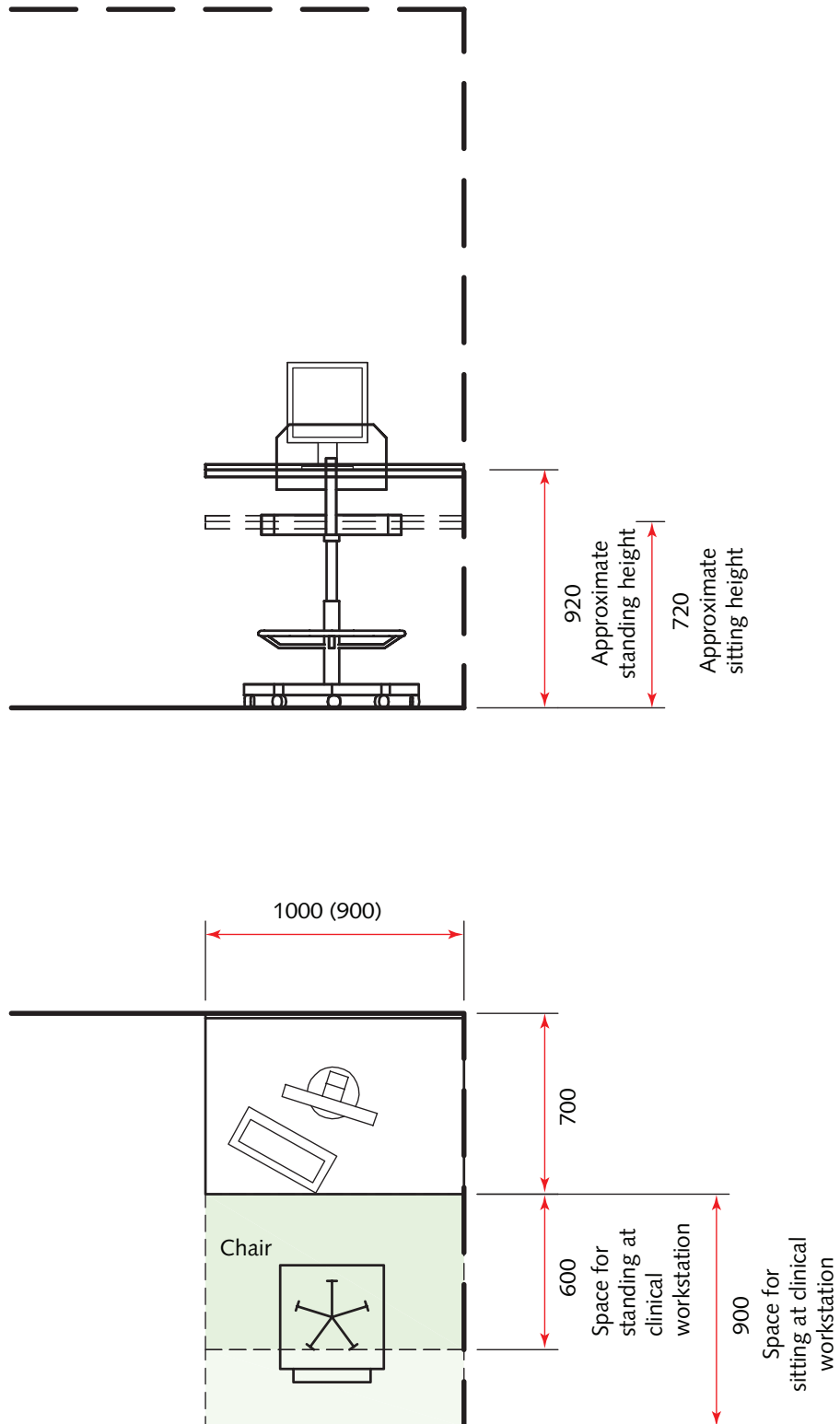



*Clinical wash-hand basin*

3.95 These ergonomic drawings (see Figure 23) show the space requirements for standing use of a clinical wash-hand basin assembly. For seated use, the basin will need to be lowered.

3.96 The basin should be fitted with non-touch taps.

3.97 The recommended fixing height of a lever tap on a clinical wash-hand basin is 1095 mm. Where a lever tap is used, the fixing height of the dispensers should be chosen to reduce any possible conflicts in use.

3.98 The illustrated clinical wash-hand basin projects 400 mm from the back panel or wall. However, clinical wash-hand basins may vary from 350 to 500 mm projection. Where basins deeper than 400 mm are used, the impact on/from other components and/or activities undertaken within any space should be considered when evaluating any room layout.

3.99 The glove and apron dispenser illustrated is a combined unit; this is considered the most compact solution although separate units may also be used. Even the most compact unit cannot practically be located within comfortable reach of the basin; it should, however, be conveniently located within the room.

3.100 The ergonomic advice for the height of horizontal elbow operated lever taps is based on the following data:

“Elbow height for shod, slightly bent posture (as when leaning forward) for 50%ile UK male = 1134 mm, for female 1049 mm. 1090 mm is considered the best compromise for an elbow height for both male and female use. The ergonomic advice for the height of a lever tap is 75 mm below elbow height giving a figure height of approx 1015 mm.”

3.101 Lever taps are not illustrated.

3.102 For detailed information on basins, see Health Building Note 00-10 Part C – ‘Sanitary assemblies’.

Figure 23 Space requirements for standing use of a clinical wash-hand basin assembly

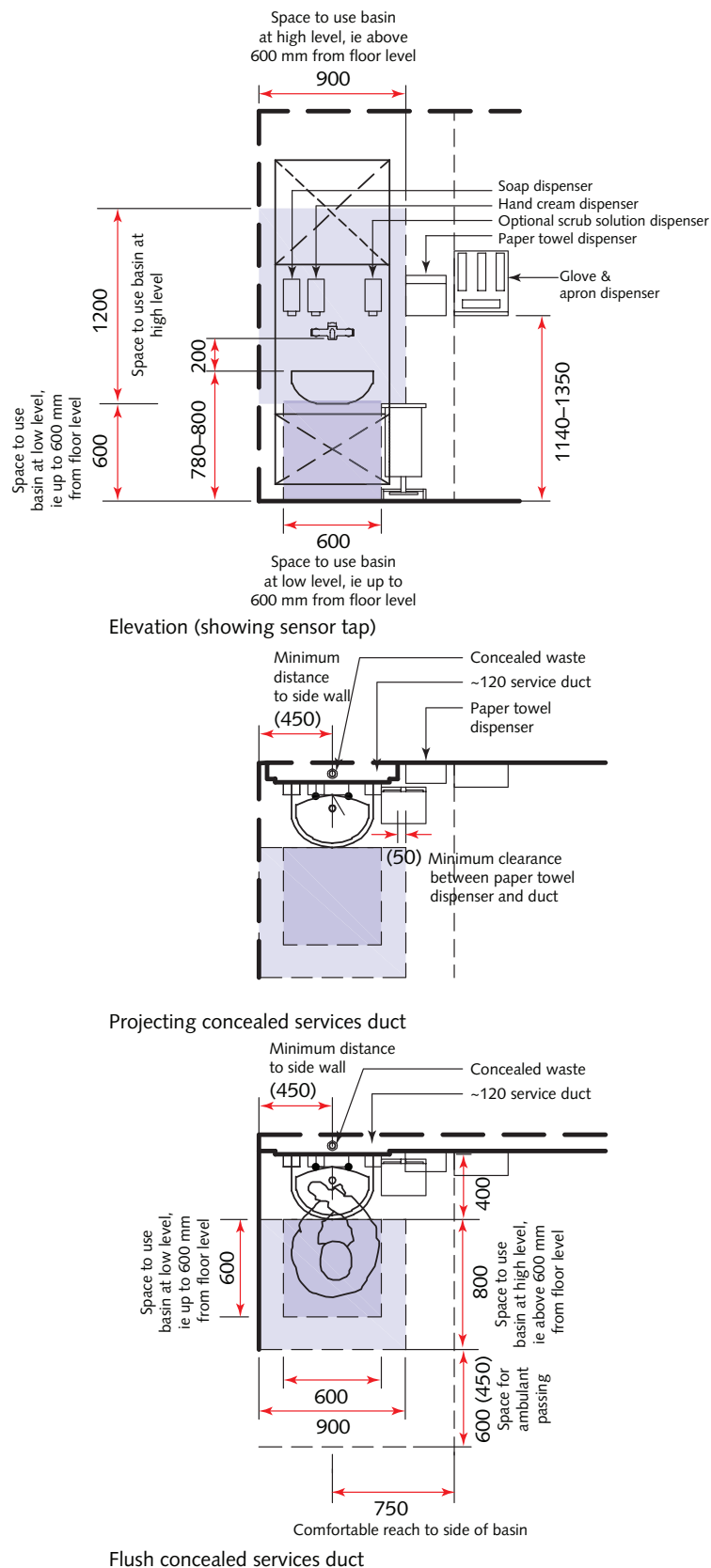

*Couch: double-sided access*

3.103 These ergonomic drawings (see Figure 24) show the space requirements for double-sided access to a three-section couch. The overall general space requirements for a three-section couch are the same as for a two-section couch.

3.104 Ceiling-mounted examination lights should be provided where double-sided couch access is required.

Figure 24 Space requirements for double-sided access to a three-section couch

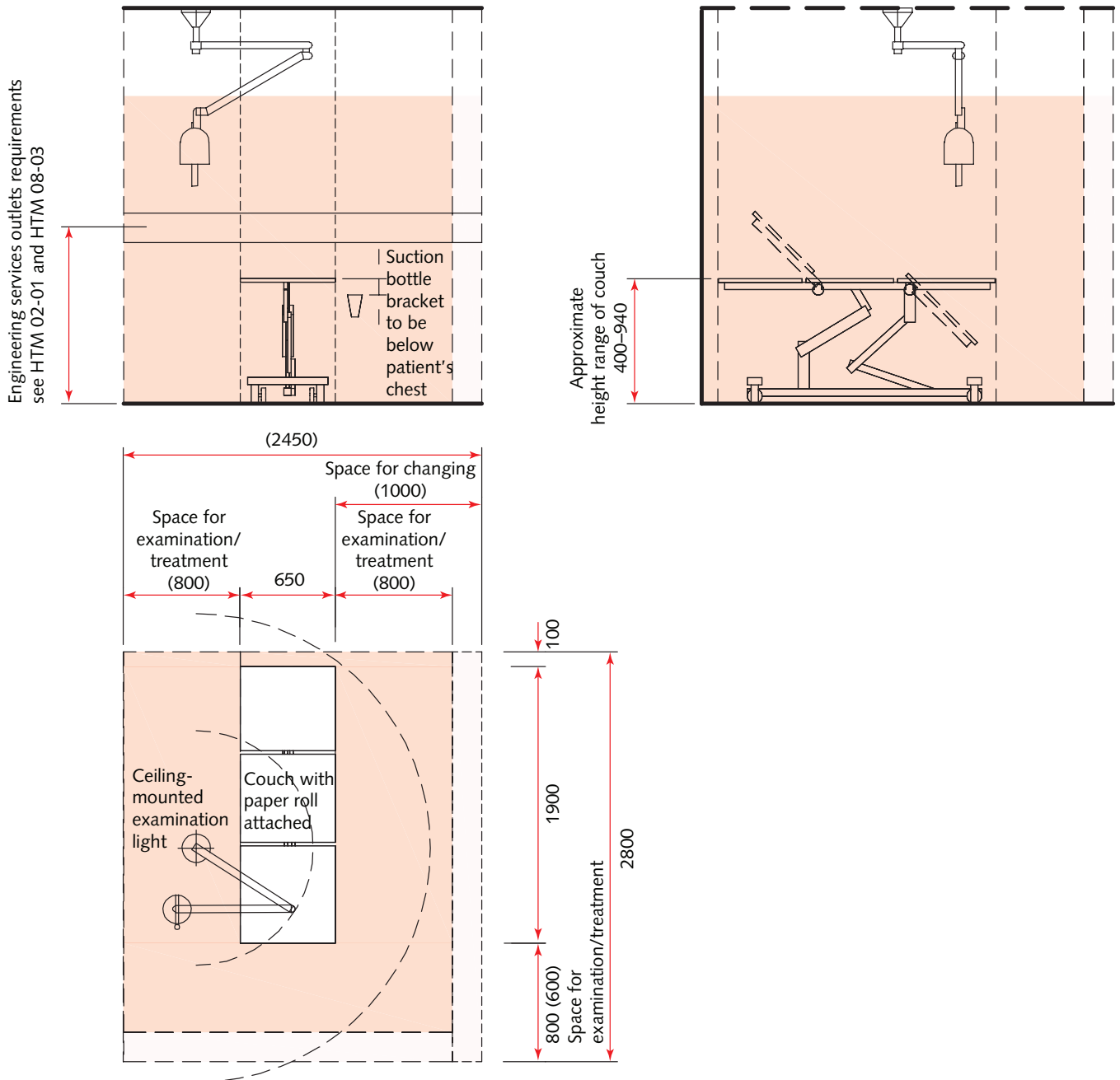

*Treatment chairs (various): double-sided access*

3.105 These ergonomic drawings (see Figure 25) show the space requirements for double-sided access to a variety of treatment chairs.

3.106 The reclining treatment/therapy chair provides the most flexible option for general examinations and treatments.

3.107 The reclining gynaecology chair may be used for general examinations and treatments or female internal examinations. A variety of attachments are available to assist internal examinations of females

including stirrups, leg supports or footrests. The use of the various methods is subject to local clinical and/or patient/client preferences.

3.108 The podiatry treatment chair incorporates separate leg supports, which may be adjusted independently of one another.

3.109 The activity space for the podiatry treatment chair assumes the examination light is attached to the podiatry trolley. The illustrated chair is mobile. Floor-mounted chairs are also available although these may reduce flexibility in room use.

Figure 25 Space requirements for double-sided access to a variety of treatment chairs

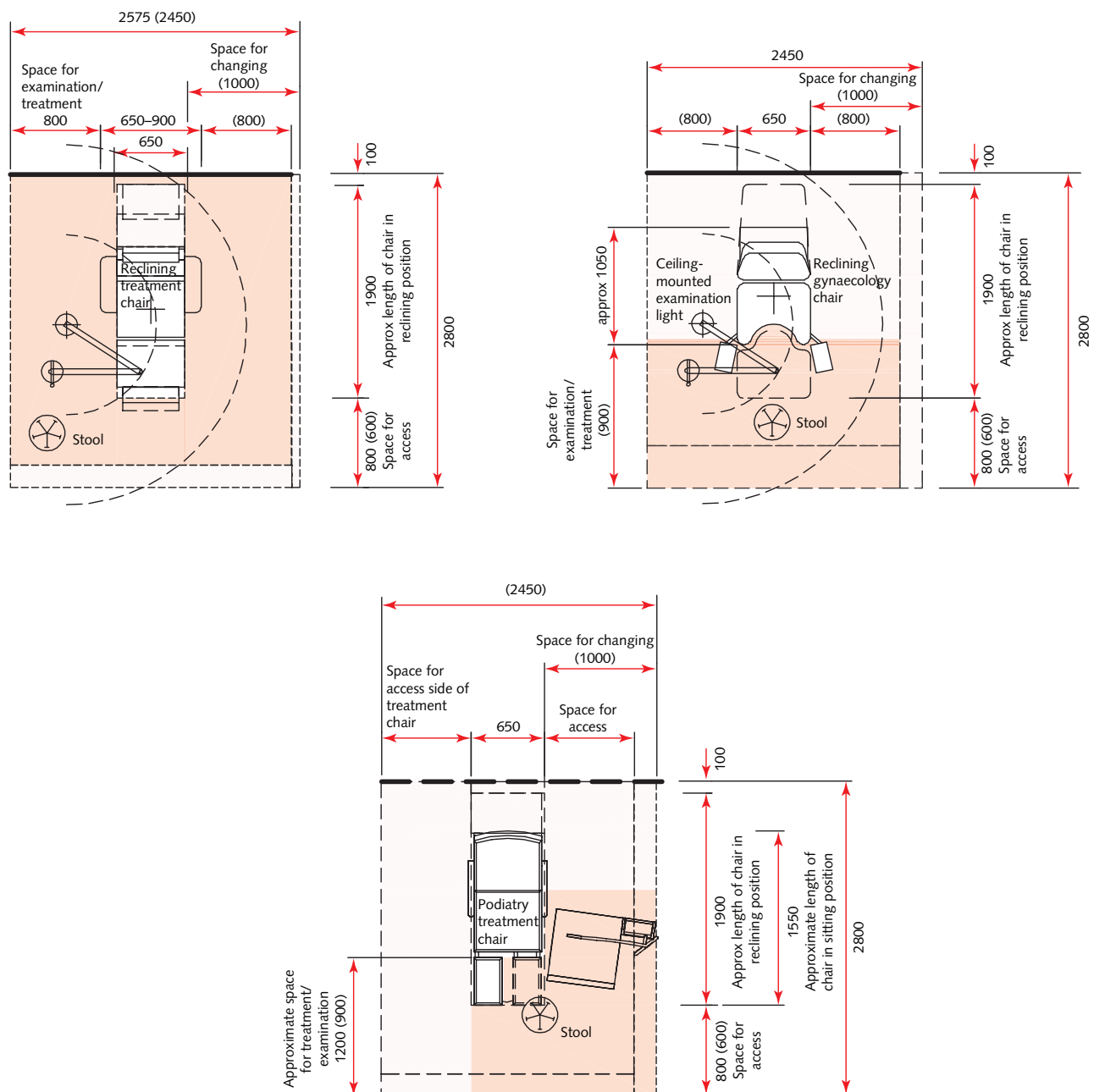

*Bobath plinth*

3.110 The ergonomic drawing (see Figure 26) shows the space requirements for doublesided access to a two-section bobath plinth.

Figure 26 Bobath plinth: double-sided access

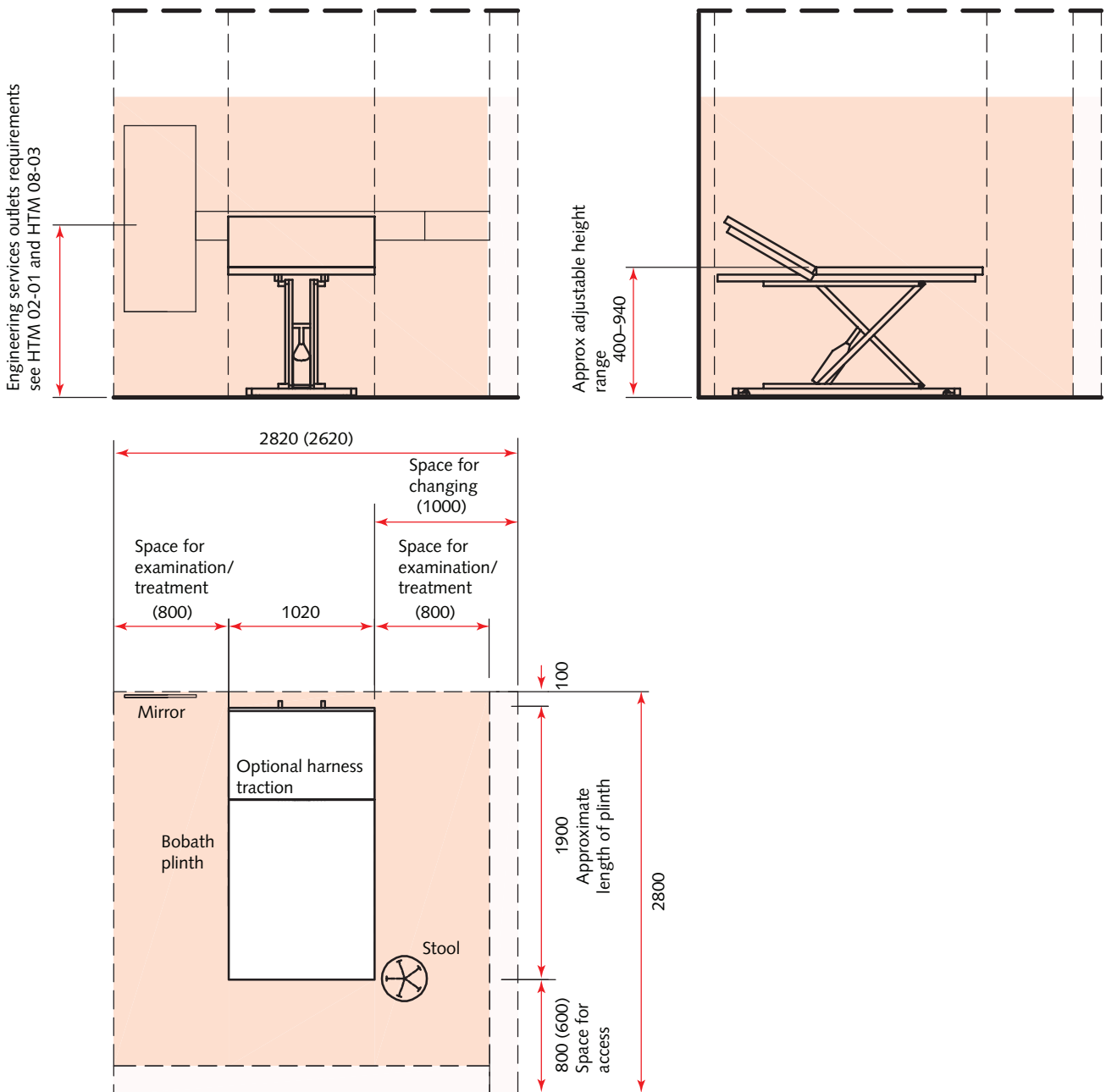

## Interview room: 4 places

### Room description and layout

- 3.111 A generic interview room may be used for general discussions, interviews and counselling. It may also be used as a sitting room for relatives or patients/clients. See Figure 27.
- 3.112 A non-threatening ambience should be created through the use of domestic type furniture, for

example sofas and easy chairs. All upholstered furniture must be easy to clean and impervious.

- 3.113 Telephone and network/internet access should be provided to allow for future change of use.
- 3.114 A clinical wash-hand basin and gel dispenser may be provided to allow for clinical use of the room.
- 3.115 The illustrated space requirements for sitting on a sofa are based on space to access a divan bed.

Figure 27 Interview room: 4 places

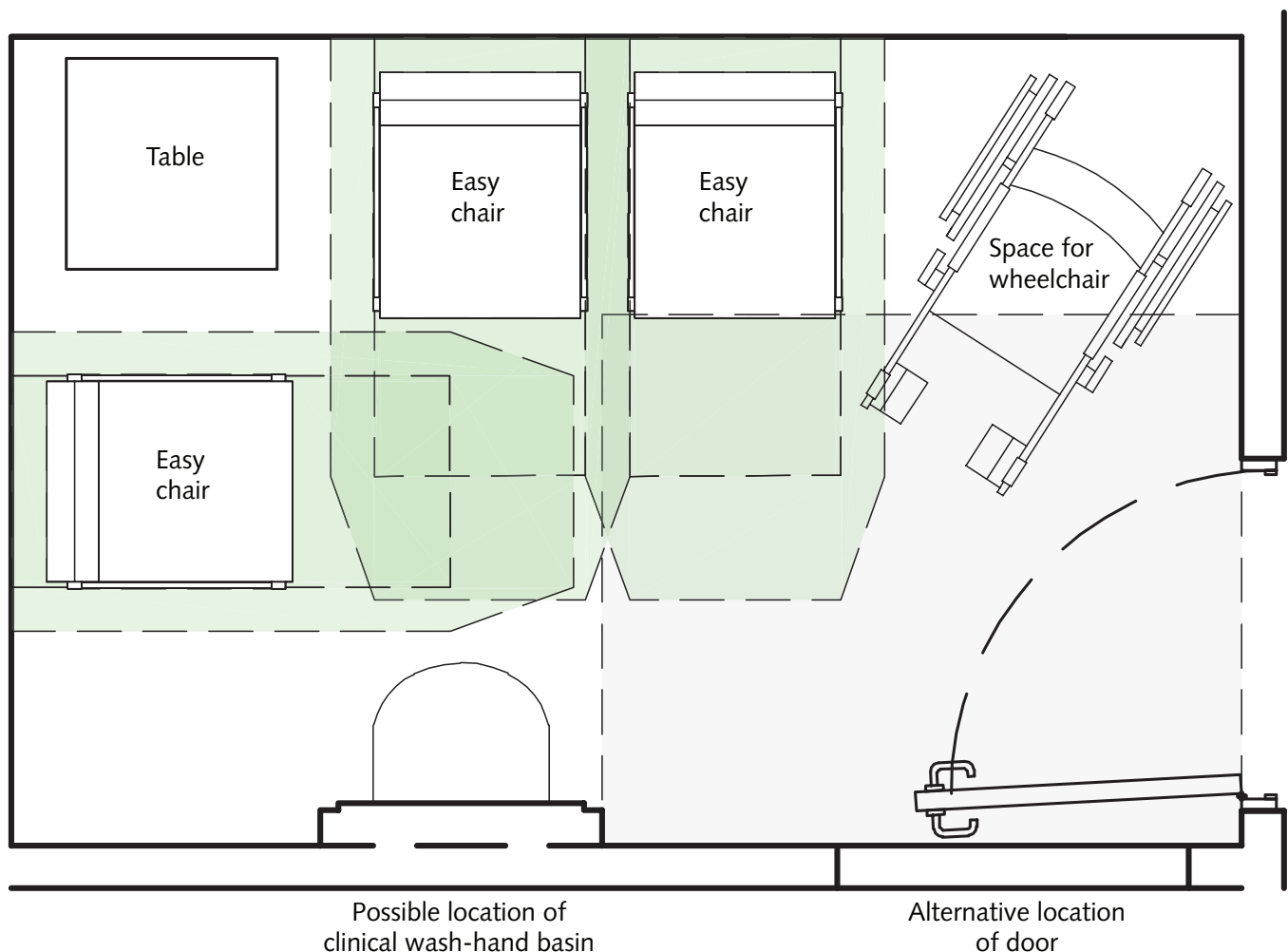

**Ergonomic drawings**

*Space to sit on an easy chair*

3.116 These ergonomic drawings (see Figure 28) show the space requirements for a person to sit on an easy chair.

3.117 When seats are pushed together in rows, the average seat width is 600–650 mm for seats without arms and 750 mm for seats with arms.

Figure 28 Space requirements to sit on an easy chair

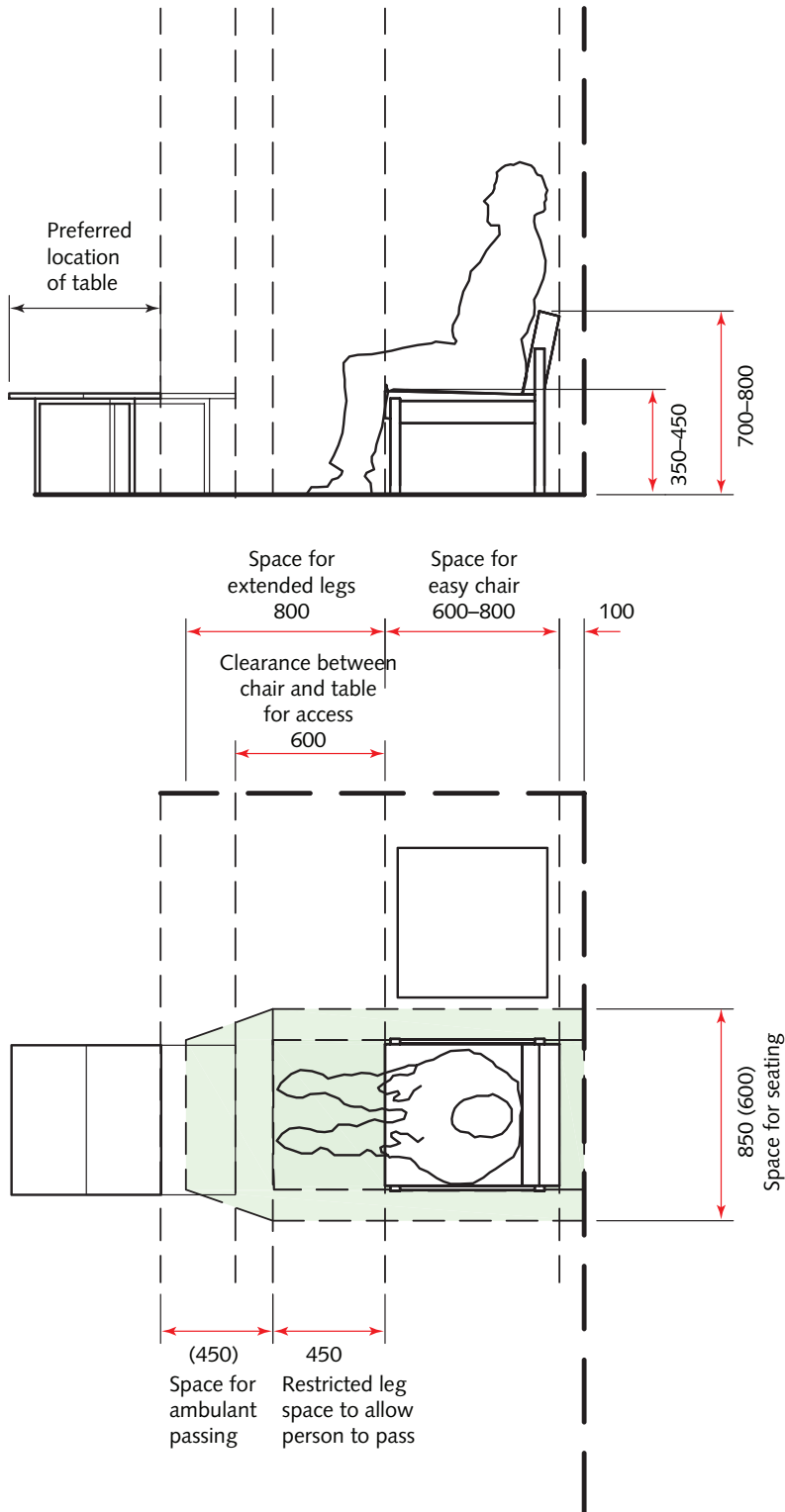

*Space to access a divan bed*

3.118 This ergonomic drawing (see Figure 29) shows the space requirements for wheelchair and ambulant access to a divan bed.

Figure 29 Space requirements for wheelchair and ambulant access to a divan bed

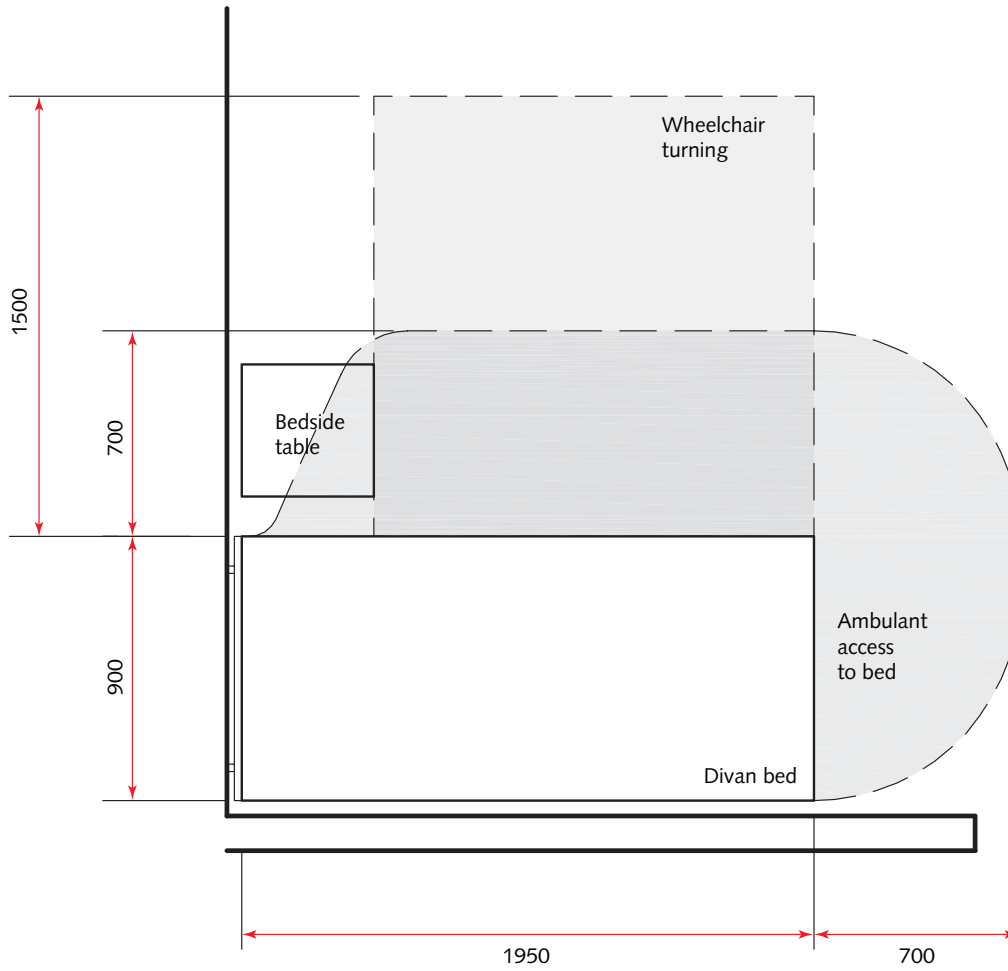

## Interview room: 7 places

### Room description and layout

- 3.119 A generic interview room may be used for general discussions, interviews and counselling. It may also be used as a sitting room for relatives or patients/clients. See Figure 30.
- 3.120 A non-threatening ambience should be created through the use of domestic type furniture, for example sofas and easy chairs. All upholstered furniture must be easy to clean and impervious.

- 3.121 Telephone and network/internet access should be provided to allow for future change of use.
- 3.122 A clinical wash-hand basin and gel dispenser may be provided to allow for clinical use of the room.
- 3.123 A 7-place (rather than 4-place) interview room is generally recommended for reasons of flexibility and adaptability.
- 3.124 The illustrated space requirements for sitting on a sofa are based on space to access a divan bed.

Figure 30 Interview room: 7 places including 1 wheelchair place

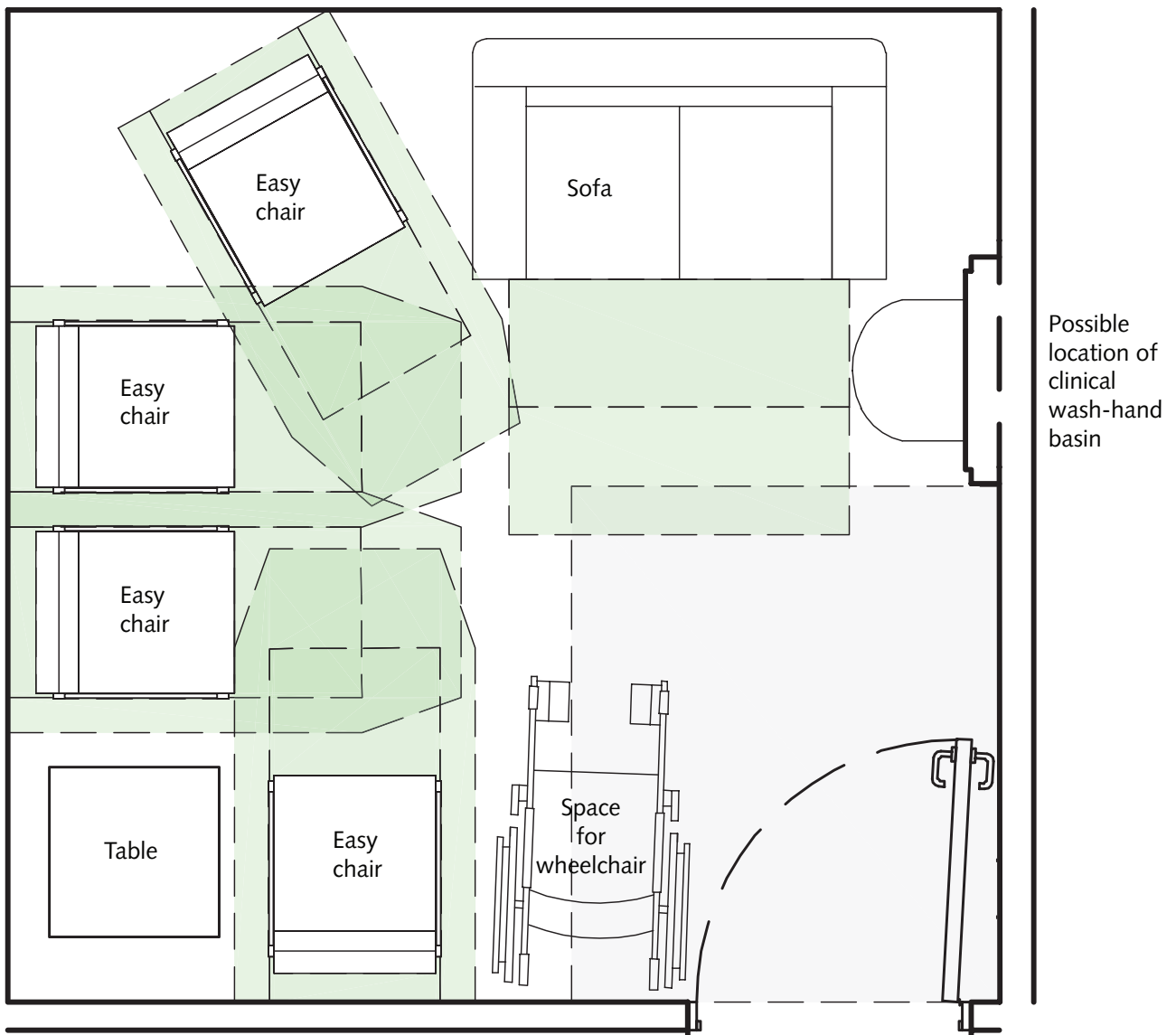



**Ergonomic drawings**

*Space to sit on an easy chair*

3.125 These ergonomic drawings (see Figure 31) show the space requirements for a person to sit on an easy chair.

3.126 When seats are pushed together in rows, the average seat width is 600–650 mm for seats without arms and 750 mm for seats with arms.

Figure 31 Space requirements to sit on an easy chair

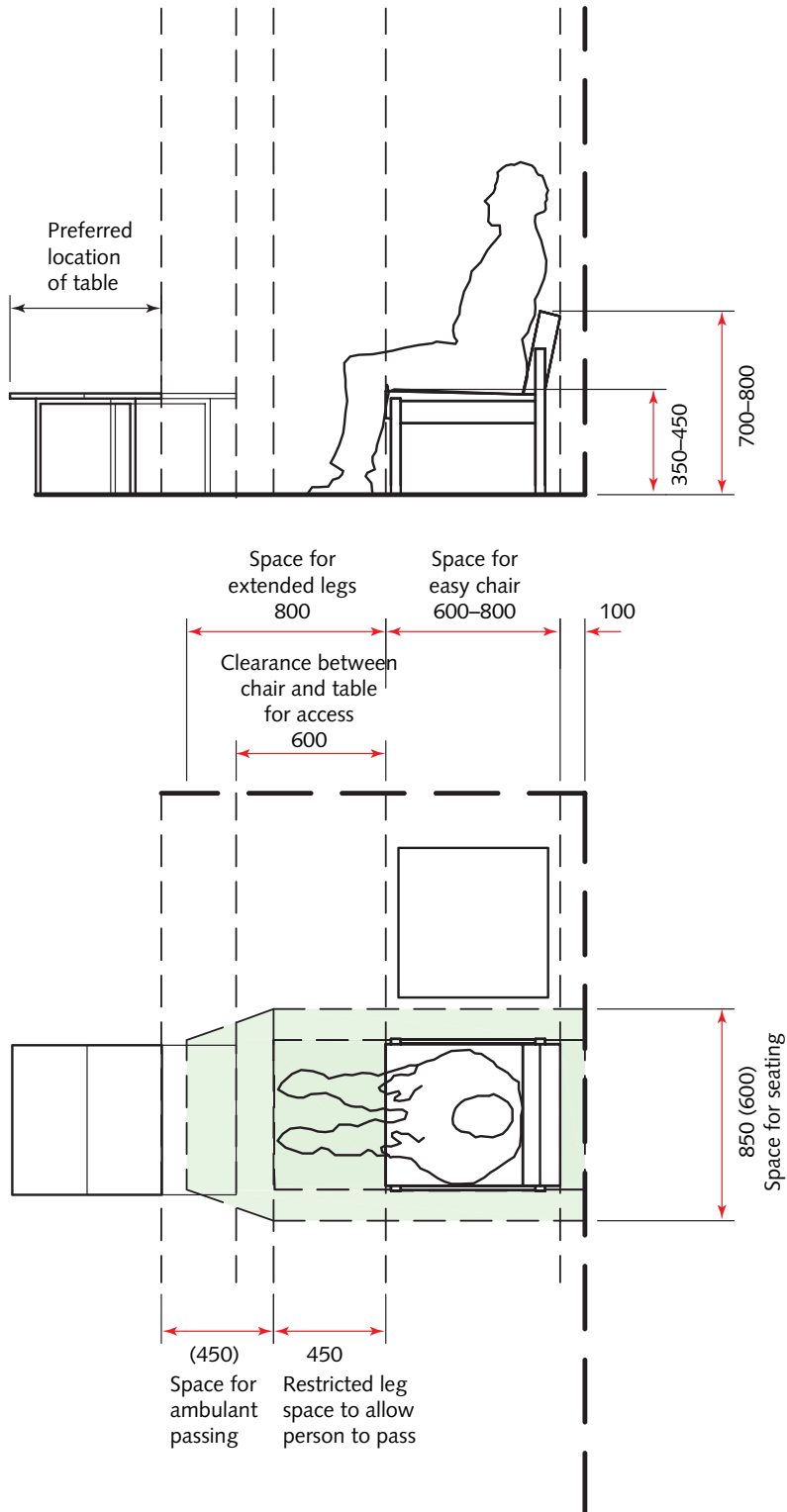

*Space to access a divan bed*

3.127 This ergonomic drawing (see Figure 32) shows the space requirements for wheelchair and ambulant access to a divan bed.

Figure 32 Space requirements for wheelchair and ambulant access to a divan bed

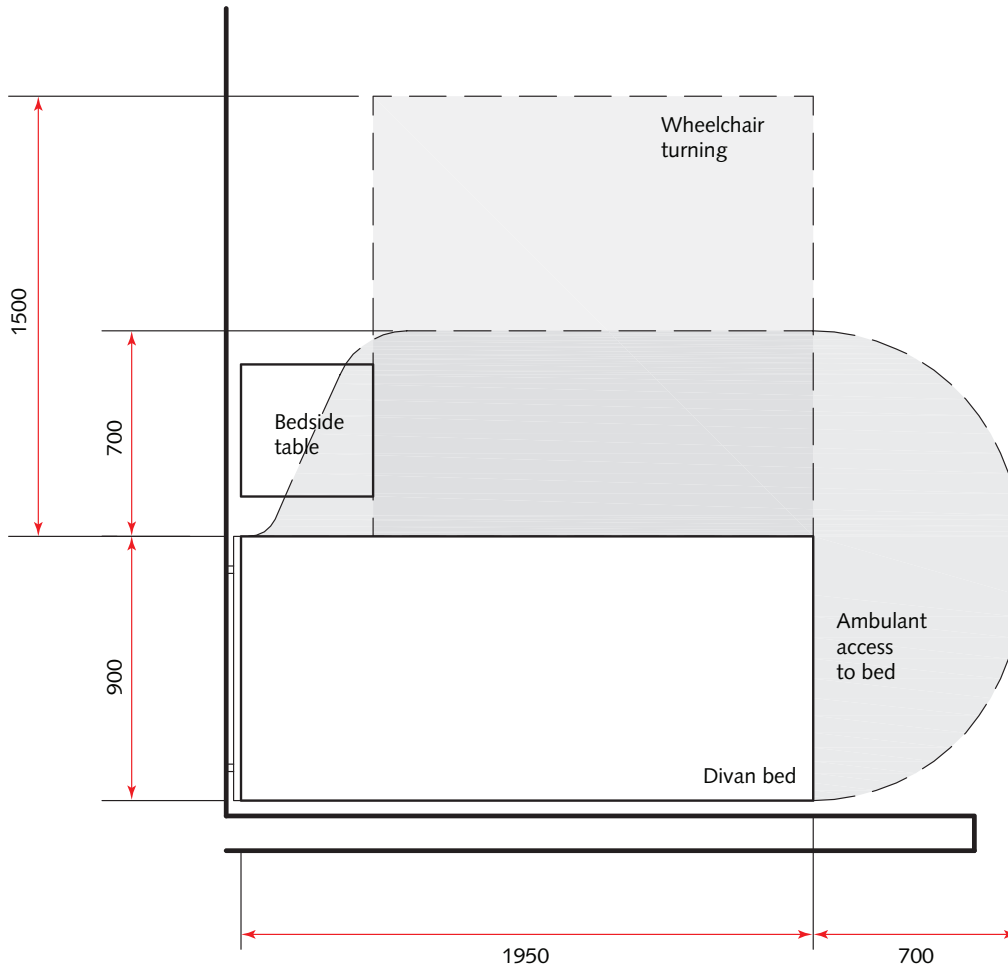

## 4 Generic clinical spaces: Group rooms

### Free movement exercise room

#### Room description and layout

4.1 The room layout provided (see Figure 33) shows a 32 m<sup>2</sup> group room furnished for mat-based exercise activities. The layout includes three large mats, each 1800 mm × 1000 mm, and four standard mats, each 1800 mm × 600 mm.

4.2 For sizing exercise rooms, the following allowances may be used:

- 2–4 m<sup>2</sup> per practitioner;
- 4.5 m<sup>2</sup> per large mat or 3.5 m<sup>2</sup> per standard mat.

Figure 33 Free movement exercise room

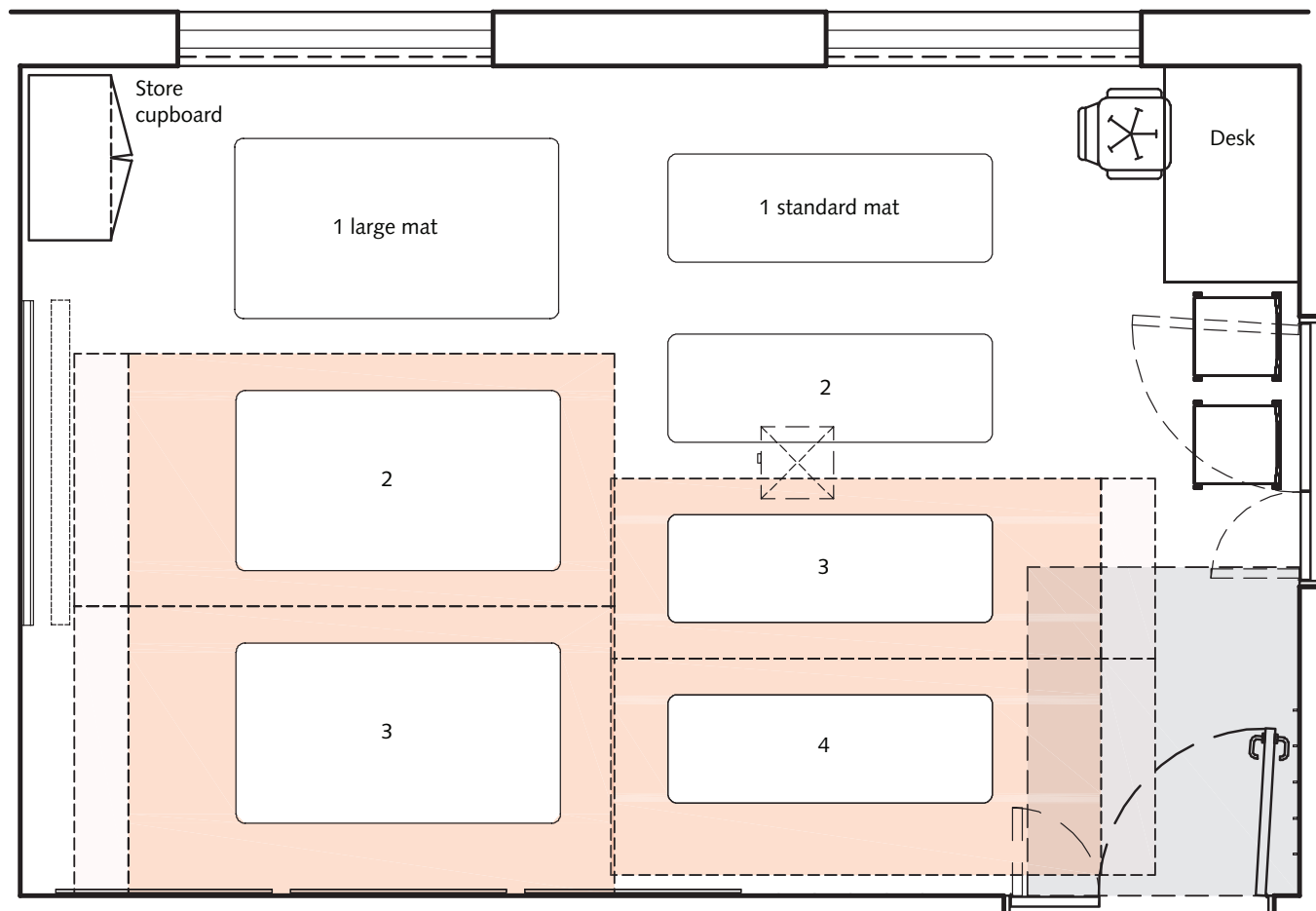

**Ergonomic drawings**

*Exercise mats*

4.3 This drawing (see Figure 34) illustrates two mat sizes with associated space for passing between two mats.

4.4 Typically the standard mats are used for exercise classes (yoga, pilates etc). The larger mat relates to the standard size of a small birthing mat and should be sufficient for antenatal classes.

4.5 This space has not been defined by specific ergonomic research.

Figure 34 Space between exercise mats

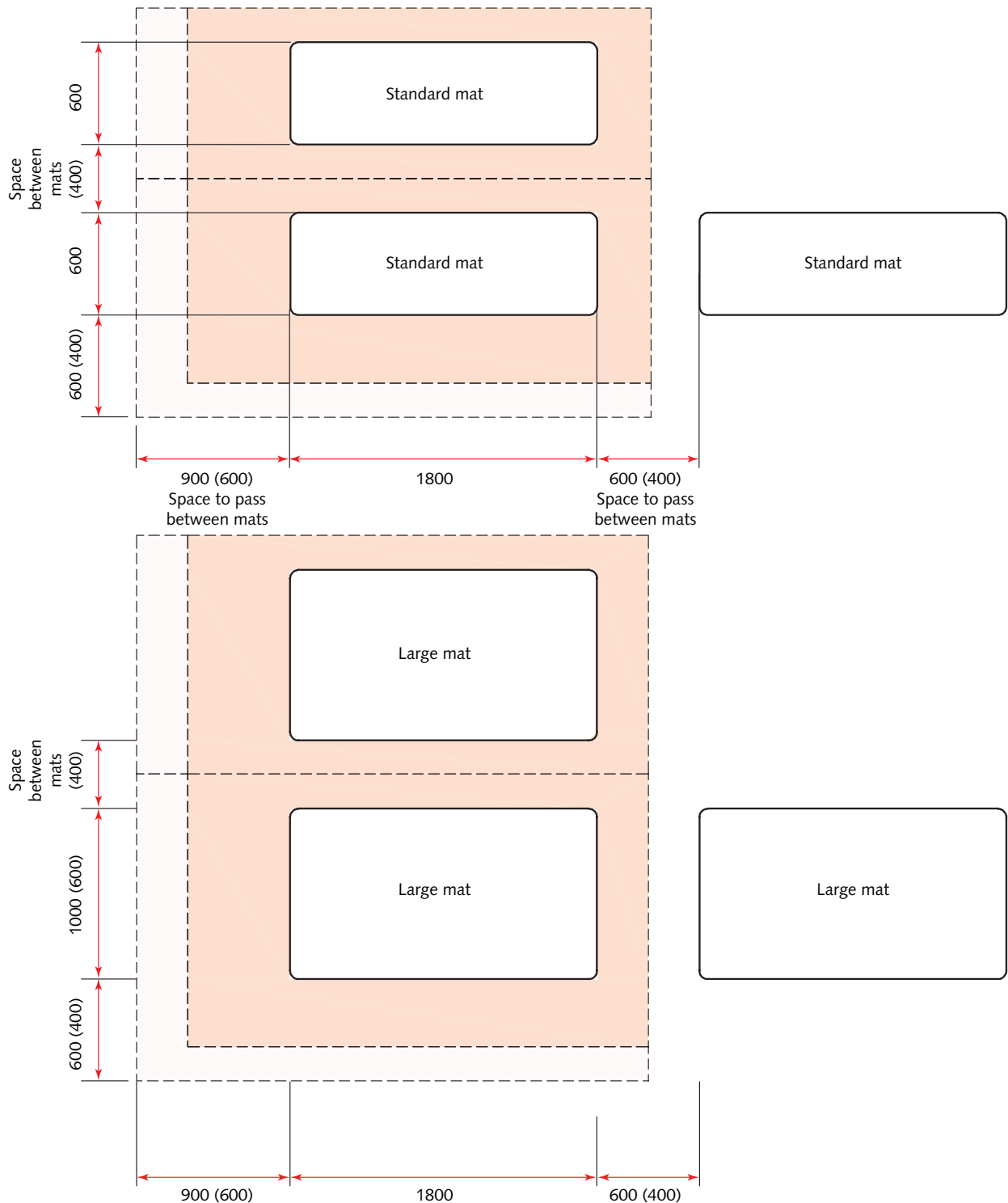

## Group room

### Room description and layout

- 4.6 A group room is basically a room with minimal fittings that can be furnished in different ways for different activities. The room layout provided (see Figure 35) shows a 32 m<sup>2</sup> group room when empty.
- 4.7 Chairs may be arranged in rows for seminars/conferences or around a central table for meetings. Alternatively, mats may be brought into the room for exercise classes (for example antenatal classes, yoga, pilates etc).
- 4.8 For flexibility, an adjacent space should be provided for the storage of equipment and furniture when it is not in use within the room.
- 4.9 Full blackout facilities are rarely necessary although there should be some means of darkening the room. Where blackout facilities are required, special attention should be given to ventilation requirements.
- 4.10 Socket-outlets should be positioned so that laptops, projectors etc can be used with minimum danger from trailing cables.
- 4.11 Videoconferencing and TV facilities and an induction loop hearing aid system may be provided in 32 m<sup>2</sup> group rooms used for meetings and/or seminars.
- 4.12 Access is required to beverage-making facilities.
- 4.13 A clinical wash-hand basin and gel dispenser may be provided to allow for clinical use of the room. However, it must be noted that the inclusion of a basin will significantly influence the perception of the space and will reduce the flexibility of locating mobile furniture for different room uses.

Figure 35 Empty 32 sq m group room

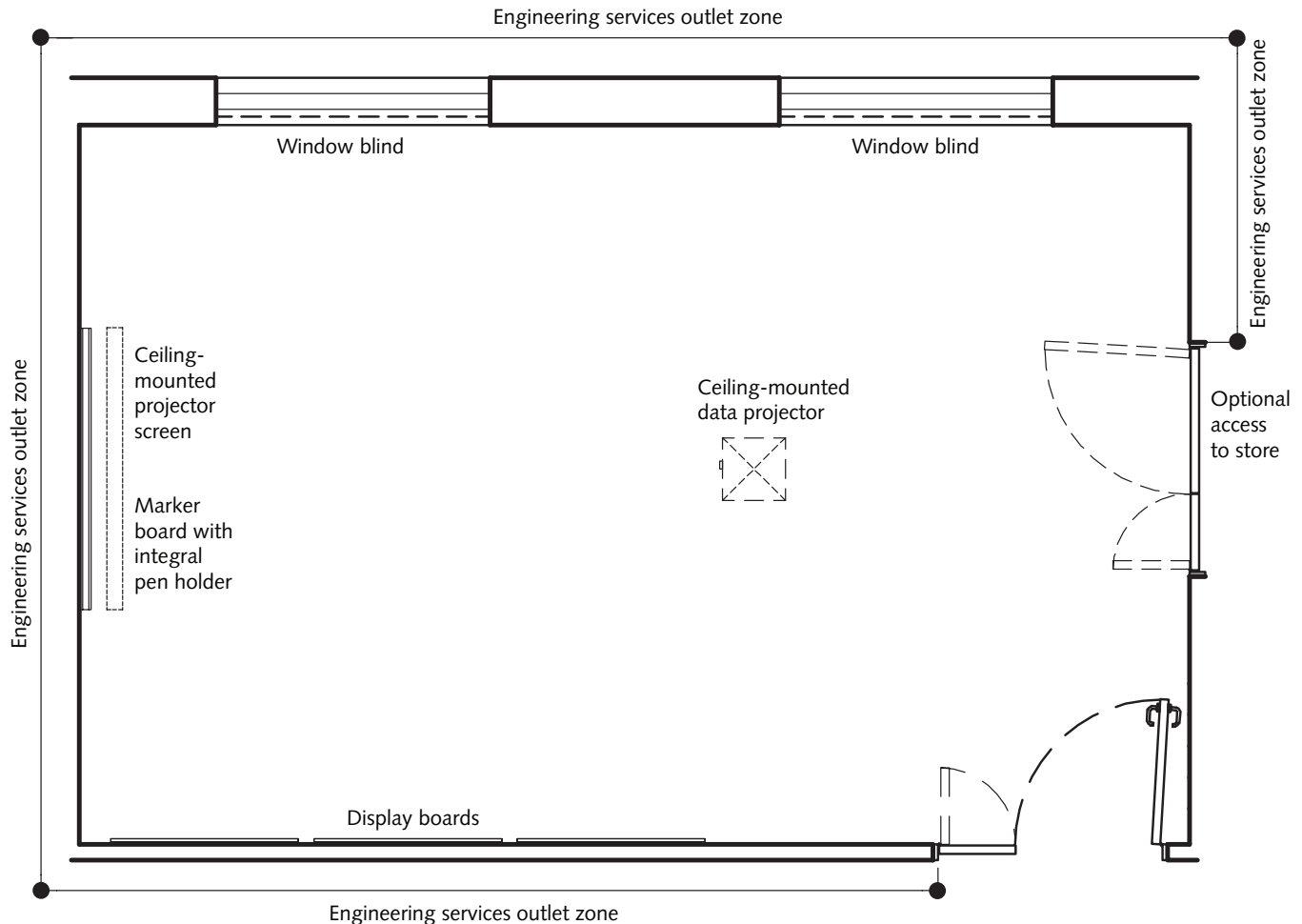

## Meeting room: 7 places

### Room description and layout

- 4.14 Meeting spaces may be distributed throughout a facility or located together in a meeting/conference suite. See Figure 36.
- 4.15 A 7-place meeting space may be an enclosed room or a zone/alcove within an open plan area.
- 4.16 When the room is full to capacity, there will be some compromise on the available space for those sitting at the corners of the table.

4.17 For sizing meeting rooms, the following allowances may be used:

- 2 m<sup>2</sup> per stacking chair (allows for part use of table);
- 4 m<sup>2</sup> per wheelchair place (allows for part of use of table).

Figure 36 Meeting room: 7 places including 1 wheelchair place

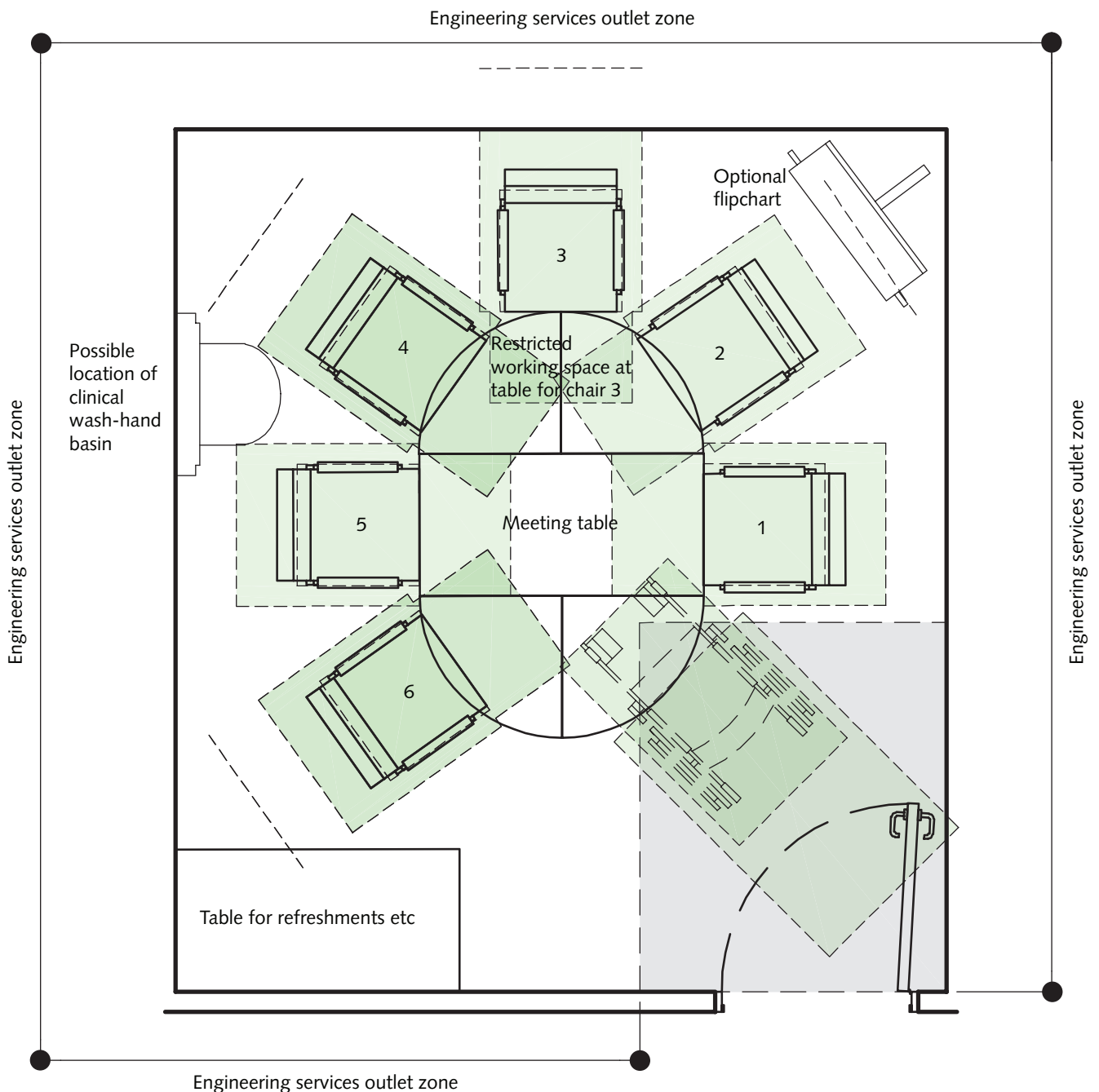

**Ergonomic drawings**

*Working at a desk/table*

- 4.18 This ergonomic drawing (see Figure 37) illustrates the space requirements for working at a desk/table.
- 4.19 The chair shown is a standard stacking chair. Where larger chairs are used, the space should be

increased by an additional 100 mm in each direction.

- 4.20 The space requirement for a wheelchair user is based on a standard wheelchair.
- 4.21 The working zone on the desk/table is 700 mm wide by 500 mm deep. This may be compromised if two users sit at 90 degrees to one another at the corner of the desk/table.

Figure 37 Space requirements for working at a desk/table

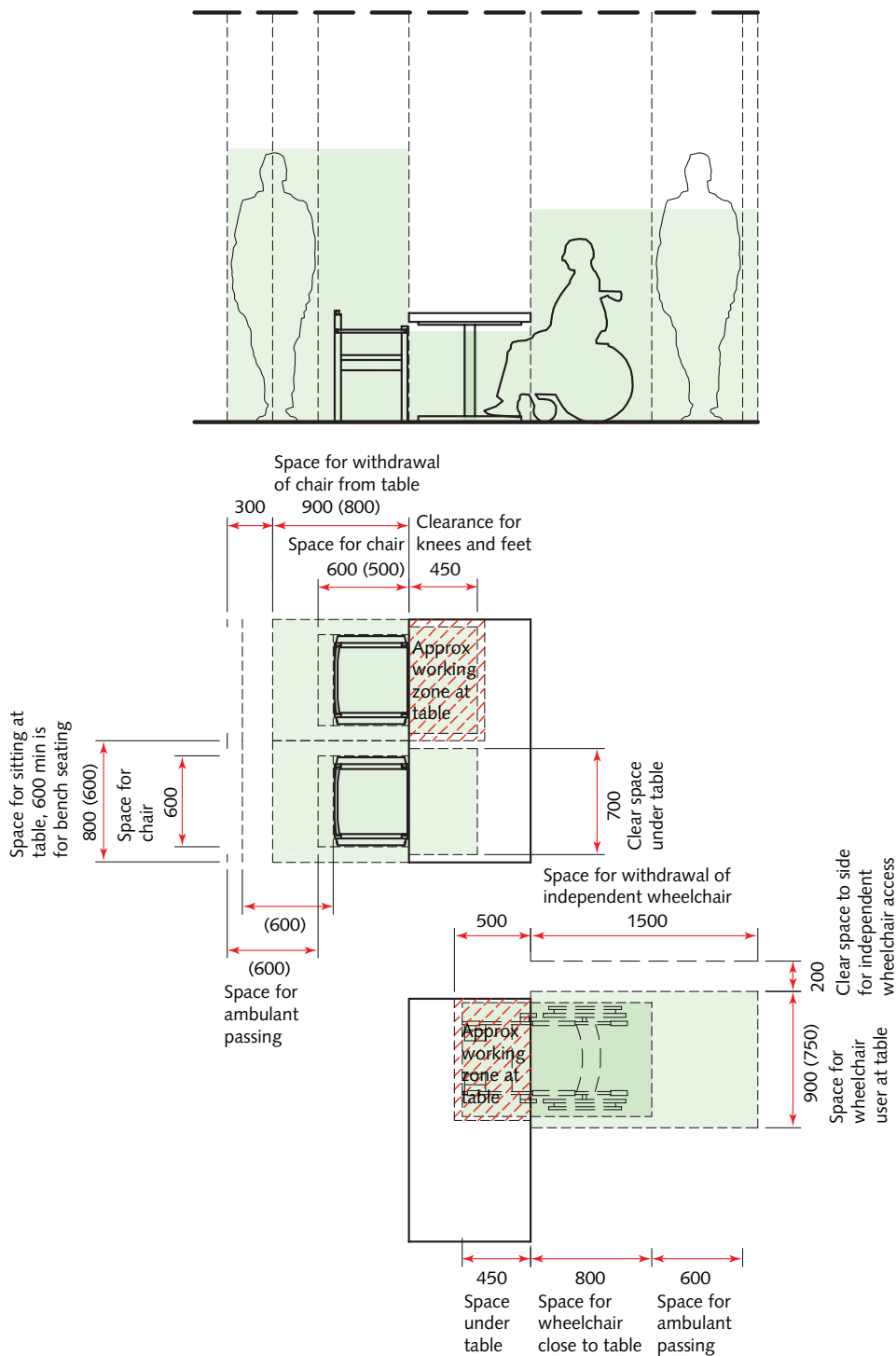

## Meeting room: 16 places

### Room description and layout

- 4.22 Meeting spaces may be distributed throughout a facility or located together in a meeting/conference suite.
- 4.23 The room layout provided (see Figure 38) shows a 32 m<sup>2</sup> group room furnished for use as a meeting room.

- 4.24 When the room is full to capacity, there will be some compromise on the available space for those sitting at the corners of the table.
- 4.25 For sizing meeting rooms, the following allowances may be used:
- 2 m<sup>2</sup> per stacking chair (allows for part use of table);
  - 4 m<sup>2</sup> per wheelchair place (allows for part of use of table).

Figure 38 Meeting room: 16 places





**Ergonomic drawings**

*Working at a desk/table*

- 4.26 This ergonomic drawing (see Figure 39) illustrates the space requirements for working at a desk/table.
- 4.27 The chair shown is a standard stacking chair. Where larger chairs are used, the space should be

increased by an additional 100 mm in each direction.

- 4.28 The space requirement for a wheelchair user is based on a standard wheelchair.
- 4.29 The working zone on the desk/table is 700 mm wide by 500 mm deep. This may be compromised if two users sit at 90 degrees to one another at the corner of the desk/table.

Figure 39 Space requirements for working at a desk/table

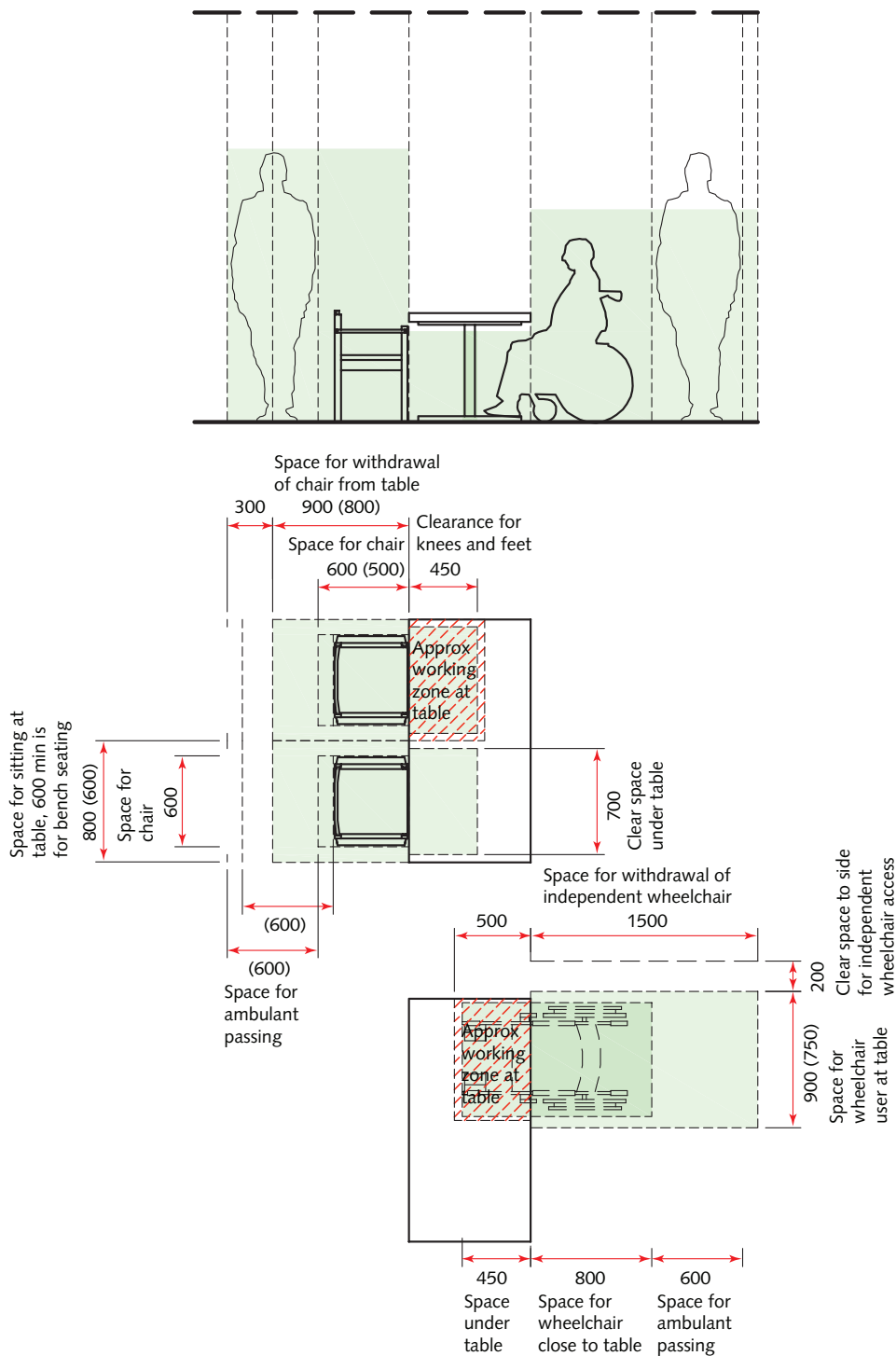

## Seminar room

### Room description and layout

4.30 The room layout provided (see Figure 40) shows a 32 m<sup>2</sup> group room furnished for use as a seminar room. It can accommodate 24 people including one wheelchair user, plus the practitioner at the front of the room.

4.31 An overhead projector and, in larger seminar rooms, public address system may be provided.

4.32 For sizing seminar rooms, the following allowances may be used:

- 4–5 m<sup>2</sup> for desk and equipment for practitioner at front of room;
- 1.2 m<sup>2</sup> per stacking chair;
- 4 m<sup>2</sup> per wheelchair space.

Figure 40 Seminar room: 24 places including 1 wheelchair place

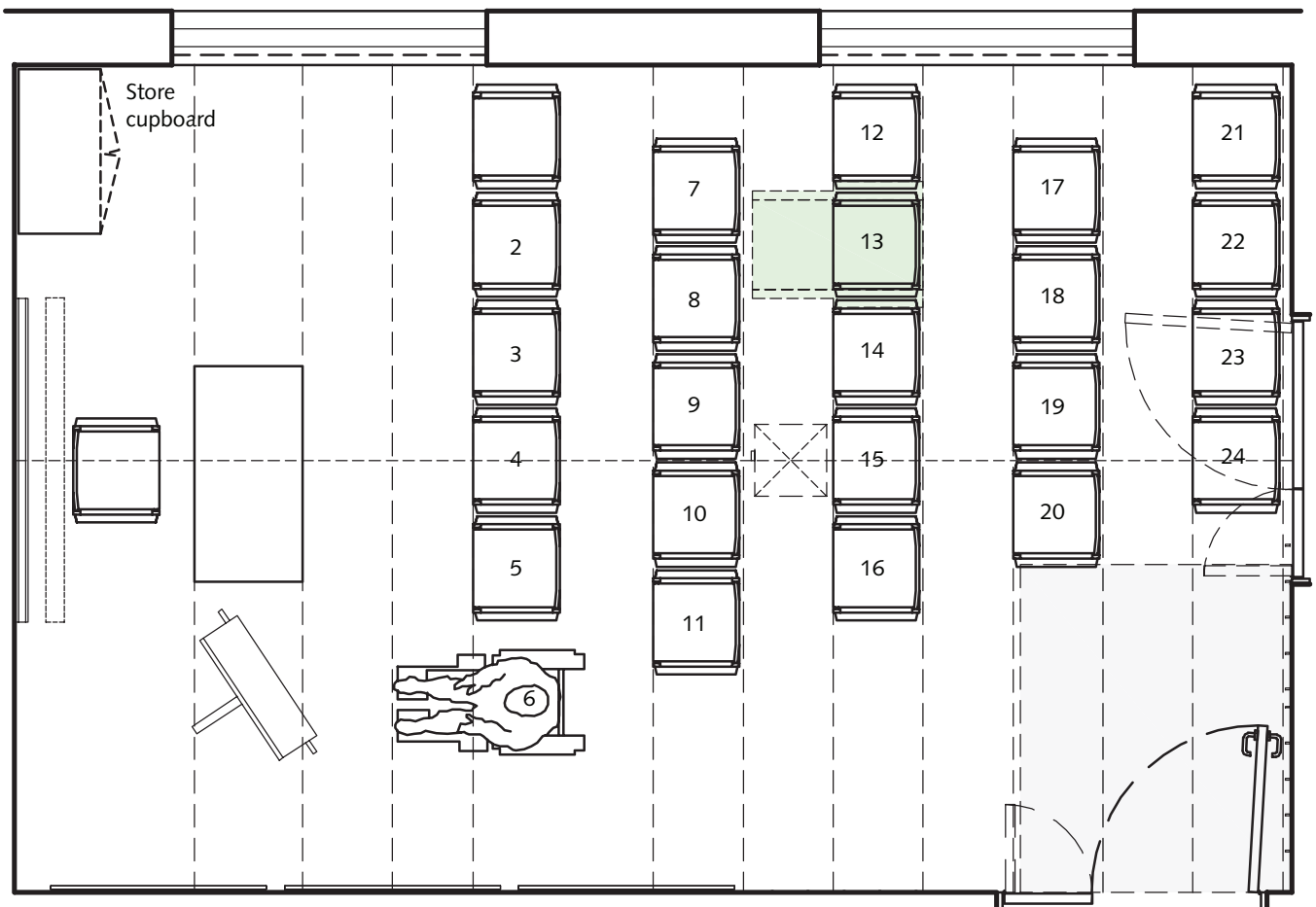

**Ergonomic drawings**

*Seminar activities*

4.33 This ergonomic drawing (see Figure 41) illustrates space requirements for seminar activities.

4.34 For optimum vision of the screen:

- rows of seats should be staggered;
- a maximum of five seats in the front row is recommended for an 1800 mm wide screen;

- the distance from the front row to the screen should be twice the width of the screen or a minimum of 3000 mm;
- in large rooms, the bottom of the screen may need to be raised.

4.35 Where a large number of semi-ambulant users need to be accommodated, the minimum passing space between rows of chairs should increase to 900–1200 mm. See BS 8300 (paragraph 11.2.2).

Figure 41 Space requirements for seminar activities

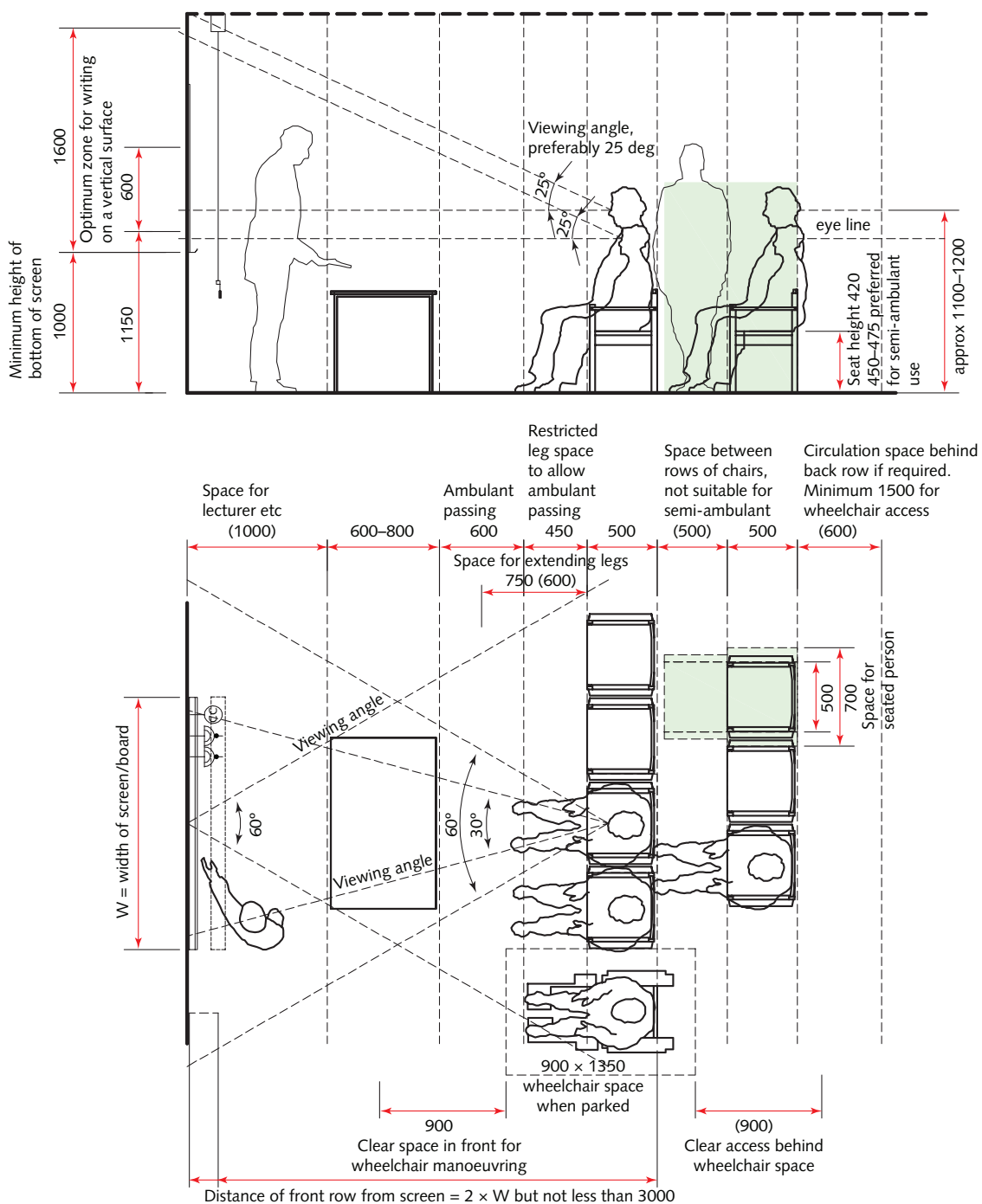

# 5 Generic clinical spaces: Recovery spaces

## Recovery/assessment room (2 places)

### Room description and layout

- 5.1 A recovery/assessment space is intended as a generic space where patient recovery following a procedure requiring local anaesthetic or sedation (not general anaesthetic) and a variety of assessments (for example maternity) and treatments (for example dialysis) may be undertaken. Patients may also be transferred here from a post-anaesthetic recovery area.
- 5.2 It may be co-located with a seated recovery area and/or post-anaesthetic recovery area.
- 5.3 Immediate access is required to a resuscitation trolley. If this is not held within the room, it should be located conveniently nearby.
- 5.4 An overall width of 3350 mm is required for mobile hoist transfer. Therefore, 600 mm of the adjacent space will be required for this purpose.
- 5.5 Natural light should be provided.
- 5.6 See Health Technical Memorandum 02-01 – ‘Medical gas pipeline systems’ and Health Technical Memorandum 08-03 – ‘Bedhead services’ for specific requirements on the use of medical gases.
- 5.7 The room layout provided (see [Figure 42](#)) includes two couches. It is assumed there will be one practitioner for every two patients/clients. When this space is used, consideration must be given to the ‘Delivering Same Sex Accommodation’ programme (DSSA), including the attendance of partners/carers.
- 5.8 For sizing recovery/assessment rooms generally, the following allowances may be used:
- 9 m<sup>2</sup> per couch/reclining treatment chair;
  - 4–6 m<sup>2</sup> for clinical support (for example clinical workstation, clinical wash-hand basin etc).

Figure 42 Recovery/assessment room

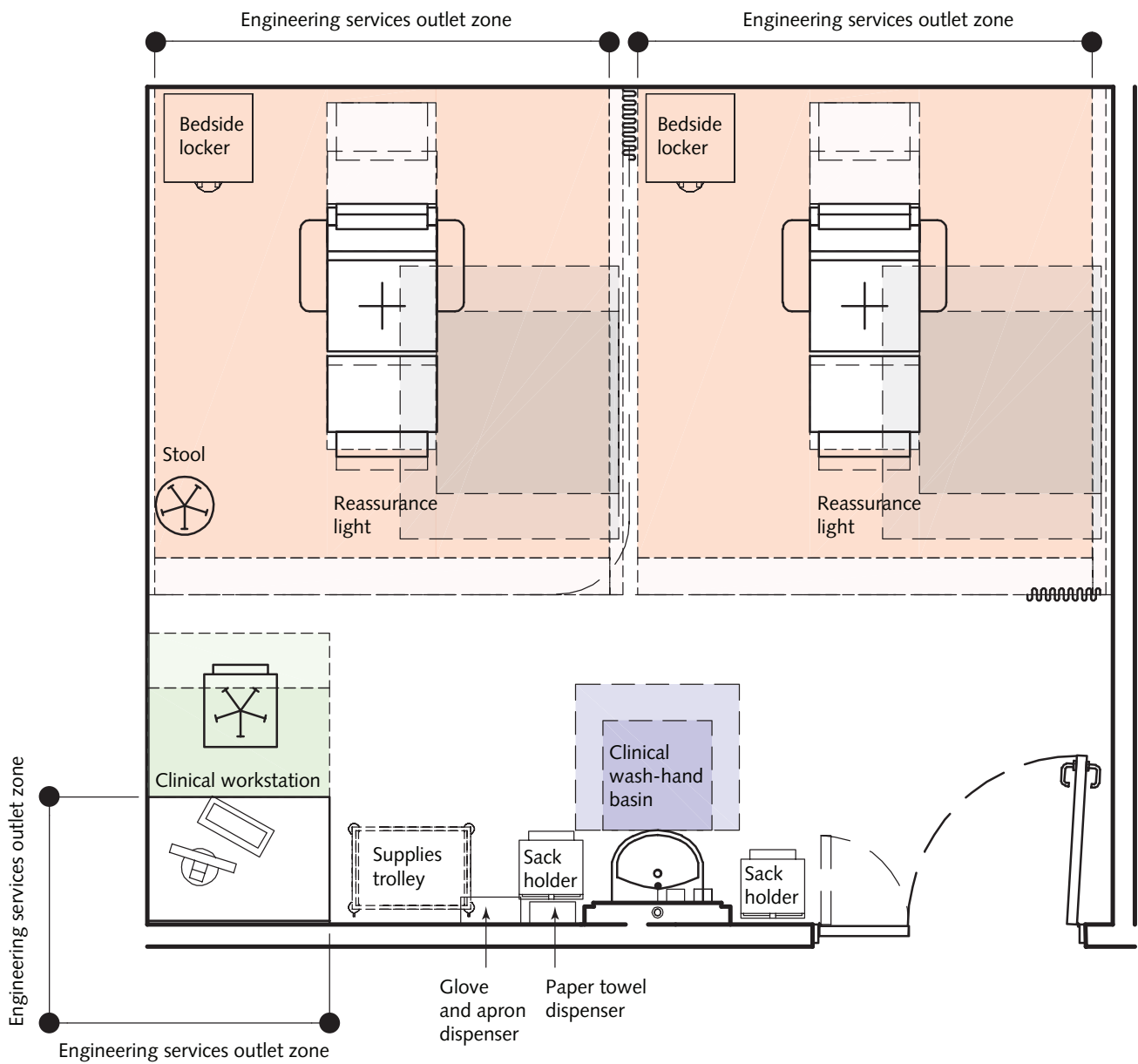

**Ergonomic drawings**

*Clinical wash-hand basin*

- 5.9 These ergonomic drawings (see Figure 43) show the space requirements for standing use of a clinical wash-hand basin assembly. For seated use, the basin will need to be lowered.
- 5.10 The basin should be fitted with non-touch taps.
- 5.11 The recommended fixing height of a lever tap on a clinical wash-hand basin is 1095 mm. Where a lever tap is used, the fixing height of the dispensers should be chosen to reduce any possible conflicts in use.
- 5.12 The illustrated clinical wash-hand basin projects 400 mm from the back panel or wall. However, clinical wash-hand basins may vary from 350 to 500 mm projection. Where basins deeper than 400 mm are used, the impact on/from other components and/or activities undertaken within any space should be considered when evaluating any room layout.
- 5.13 The glove and apron dispenser illustrated is a combined unit; this is considered the most compact solution although separate units may also be used. Even the most compact unit cannot practically be located within comfortable reach of the basin; it should, however, be conveniently located within the room.
- 5.14 The ergonomic advice for the height of horizontal elbow operated lever taps is based on the following data:  
 “Elbow height for shod, slightly bent posture (as when leaning forward) for 50%ile UK male = 1134 mm, for female 1049 mm. 1090 mm is considered the best compromise for an elbow height for both male and female use. The ergonomic advice for the height of a lever tap is 75 mm below elbow height giving a figure height of approx 1015 mm.”
- 5.15 Lever taps are not illustrated.
- 5.16 For detailed information on basins, see Health Building Note 00-10 Part C – ‘Sanitary assemblies’.

Figure 43 Space requirements for standing use of a clinical wash-hand basin assembly

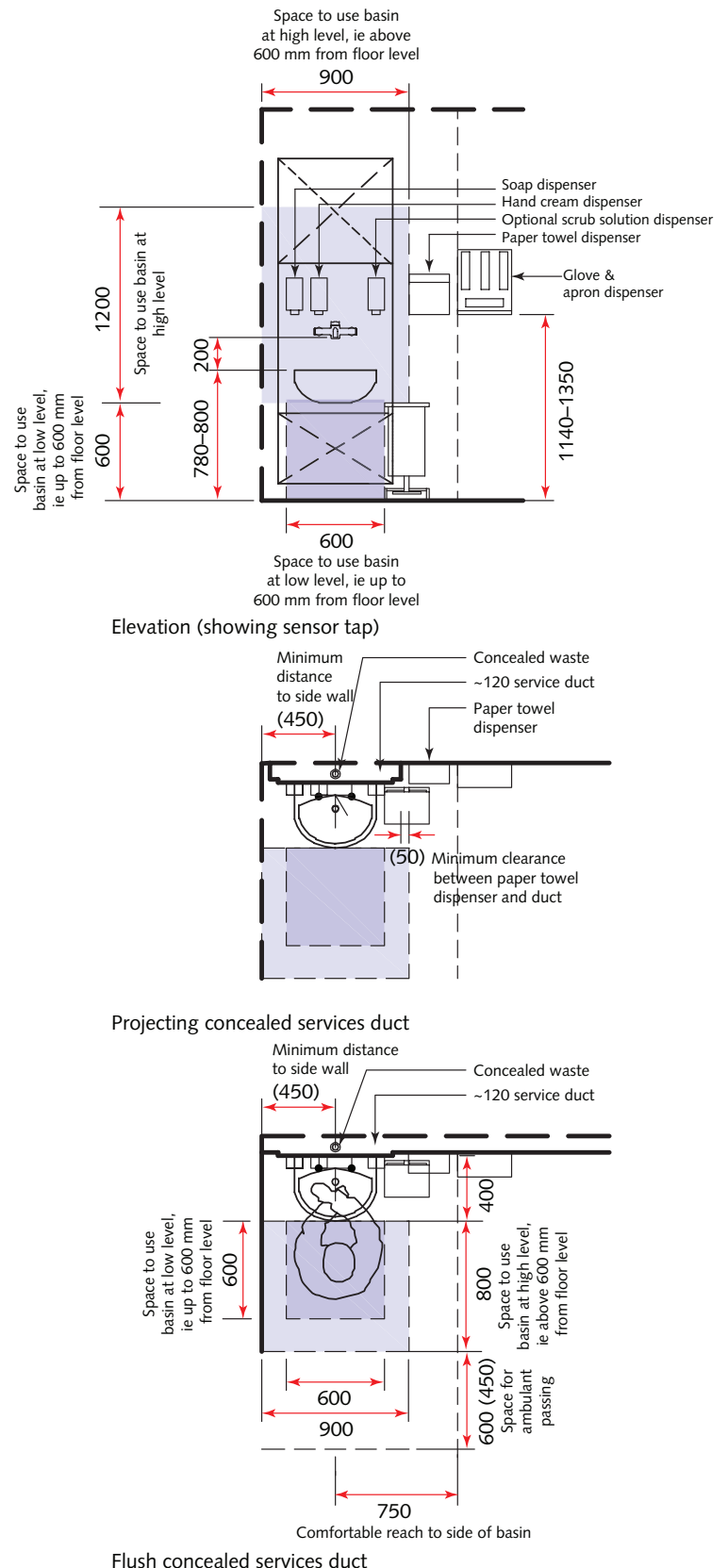

*Clinical workstation*

5.17 This ergonomic drawing (see Figure 44) shows the space requirements for a clinical workstation.

5.18 The clinical workstation is intended for accessing and updating patient records within a clinical environment. It should only be used for short periods of time.

Figure 44 Space requirements for a clinical workstation

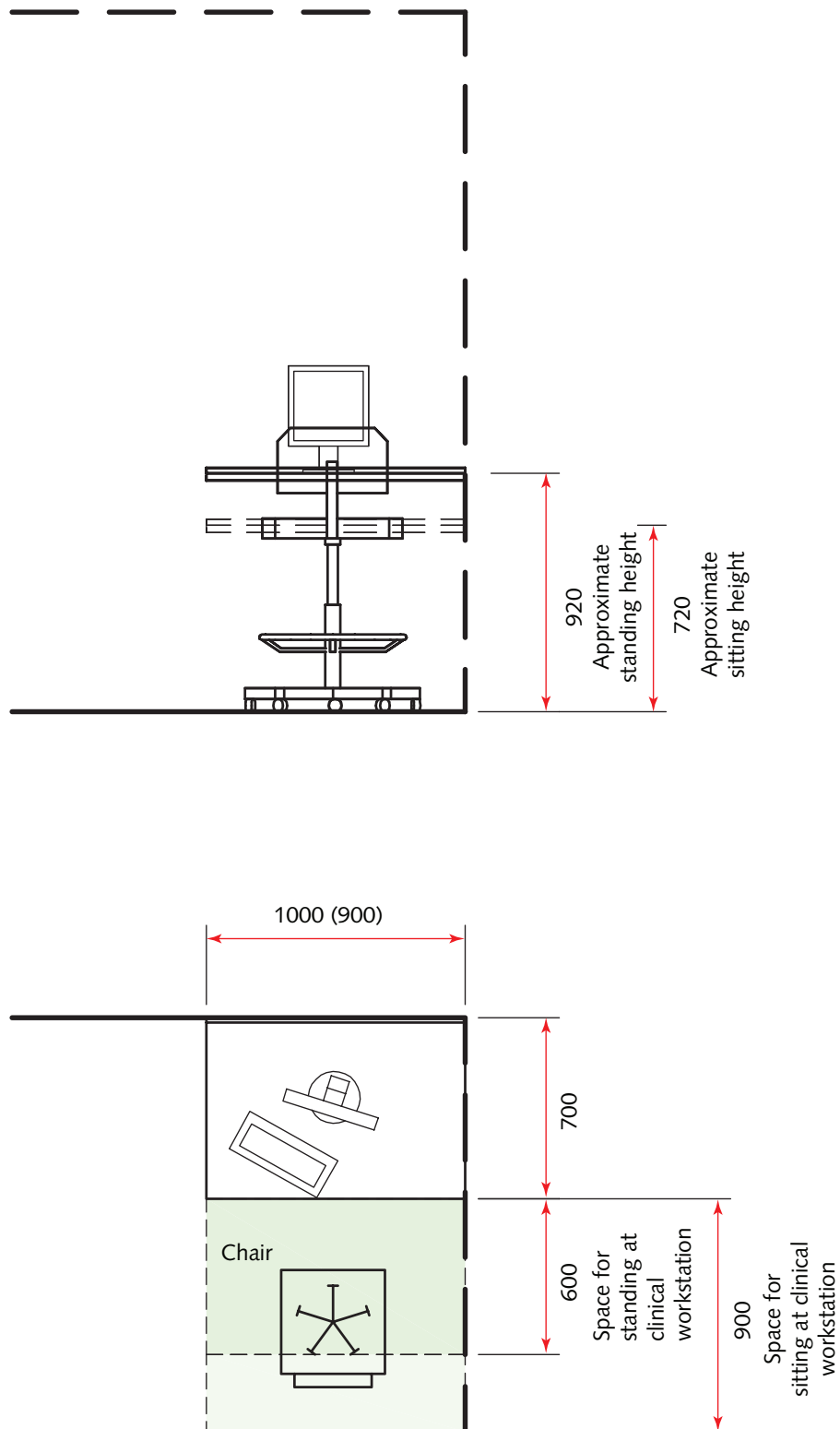

*Treatment chairs (various): double-sided access*

- 5.19 These ergonomic drawings (see Figure 45) show the space requirements for double-sided access to a variety of treatment chairs.
- 5.20 The reclining treatment/therapy chair provides the most flexible option for general examinations and treatments.
- 5.21 The reclining gynaecology chair may be used for general examinations and treatments or female internal examinations. A variety of attachments are available to assist internal examinations of females

including stirrups, leg supports or footrests. The use of the various methods is subject to local clinical and/or patient/client preferences.

- 5.22 The podiatry treatment chair incorporates separate leg supports, which may be adjusted independently of one another.
- 5.23 The activity space for the podiatry treatment chair assumes the examination light is attached to the podiatry trolley. The illustrated chair is mobile. Floor-mounted chairs are also available although these may reduce flexibility in room use.

Figure 45 Space requirements for double-sided access to a variety of treatment chairs

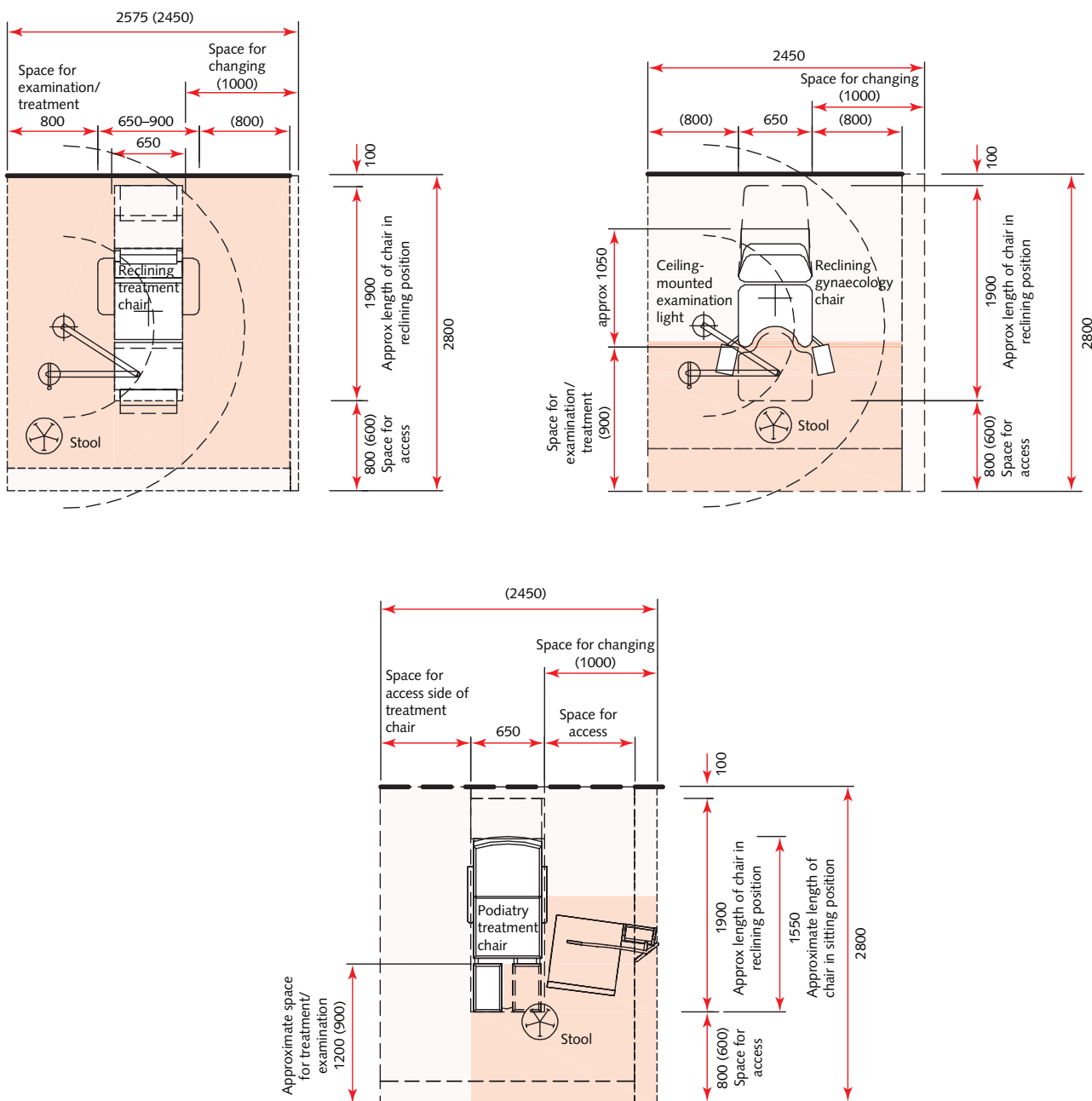



*Dressing and undressing: ambulant*

- 5.24 These ergonomic drawings (see Figure 46) show the space requirements for ambulant dressing and undressing.
- 5.25 An identical space provision is suitable for semi-ambulant users though it should be located adjacent to a seating area.

Figure 46 Space requirements for ambulant dressing and undressing

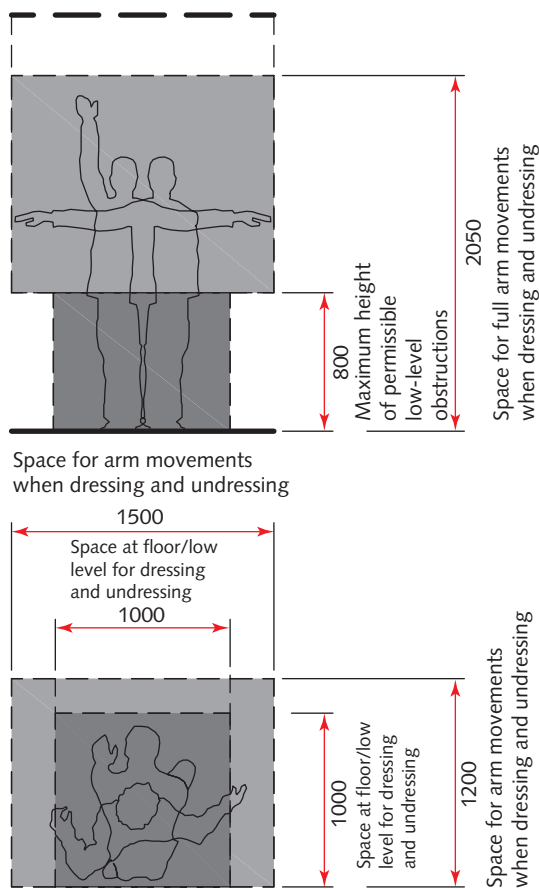

**Seated recovery area**

**Room description**

- 5.26 This is an open-plan area with easy chairs. It will be used for patients with low clinical needs to sit and recover following a procedure (which may have required a local anaesthetic).
- 5.27 It should be an open-plan lounge-type space with comfortable upholstered, easily cleanable, chairs and may simply form a discrete part of a waiting area.
- 5.28 The area should contain a separate zone for clinical hand-washing.
- 5.29 Natural light should be provided.
- 5.30 Beverage facilities should be available nearby.
- 5.31 No room layout has been provided. For sizing seated recovery areas, the following allowances may be used:
  - 1.5 m<sup>2</sup> per easy chair;
  - 3 m<sup>2</sup> per wheelchair space.

## 6 Generic clinical spaces: Treatment rooms

### Treatment room: all-round couch access

#### Room description and layout

- 6.1 This room is intended as a flexible clinical space to be used by a wide range of specialties.
- 6.2 The room has been sized to accommodate mobile diagnostic equipment, for example mobile ultrasound equipment.
- 6.3 It is assumed that sterile instruments and dressings will be held within the treatment room on an instruments/dressings trolley. The trolley may be prepared in the treatment room or an associated clean utility room.
- 6.4 Medical oxygen and vacuum will generally be required. Medical air, nitrous oxide and gas scavenging may also be required. See Health Technical Memorandum 02-01 for specific requirements.
- 6.5 Treatment rooms should be mechanically ventilated, with 10 air changes per hour supply and extract.
- 6.6 The following procedures require a treatment room (that is, with mechanical ventilation):
  - invasive procedures, that is, procedures that cut the superficial layers of the skin, for example removal of moles, warts, corns, biopsies etc;
  - use of certain rigid endoscopes including laryngoscopes (used during resuscitation procedures), otoscopes and ophthalmoscopes.
- 6.7 Blackout blinds and dimmable lighting are recommended for flexibility in use, for example sessional ultrasound, ENT or eye care use.
- 6.8 The room layout provided (see [Figure 47](#)) shows a standard three-section couch.
- 6.9 The alternative door location (that is, to match the layout of option 1 of the double-sided couch access consulting/examination) implies that the window would be located behind the couch. This would require privacy control, which is not good, psychologically, for patients. However, it would provide better trolley access to the couch in an emergency.

Figure 47 Treatment room: all-round couch access

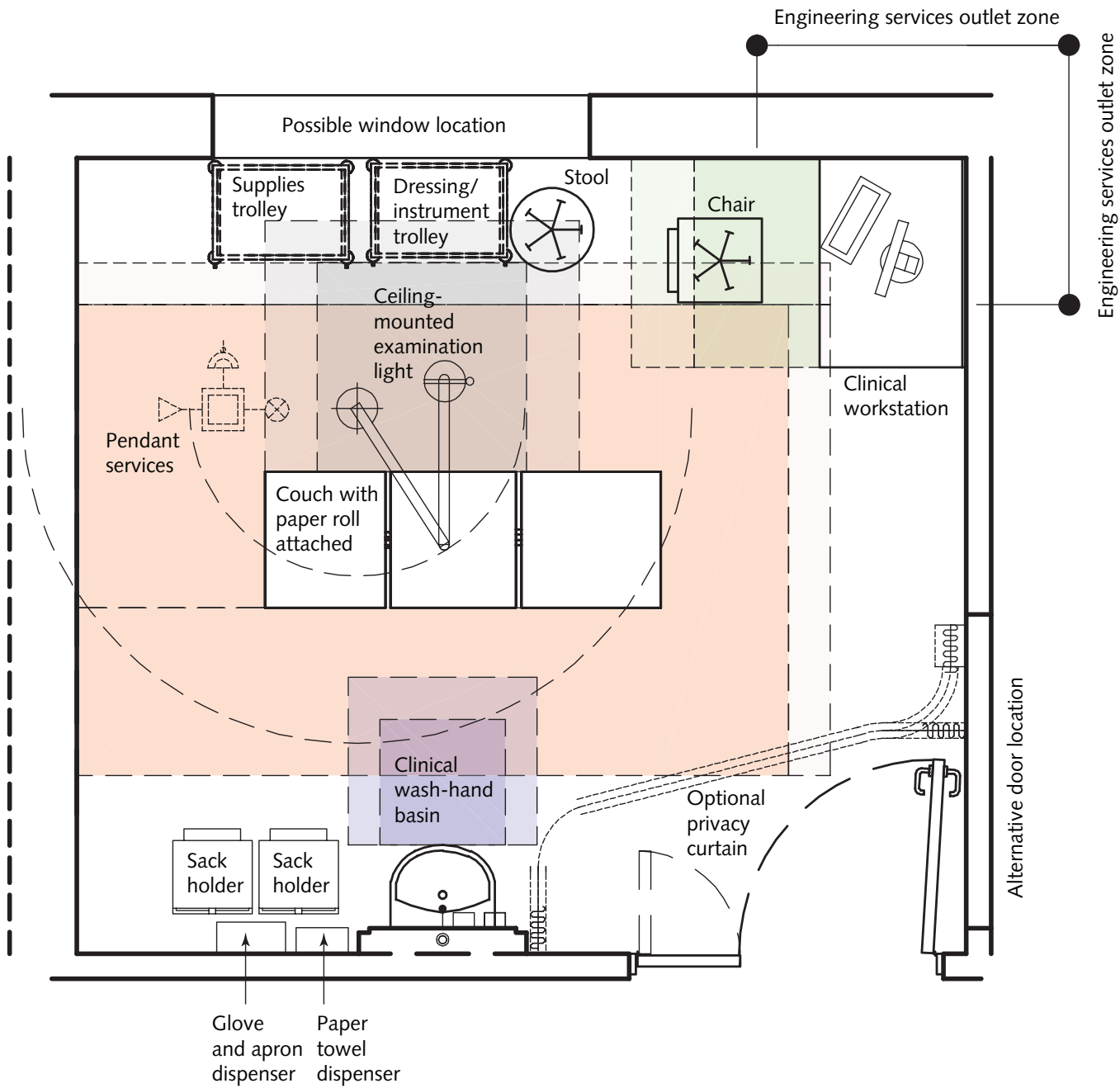

## Ergonomic drawings

### Clinical wash-hand basin

- 6.10 These ergonomic drawings (see Figure 48) show the space requirements for standing use of a clinical wash-hand basin assembly. For seated use, the basin will need to be lowered.
- 6.11 The basin should be fitted with non-touch taps.
- 6.12 The recommended fixing height of a lever tap on a clinical wash-hand basin is 1095 mm. Where a lever tap is used, the fixing height of the dispensers should be chosen to reduce any possible conflicts in use.
- 6.13 The illustrated clinical wash-hand basin projects 400 mm from the back panel or wall. However, clinical wash-hand basins may vary from 350 to 500 mm projection. Where basins deeper than 400 mm are used, the impact on/from other components and/or activities undertaken within any space should be considered when evaluating any room layout.
- 6.14 The glove and apron dispenser illustrated is a combined unit; this is considered the most compact solution although separate units may also be used. Even the most compact unit cannot practically be located within comfortable reach of the basin; it should, however, be conveniently located within the room.
- 6.15 The ergonomic advice for the height of horizontal elbow operated lever taps is based on the following data:  
 “Elbow height for shod, slightly bent posture (as when leaning forward) for 50%ile UK male = 1134 mm, for female 1049 mm. 1090 mm is considered the best compromise for an elbow height for both male and female use. The ergonomic advice for the height of a lever tap is 75 mm below elbow height giving a figure height of approx 1015 mm.”
- 6.16 Lever taps are not illustrated.
- 6.17 For detailed information on basins, see Health Building Note 00-10 Part C – ‘Sanitary assemblies’.

Figure 48 Space requirements for standing use of a clinical wash-hand basin assembly

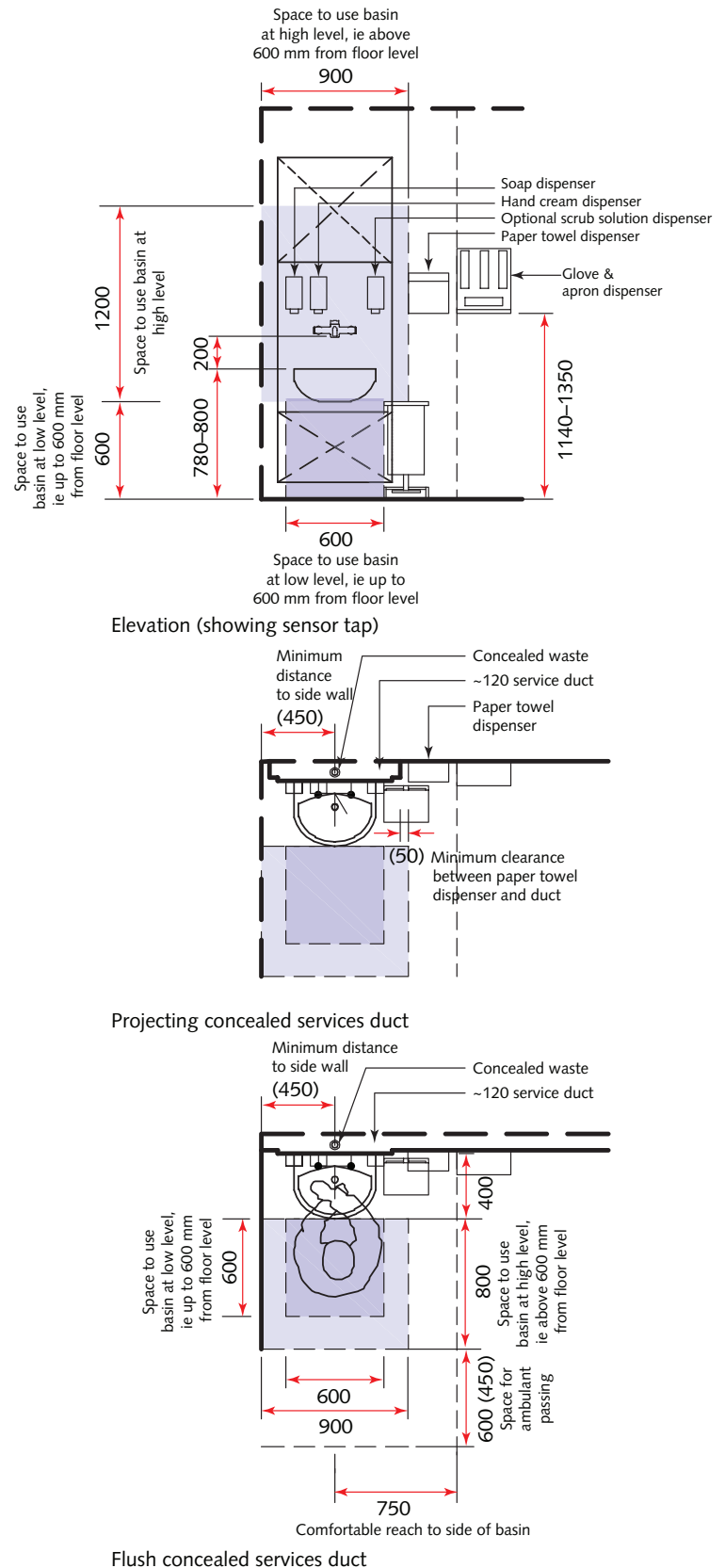

*Clinical workstation*

6.18 This ergonomic drawing (see Figure 49) shows the space requirements for a clinical workstation.

6.19 The clinical workstation is intended for accessing and updating patient records within a clinical environment. It should only be used for short periods of time.

Figure 49 Space requirements for a clinical workstation

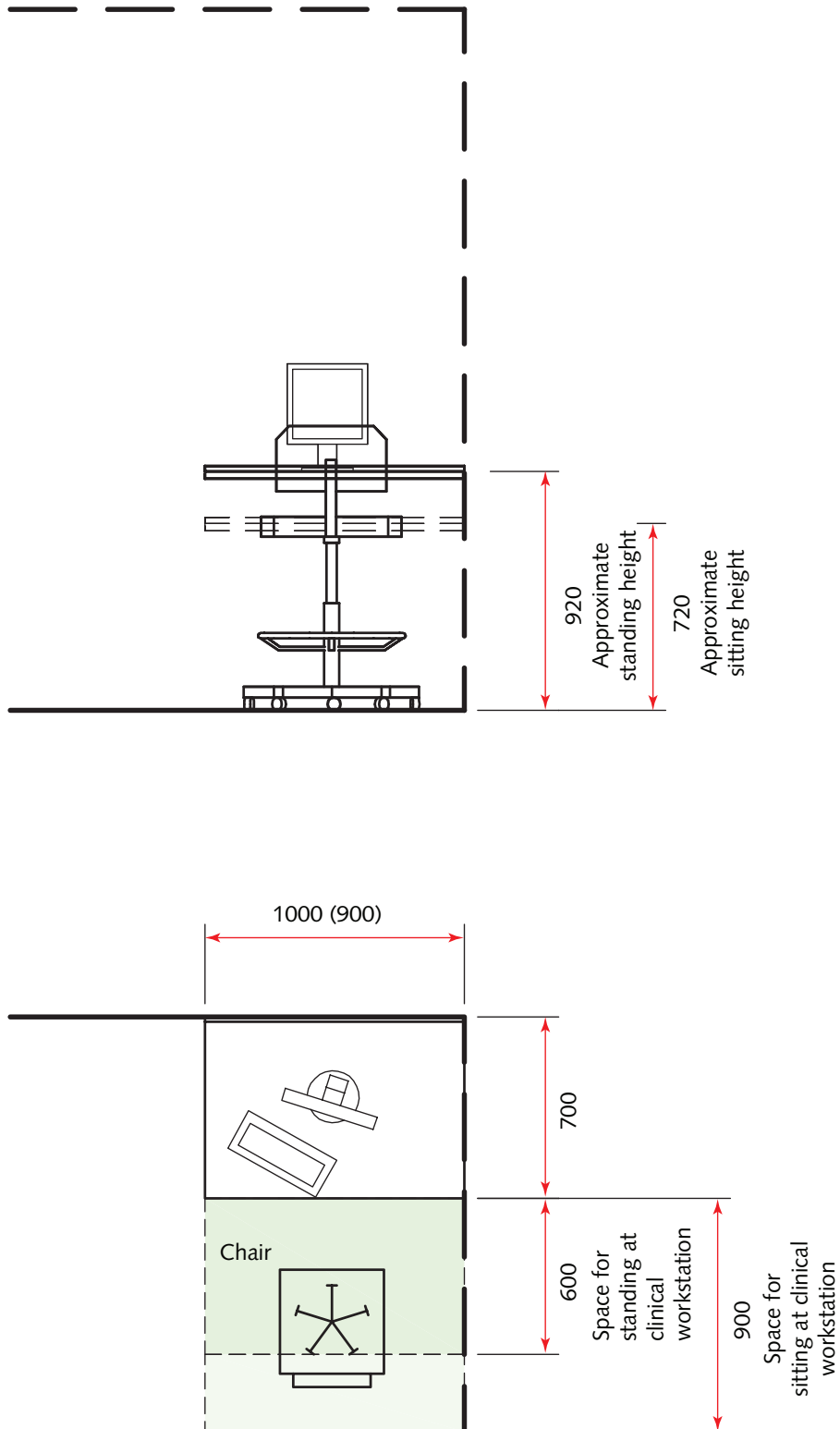

*Couch with all-round access*

- 6.20 This ergonomic drawing (see Figure 50) shows the space requirements for all-round access to a three-section couch.
- 6.21 Pendant services should be provided where all-round couch access is required. The type of pendant will vary depending on the services being provided.

- 6.22 The type of pendant required will vary depending upon the level of services being provided (for example fixed power and data only, power data and medical gas with vertical adjustment, or with vertical and horizontal adjustment etc). However, this document assumes that in a generic treatment room only simple services are anticipated.

Figure 50 Space requirements for all-round access to three-section couch

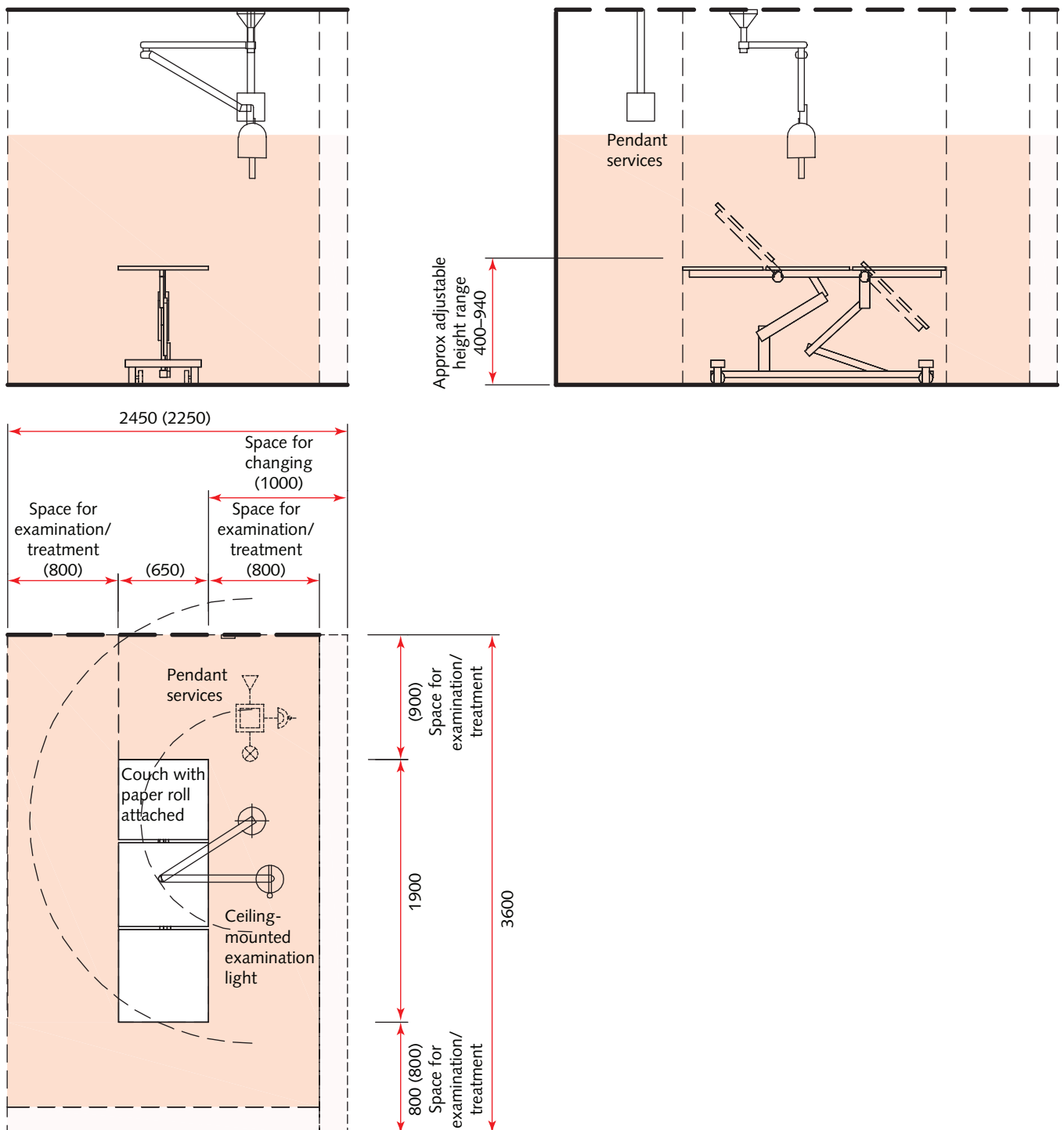

*Dressing and undressing: ambulant*

6.23 These ergonomic drawings (see Figure 51) show the space requirements for ambulant dressing and undressing.

6.24 An identical space provision is suitable for semi-ambulant users though it should be located adjacent to a seating area.

Figure 51 Space requirements for ambulant dressing and undressing

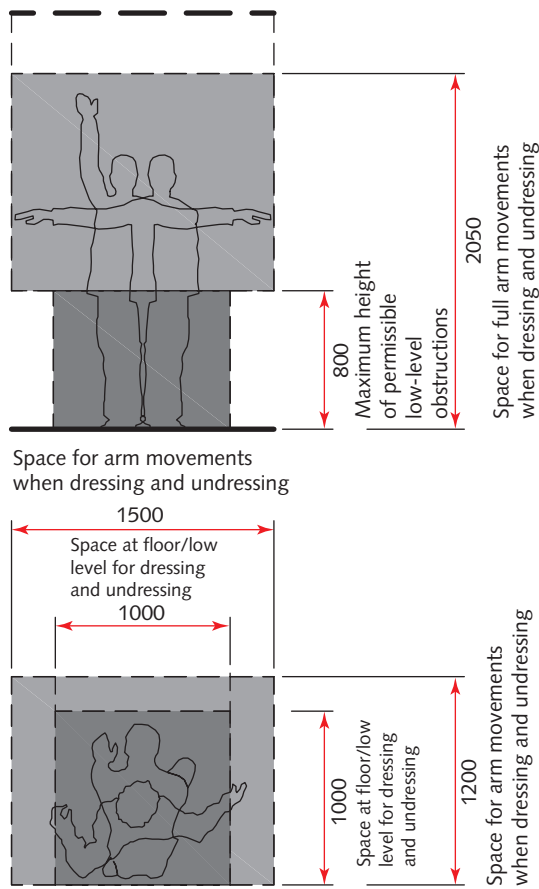

## Treatment room: double-sided couch access

### Room description and layout

- 6.25 This room is intended as a flexible clinical space to be used by a wide range of specialties.
- 6.26 The room has been sized to accommodate mobile diagnostic equipment, for example mobile ultrasound equipment.
- 6.27 It is assumed that sterile instruments and dressings will be held within the treatment room on an instruments/dressings trolley. The trolley may be prepared in the treatment room or an associated clean utility room.
- 6.28 Medical oxygen and vacuum will generally be required. Medical air, nitrous oxide and gas scavenging may also be required. See Health Technical Memorandum 02-01 for specific requirements.
- 6.29 Treatment rooms should be mechanically ventilated, with 10 air changes per hour supply and extract.
- 6.30 The following procedures require a treatment room (that is, with mechanical ventilation):
- invasive procedures, that is, procedures that cut the superficial layers of the skin, for example removal of moles, warts, corns, biopsies etc;
  - use of certain rigid endoscopes including laryngoscopes (used during resuscitation procedures), otoscopes and ophthalmoscopes.
- 6.31 Blackout blinds and dimmable lighting are recommended for flexibility in use, for example sessional ultrasound, ENT or eye care use.
- 6.32 Two room layouts have been provided (see [Figures 52 and 53](#)).
- 6.33 Both layouts include a standard three-section couch and a privacy curtain separating the couch end of the room. Alternatively, a privacy curtain may be included inside the door. See Health Building Note 00-04 for further details.
- 6.34 Option 1 may accommodate an island couch if engineering services are provided using a pendant and the privacy curtain is located just inside the door.
- 6.35 The alternative door location on option 1 (that is, to match the layout of option 1 of the double-sided couch consulting/examination room) implies that the window would be located behind the couch. This would require privacy control within the curtained area, which is not good, psychologically, for patients. However, the alternative door location would provide better patient trolley access to the couch in an emergency.
- 6.36 Option 2 is effectively identical to the consulting/examination room double-sided couch access, option 2. The clinical administration space is on the inside wall of the room (that is, away from the natural light) and the examination space is on the outside wall (that is, requiring privacy control due to the proximity of the window). The room layout cannot comfortably accommodate an island couch layout.



Figure 53 Treatment room: double-sided couch access (option 2)

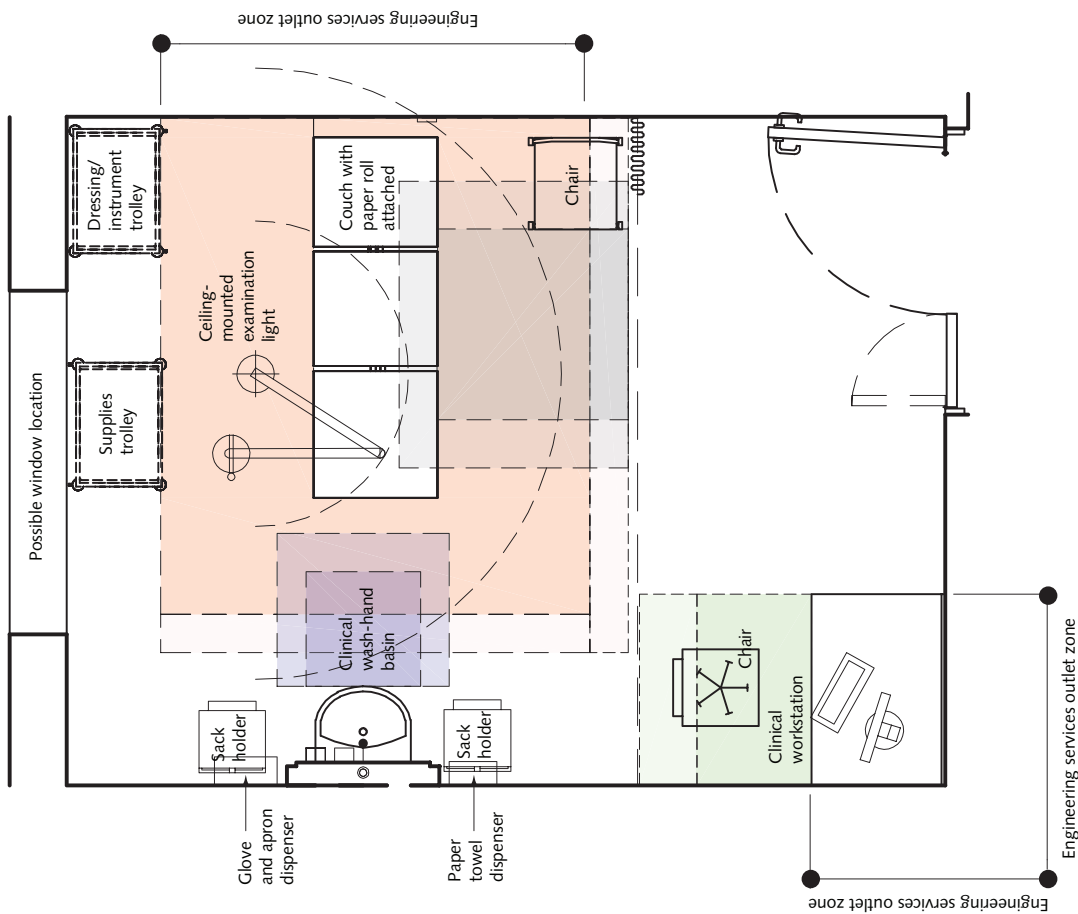
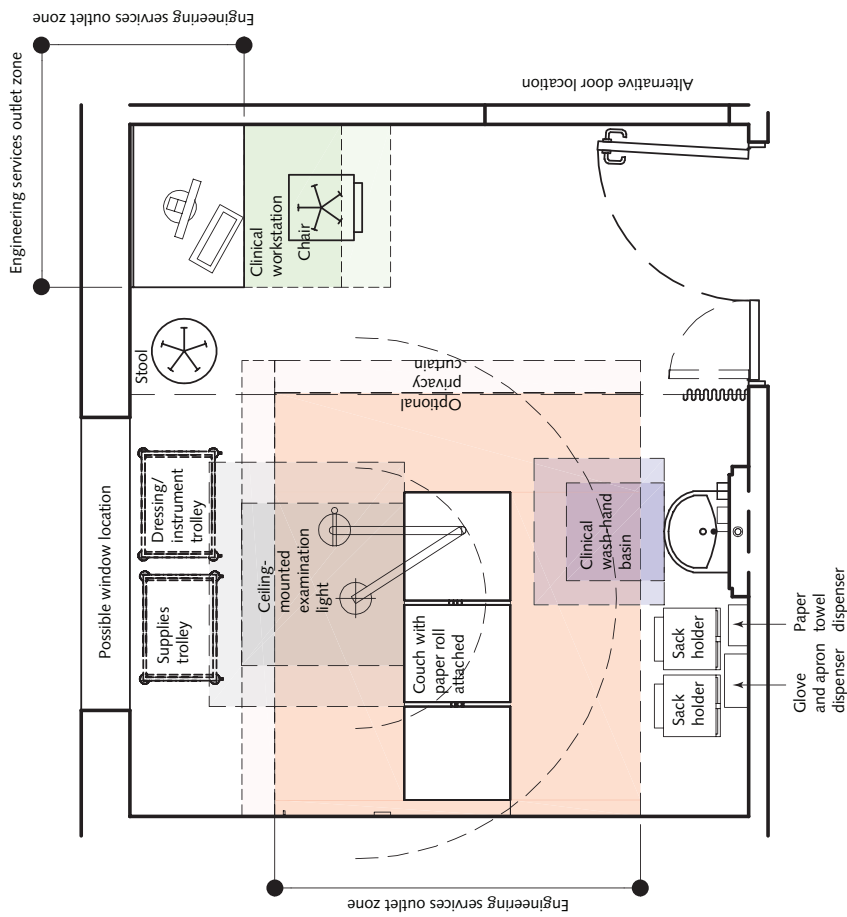

Figure 52 Treatment room: double-sided couch access (option 1)



## Ergonomic drawings

### Clinical wash-hand basin

- 6.37 These ergonomic drawings (see Figure 54) show the space requirements for standing use of a clinical wash-hand basin assembly. For seated use, the basin will need to be lowered.
- 6.38 The basin should be fitted with non-touch taps.
- 6.39 The recommended fixing height of a lever tap on a clinical wash-hand basin is 1095 mm. Where a lever tap is used, the fixing height of the dispensers should be chosen to reduce any possible conflicts in use.
- 6.40 The illustrated clinical wash-hand basin projects 400 mm from the back panel or wall. However, clinical wash-hand basins may vary from 350 to 500 mm projection. Where basins deeper than 400 mm are used, the impact on/from other components and/or activities undertaken within any space should be considered when evaluating any room layout.
- 6.41 The glove and apron dispenser illustrated is a combined unit; this is considered the most compact solution although separate units may also be used. Even the most compact unit cannot practically be located within comfortable reach of the basin; it should, however, be conveniently located within the room.
- 6.42 The ergonomic advice for the height of horizontal elbow operated lever taps is based on the following data:  
 “Elbow height for shod, slightly bent posture (as when leaning forward) for 50%ile UK male = 1134 mm, for female 1049 mm. 1090 mm is considered the best compromise for an elbow height for both male and female use. The ergonomic advice for the height of a lever tap is 75 mm below elbow height giving a figure height of approx 1015 mm.”
- 6.43 Lever taps are not illustrated.
- 6.44 For detailed information on basins, see Health Building Note 00-10 Part C – ‘Sanitary assemblies’.

Figure 54 Space requirements for standing use of a clinical wash-hand basin assembly

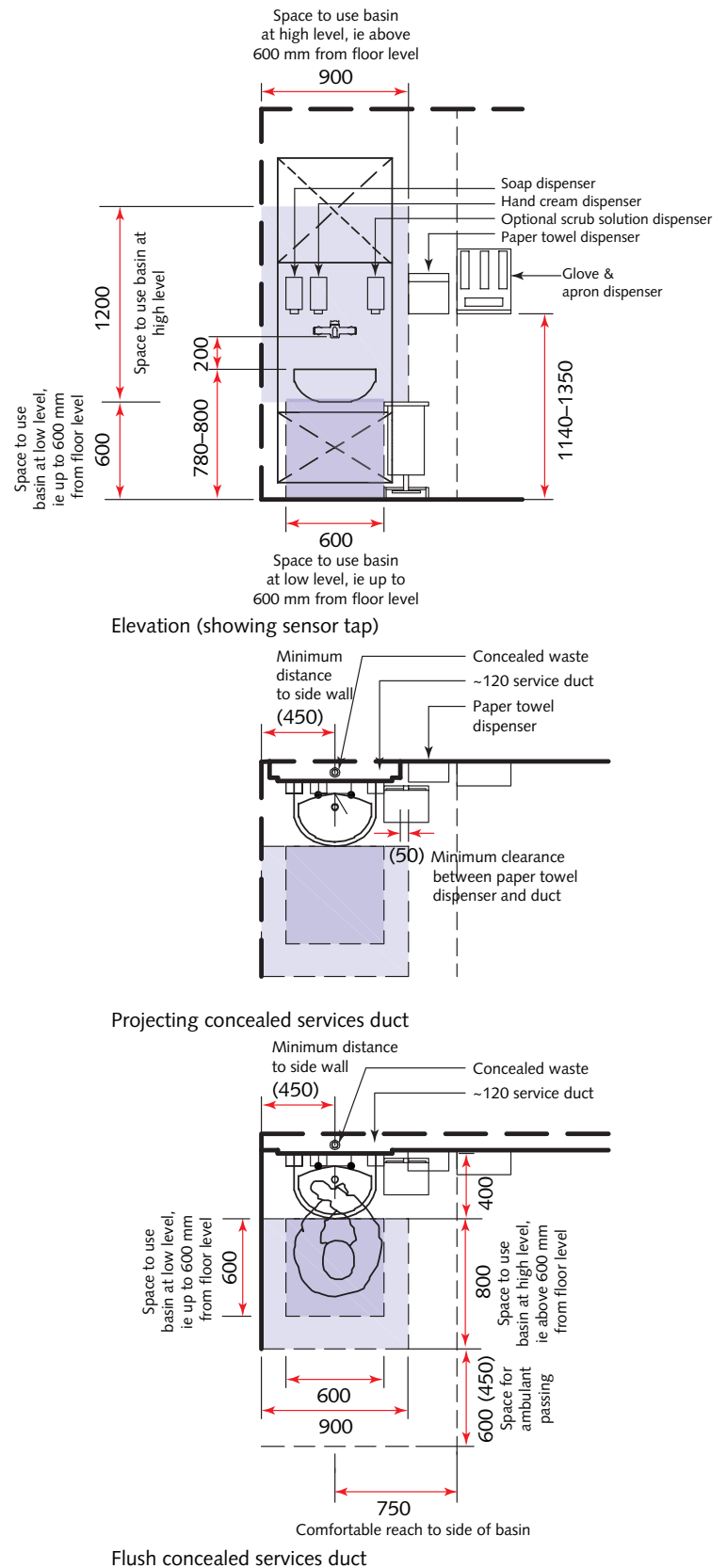

*Clinical workstation*

6.45 This ergonomic drawing (see Figure 55) shows the space requirements for a clinical workstation.

6.46 The clinical workstation is intended for accessing and updating patient records within a clinical environment. It should only be used for short periods of time.

Figure 55 Space requirements for a clinical workstation

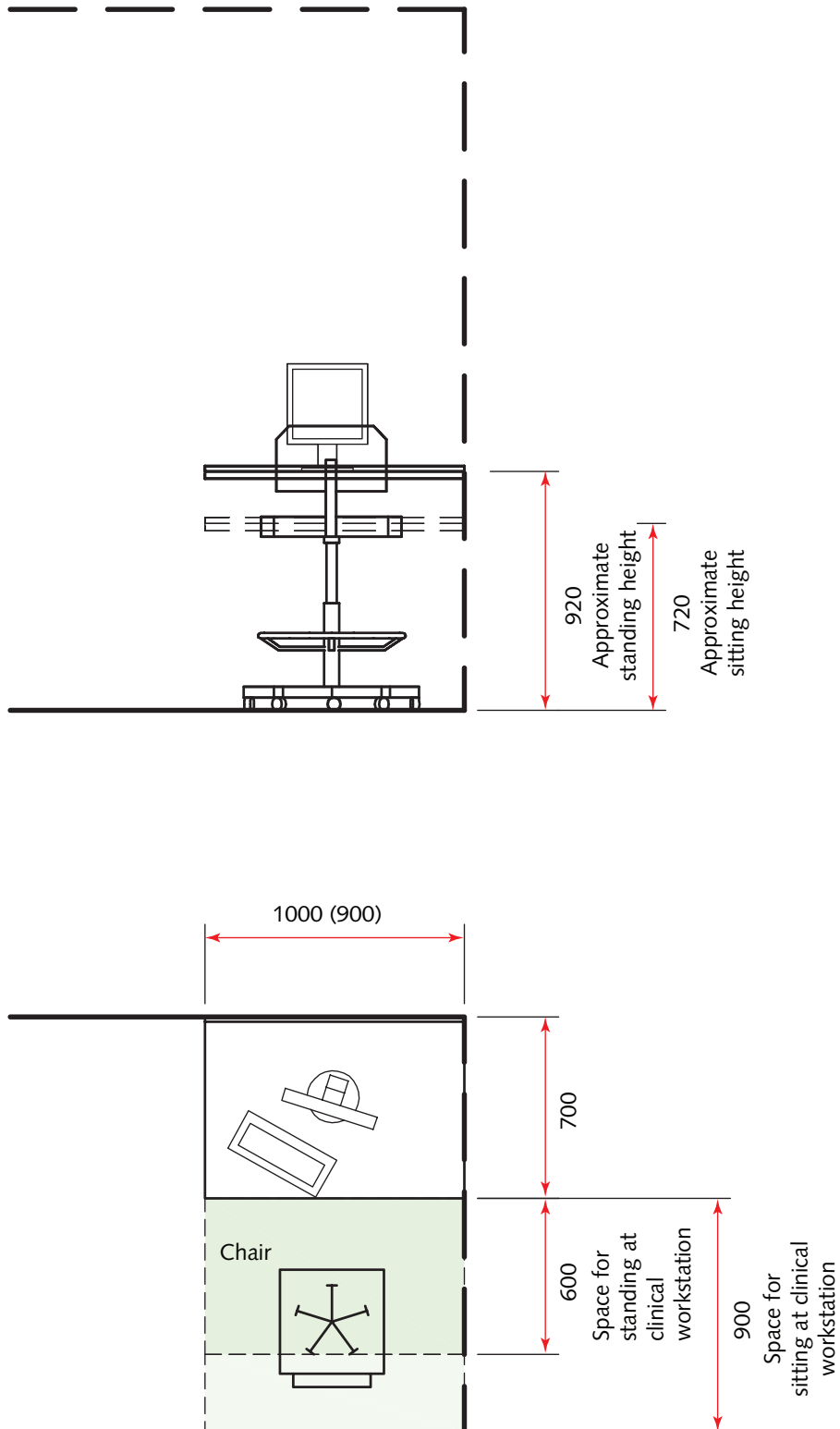

*Couch: double-sided access*

6.47 These ergonomic drawings (see Figure 56) show the space requirements for double-sided access to a three-section couch. The overall general space requirements for a three-section couch are the same as for a two-section couch.

6.48 Ceiling-mounted examination lights should be provided where double-sided couch access is required.

Figure 56 Space requirements for double-sided access to a three-section couch

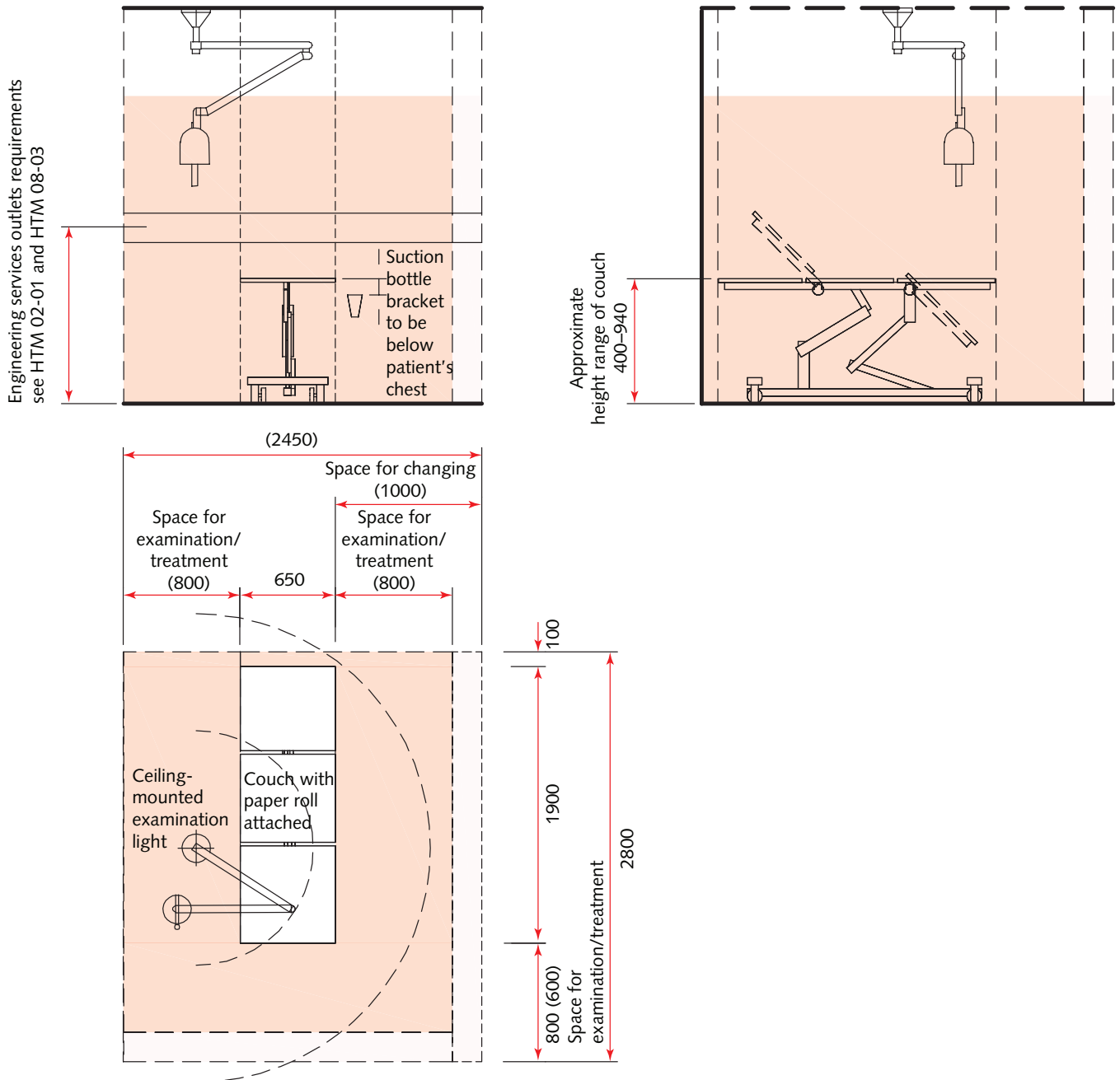

*Treatment chairs (various): double-sided access*

6.49 These ergonomic drawings (see Figure 57) show the space requirements for double-sided access to a variety of treatment chairs.

6.50 The reclining treatment/therapy chair provides the most flexible option for general examinations and treatments.

6.51 The reclining gynaecology chair may be used for general examinations and treatments or female internal examinations. A variety of attachments are available to assist internal examinations of females

including stirrups, leg supports or footrests. The use of the various methods is subject to local clinical and/or patient/client preferences.

6.52 The podiatry treatment chair incorporates separate leg supports, which may be adjusted independently of one another.

6.53 The activity space for the podiatry treatment chair assumes the examination light is attached to the podiatry trolley. The illustrated chair is mobile. Floor-mounted chairs are also available although these may reduce flexibility in room use.

Figure 57 Space requirements for double-sided access to a variety of treatment chairs

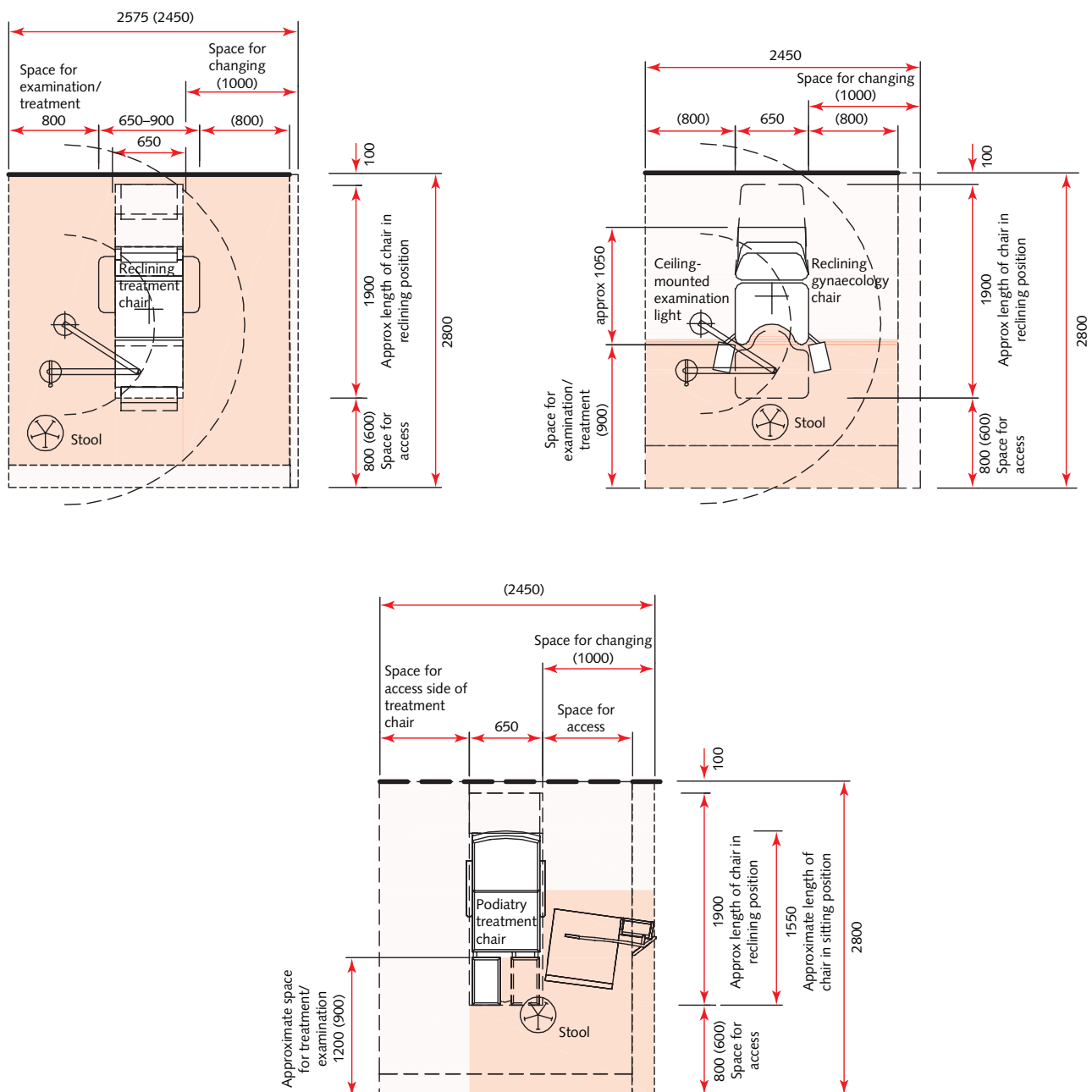

*Dressing and undressing: ambulant*

- 6.54 These ergonomic drawings (see Figure 58) show the space requirements for ambulant dressing and undressing.
- 6.55 An identical space provision is suitable for semi-ambulant users though it should be located adjacent to a seating area.

Figure 58 Space requirements for ambulant dressing and undressing

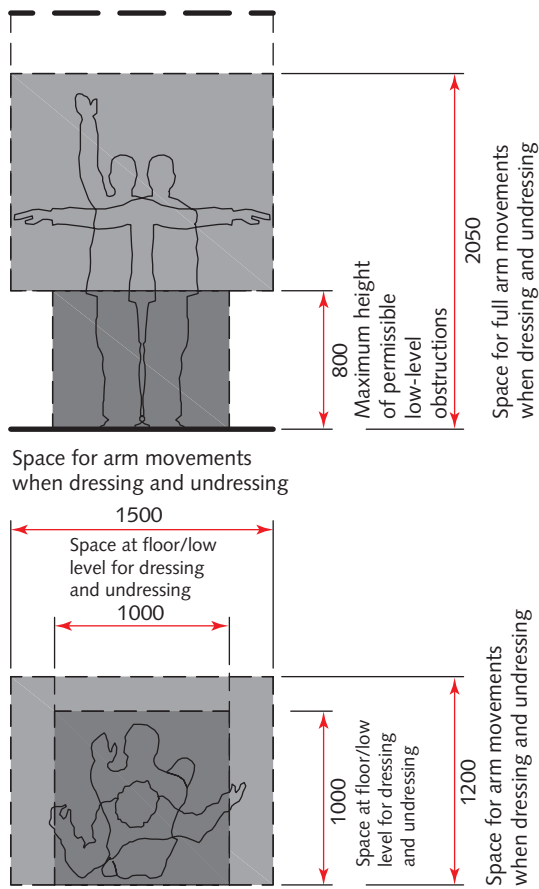

## 7 Generic clinical support spaces: Entrance, reception and waiting

### Children's play area

#### Room description

- 7.1 A safe and secure children's play area should be provided off all main waiting areas. Young children should be able to play in this area without disturbing patients/clients in the waiting area.
- 7.2 The location of the play area should facilitate easy and constant observation from the waiting area.
- 7.3 If possible, there should be access to an outside play area. Playground equipment and surfacing should comply with BS EN 1176-3, 1176-4 and 1177.
- 7.4 A clearly positioned sign should explain that children are welcome but not the clinic's responsibility.
- 7.5 No room layout has been provided. An allowance of 2 m<sup>2</sup> per child may be used for sizing children's play areas with a minimum recommended size of 6 m<sup>2</sup>.

### Infant feeding room

#### Room description

- 7.6 This room should allow a baby to be fed in privacy. It should be easily accessible from waiting areas or other areas expected to use the facility.
- 7.7 The fabric of the room should be sound absorbent.
- 7.8 It should include comfortable seating with washable covers and a hand-wash basin with non-touch taps.
- 7.9 Dimmable lighting and facilities for waste disposal should be provided.
- 7.10 Ceiling-mounted mobiles and facilities for playing music are recommended.
- 7.11 This room may be used for expressing breast milk, though expressed milk will be stored elsewhere.
- 7.12 No room layout has been provided.

### Information/resource centre

#### Room description

- 7.13 An information/resource area is a public space for the provision of healthcare-related information (both printed and via the Internet).
- 7.14 The space will contain a mixture of tables and chairs, and computer workstations.
- 7.15 It should be located close to an entrance or waiting area with access to beverage-making facilities.
- 7.16 It should be informal and welcoming in character.
- 7.17 It may include lockable cupboards, telephones and TV/video facilities.
- 7.18 The size of the area will depend on the number/type of users, range of display information, whether the area is staffed or not, and whether it is an enclosed space or open bay.
- 7.19 No room layout has been provided.

### Reception desk

#### Room description

- 7.20 A reception desk is similar to a staff communication base except that:
  - particular emphasis should be placed on the design of the desk to encourage patients and visitors to approach the base, including children;
  - additional consideration may be placed on providing privacy screens at the reception desk to assist with patient confidentiality;
  - a reception desk should be located so that it commands a clear, unobstructed view of the entrance and waiting area and access routes to clinical areas;
  - the 1200 mm working width will be required as more prolonged use will be expected.

- 7.21 As well as registering patients and making appointments, clinical administration work will also take place here. Public access to clinical areas will be controlled from the reception desk.
- 7.22 It is assumed patient records are electronic. The space allowance does not include space for notes trolleys.

## Waiting area

### Room description

- 7.23 Waiting areas should be close to the clinical or work area served and WC facilities. Main waiting areas should be adjacent to the main reception desk. Occupational therapists and/or ergonomists should be consulted on the selection of seating. Steps should be taken to ensure chairs cannot be used as potential weapons either by fixing chairs to the floor or to each other.
- 7.24 Locating waiting areas together may facilitate overspill arrangements. Large waiting areas may be broken down into smaller areas by the skilful arrangement of seating and by indoor planting.
- 7.25 The seating layout should be considered carefully to prevent confrontational situations (for example, by trying to avoid seats directly opposite each other). Seating should not be located immediately outside clinical rooms.
- 7.26 Natural light should be provided. Steps should be taken to prevent solar heat gain.
- 7.27 Doors from waiting areas into non-public access areas should be fitted with access control systems.
- 7.28 Background music and other entertainment facilities and enclosed notice boards may be provided.
- 7.29 No room layout has been provided. For sizing waiting areas, the following allowances may be used:
- 1.5 m<sup>2</sup> per ambulant place (that is, in a general chair);
  - 3 m<sup>2</sup> per wheelchair place.
- 7.30 For briefing purposes, waiting areas may be sized at 1.85–2.25 m<sup>2</sup> per place (see [Table 1 on page 68](#)). This allows for:
- 10% of waiting places to be suitable for people in wheelchairs;
  - a children's play area based on 10% of the number of main waiting places and sized at 2 m<sup>2</sup> per child (with a minimum space for three children).
- 7.31 Where there is a higher percentage of children and/or people in wheelchairs, this allowance will need to increase to 2–3 m<sup>2</sup> per place. The allowance does not include:
- WCs;
  - optional spaces such as self-registrations points, vending machines, nappy changing rooms, baby feeding rooms and telephone booths.



Table 1 Waiting area sizes

<b>Waiting area: 10 places</b>					
<b>Component spaces</b>	<b>% of users</b>	<b>Qty</b>	<b>Unit area allowance (m<sup>2</sup>)</b>	<b>Total area (m<sup>2</sup>)</b>	<b>Waiting area allowance (m<sup>2</sup>)</b>
Ambulant places	90%	9	1.5	13.5	
Wheelchair places	10%	1	3	3	
Children's play area (no. of children)	10%	3	2	6	
<b>Net allowance</b>				<b>22.5</b>	<b>2.25 per place</b>
<b>Waiting area: 20 places</b>					
<b>Component spaces</b>	<b>% of users</b>	<b>Qty</b>	<b>Unit area allowance (m<sup>2</sup>)</b>	<b>Total area (m<sup>2</sup>)</b>	<b>Waiting area allowance (m<sup>2</sup>)</b>
Ambulant places	90%	18	1.5	27	
Wheelchair places	10%	2	3	6	
Children's play area (no. of children)	10%	3	2	6	
<b>Net allowance</b>				<b>39</b>	<b>1.95 per place</b>
<b>Waiting area: 30 places</b>					
	<b>% of users</b>	<b>Qty</b>	<b>Unit area allowance (m<sup>2</sup>)</b>	<b>Total area (m<sup>2</sup>)</b>	<b>Waiting area allowance (m<sup>2</sup>)</b>
Ambulant places	90%	27	1.5	40.5	
Wheelchair places	10%	3	3	9	
Children's play area (no. of children)	10%	3	2	6	
<b>Net allowance</b>				<b>55.5</b>	<b>1.85 per place</b>
<b>Waiting area: 40 places</b>					
	<b>% of users</b>	<b>Qty</b>	<b>Unit area allowance (m<sup>2</sup>)</b>	<b>Total area (m<sup>2</sup>)</b>	<b>Waiting area allowance (m<sup>2</sup>)</b>
Ambulant places	90%	36	1.5	54	
Wheelchair places	10%	4	3	12	
Children's play area (no. of children)	10%	4	2	8	
<b>Net allowance</b>				<b>74</b>	<b>1.85 per place</b>

## 8 Generic clinical support spaces: Utility

### Clean supply room

#### Room description and layout

- 8.1 This room is effectively a store for sterile supplies and consumables. Empty supplies trolleys and dressings/instruments trolleys will be held here and restocked for distribution to wards and clinical areas. It is not for storing medicines. Where clean supply rooms are used, and medicines storage/preparation is required outside clinical rooms, each clean supply room should be supported by a series of medicine store/preparation rooms.
- 8.2 Two room layouts have been provided (see [Figures 59 and 60](#)).
- 8.3 The width of both room layouts is just about acceptable to include racking and/or supplies trolleys along the centre of the room; this is on the understanding that the tall modular storage cabinets are accessed from the side.
- 8.4 Option 1 is slightly wider allowing the storage units to be arranged so that an additional base cupboard and wall cupboard can be accommodated.
- 8.5 The illustrated space requirements for accessing modular base and upper cabinets is based on space to access standard cupboards, not using baskets or trays. However, adequate space is available for side access to baskets or trays.
- 8.6 The illustrated space requirements for accessing modular racking is based on space to access open shelves.

Figure 60 Clean supply room (option 2)

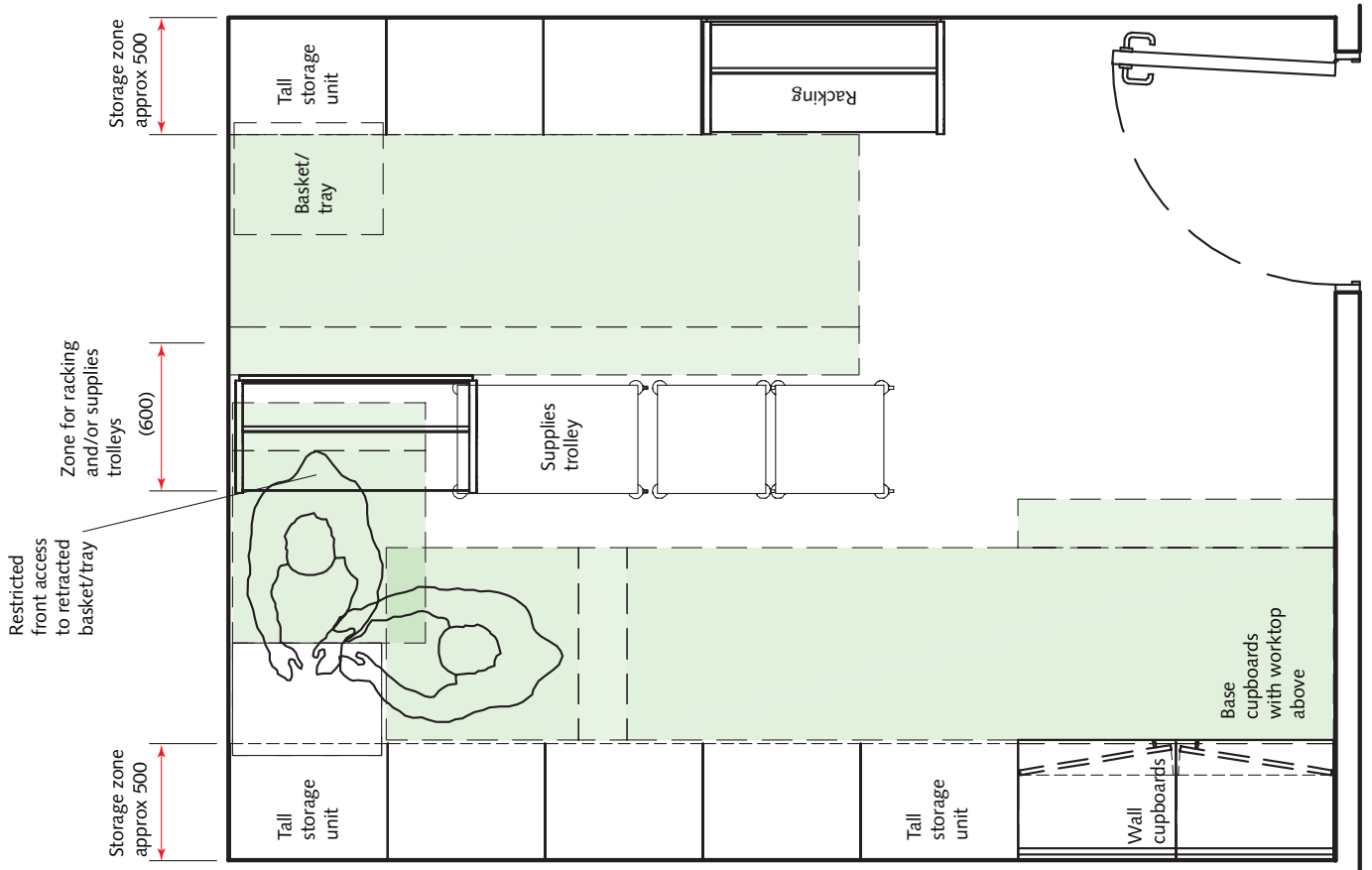

Figure 59 Clean supply room (option 1)



**Ergonomic drawings**

*Tall modular storage cabinets*

8.7 Tall modular storage cabinets are generally constructed to accommodate 600 × 400 mm baskets and trays to provide a variety of fixed or mobile storage options. The cabinets may be constructed to have either 400 mm or 600 mm wide facing baskets or trays.

8.8 This ergonomic drawing (see Figure 61) shows the space requirements to access a cabinet with 600 mm wide baskets/trays.

8.9 Tall modular storage cabinets are generally 2100 mm high; the top shelves are higher than those recommended for normal fixed storage units because the baskets/trays can be angled to enable their contents to be accessed.

Figure 61 Space requirements to access tall modular storage cabinets with 600 mm wide baskets/trays

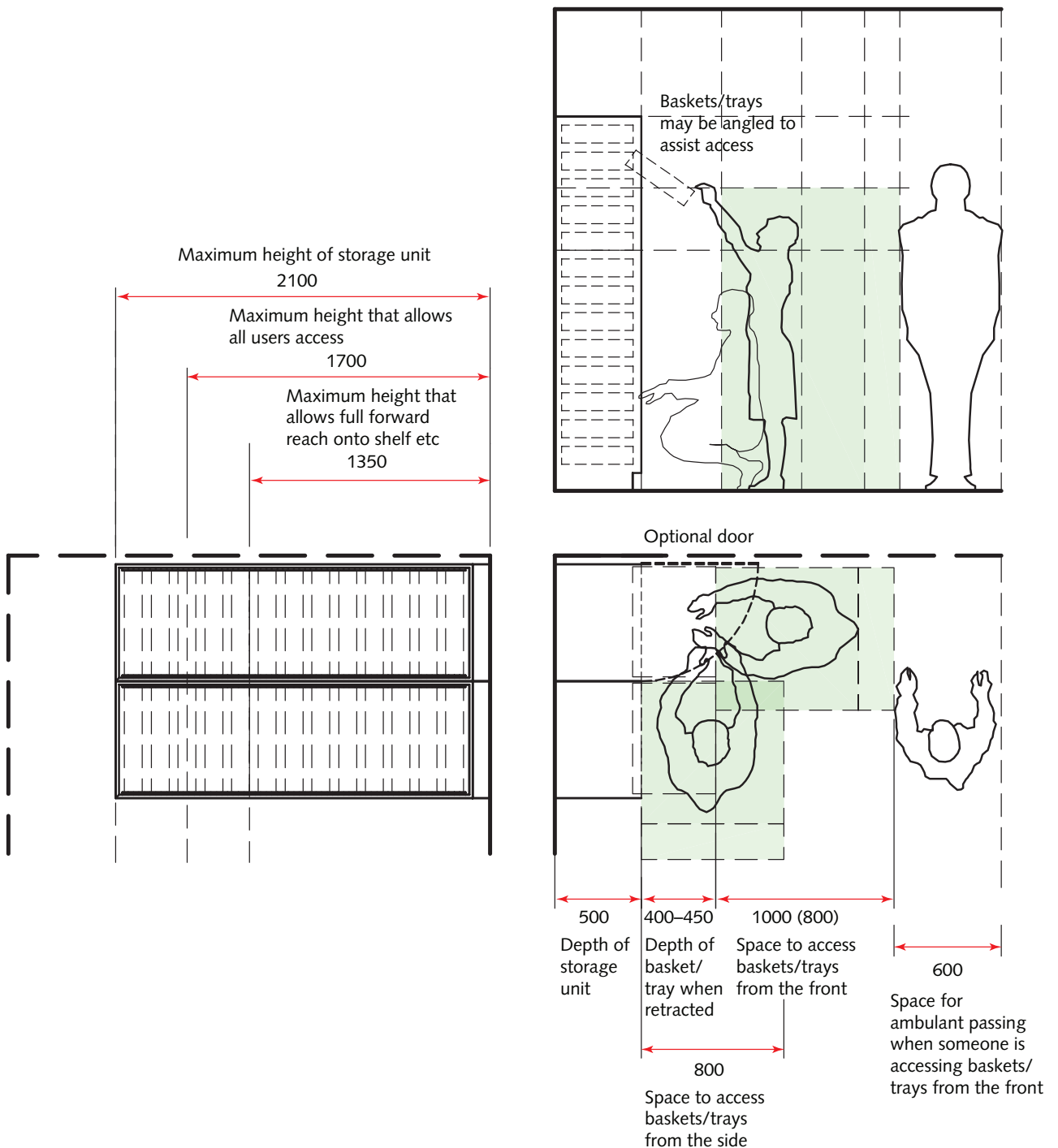

Standard base and wall cupboards

8.10 This ergonomic drawing (see Figure 62) shows the space requirements to access standard, floor mounted, base and wall cupboards. Where

worktops or other obstructions project more than 500 mm, the reach dimensions illustrated relate to the front edge of the wall cupboard (that is, reaching into the cupboard would be difficult).

Figure 62 Space requirements to access standard, floor mounted base and wall cupboards

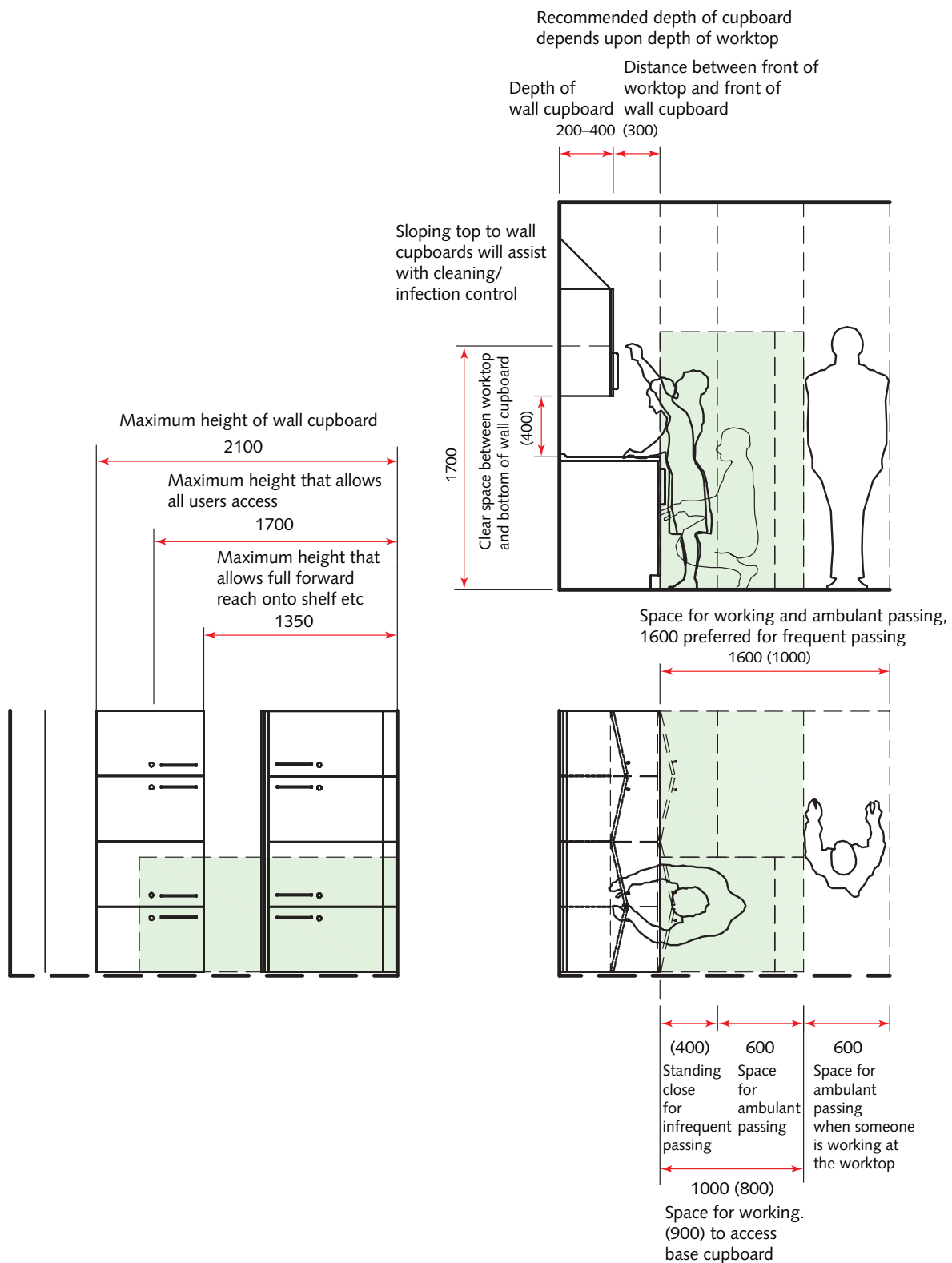

*Open shelves*

- 8.11 This ergonomic drawing (see Figure 63) shows the space requirements to access high open shelves. The same principles apply to modular open racking.
- 8.12 The height and dimensions of the shelves should relate to the size and weight of items stored and frequency with which they will be handled.
- 8.13 Frequently used items should be stored on shelves positioned at 300–1500 mm above floor level. Frequently used small items should be stored on shallow shelves at or near worktop height (that is, 900 mm). Heavy object should be stored below worktop height.
- 8.14 The shelf intervals (that is, space between two shelves) should at least equal the depth of the shelves.
- 8.15 The illustrated access space is for general use (with shelves up to 450 mm deep). Where items are large or heavy the access space may need to increase by up to 500 mm.
- 8.16 Where heavy or otherwise difficult to move items are stored at the end of shelves a 200 mm clearance is required to the side of the object for safe access.

Figure 63 Space requirements to access high open shelves

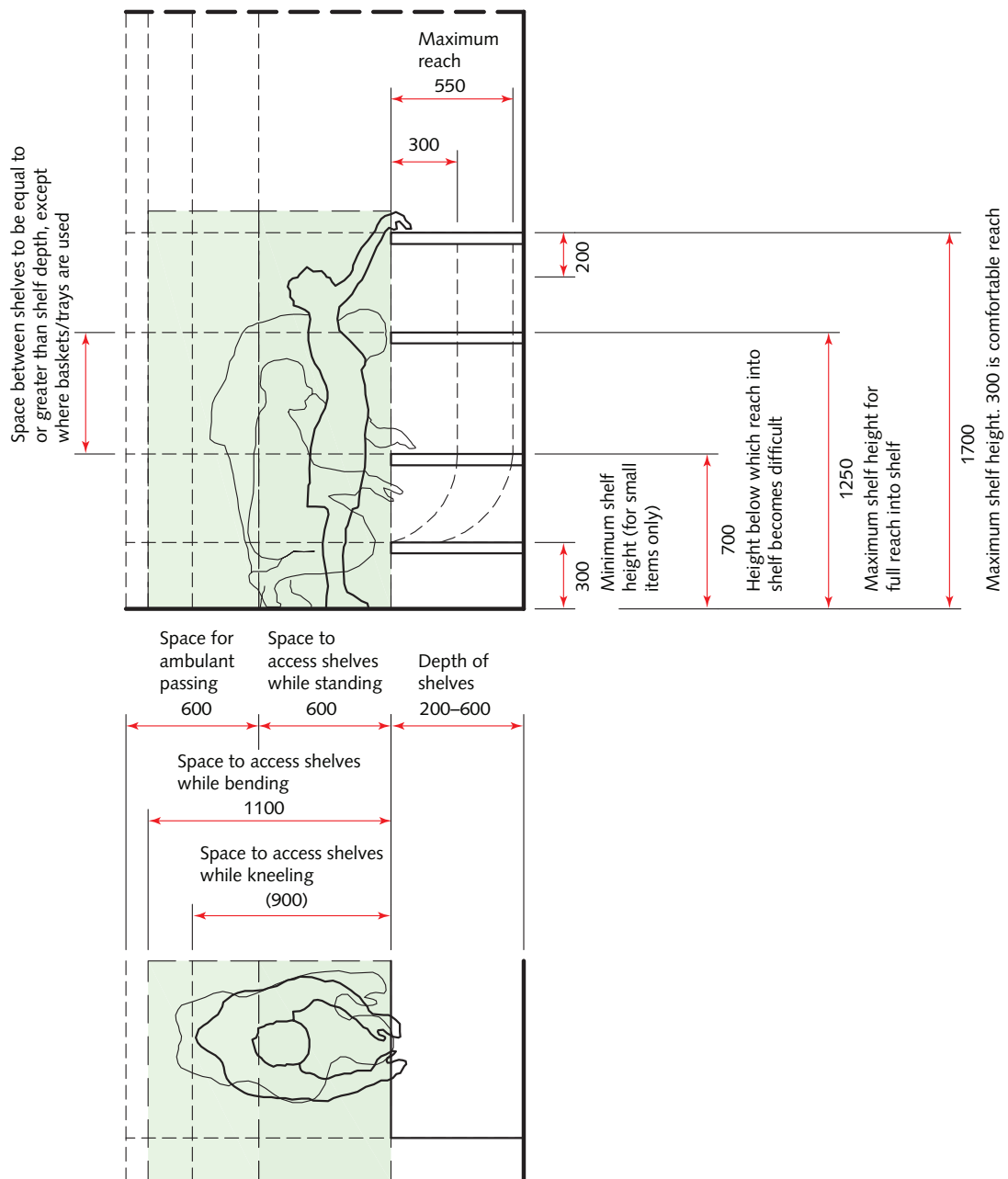

## Clean utility room without controlled drugs cupboard

### Room description and layout

8.17 This room is for storing sterile supplies and consumables, excluding infusion fluids, and for storing and preparing medicines, excluding controlled drugs.

8.18 Empty supplies trolleys and dressings/instruments trolleys will be held here and restocked for distribution to wards and clinical areas.

8.19 The illustrated space requirements (see Figure 64) for accessing modular base and upper cabinets is based on space to access standard cupboards, not using baskets or trays. However, adequate space is available for side access to baskets or trays.

Figure 64 Space requirements for accessing modular base and upper cabinets

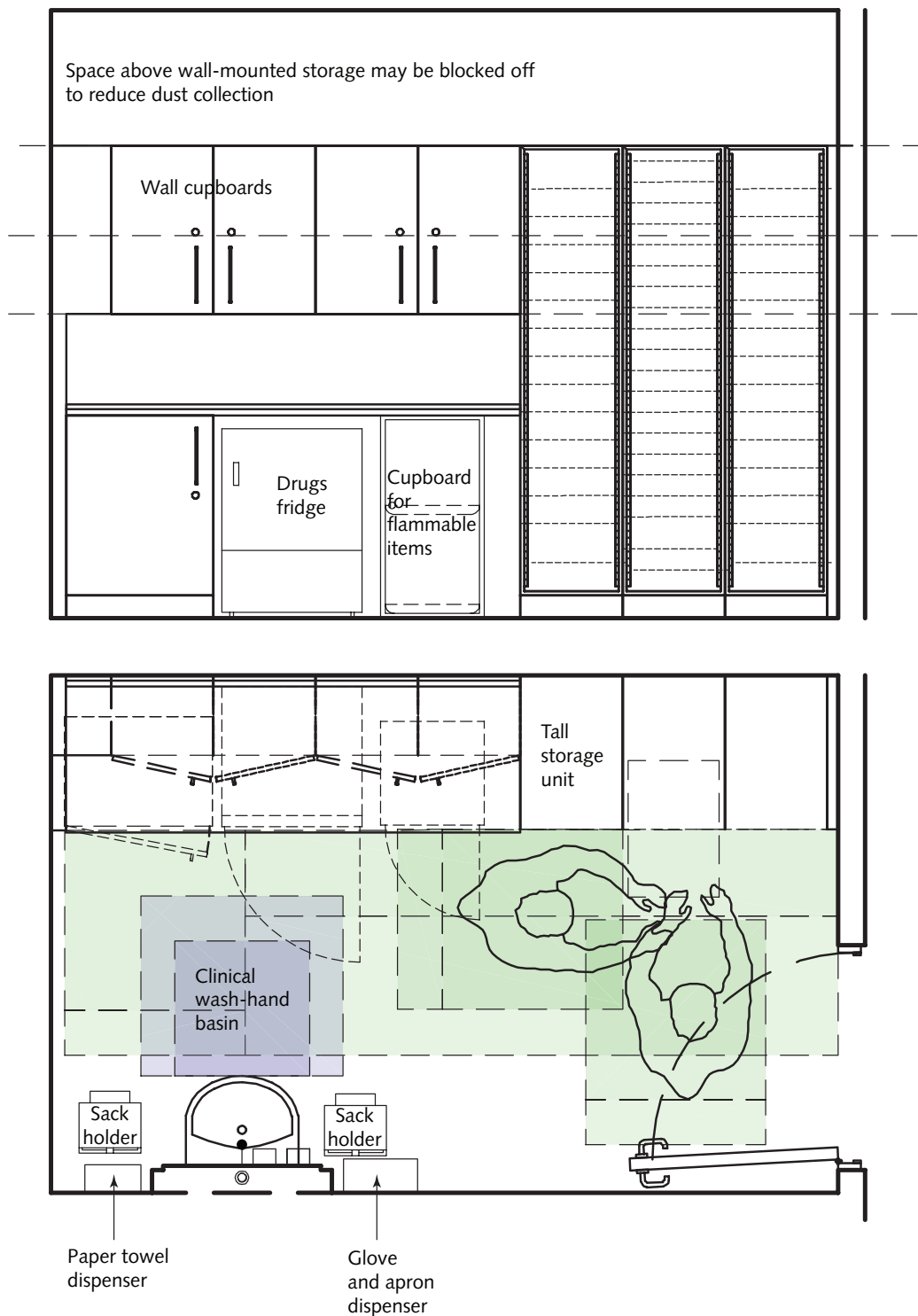

**Ergonomic drawings**

*Tall modular storage cabinets*

8.20 Tall modular storage cabinets are generally constructed to accommodate 600 × 400 mm baskets and trays to provide a variety of fixed or mobile storage options. The cabinets may be constructed to have either 400 mm or 600 mm wide facing baskets or trays.

8.21 This ergonomic drawing (see Figure 65) shows the space requirements to access a cabinet with 600 mm wide baskets/trays.

8.22 Tall modular storage cabinets are generally 2100 mm high; the top shelves are higher than those recommended for normal fixed storage units because the baskets/trays can be angled to enable their contents to be accessed.

Figure 65 Space requirements to access tall modular storage cabinets with 600 mm wide baskets/trays

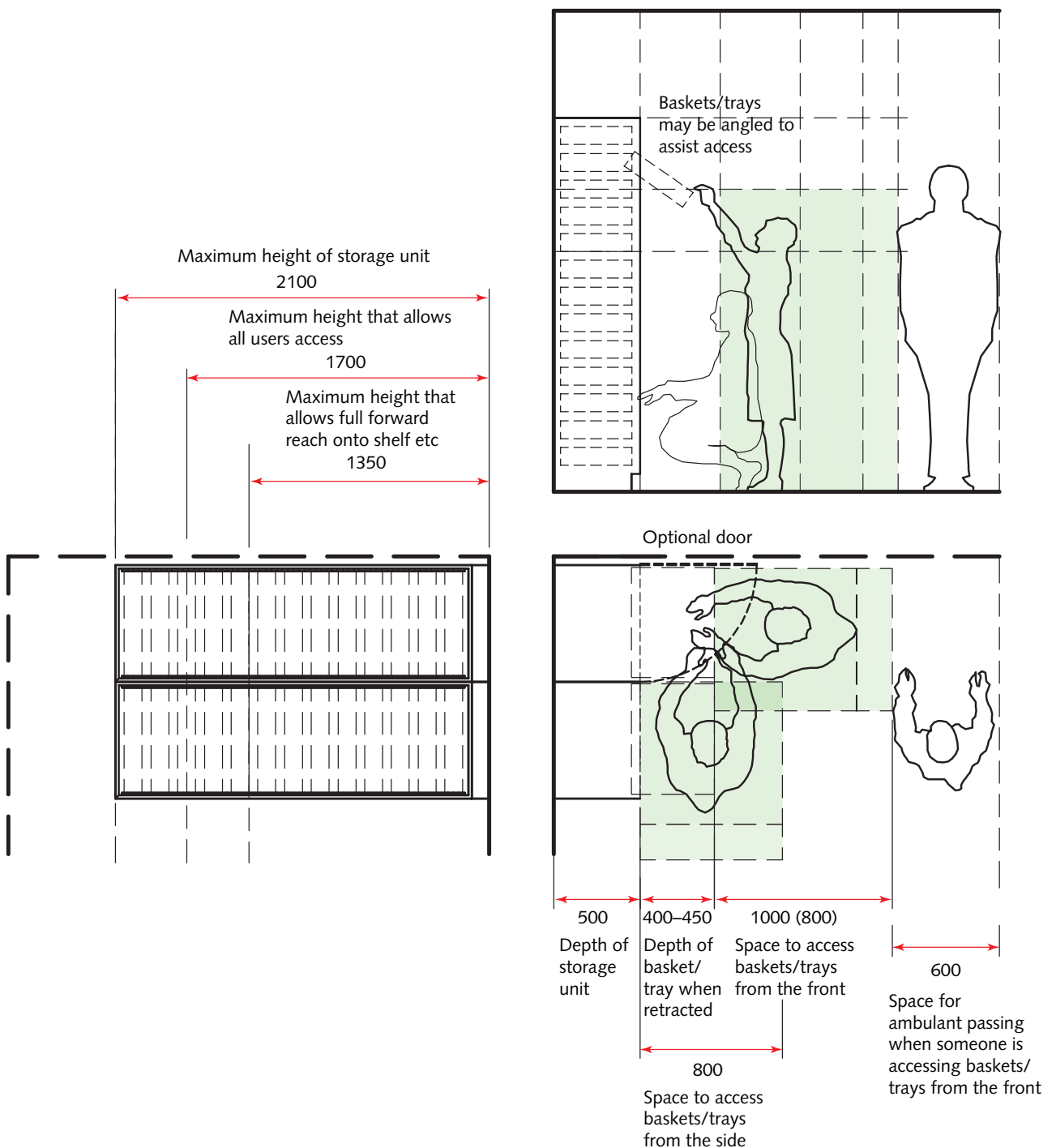



Standard base and wall cupboards

8.23 This ergonomic drawing (see Figure 66) shows the space requirements to access standard, floor mounted, base and wall cupboards. Where

worktops or other obstructions project more than 500 mm, the reach dimensions illustrated relate to the front edge of the wall cupboard (that is, reaching into the cupboard would be difficult).

Figure 66 Space requirements to access standard, floor mounted base and wall cupboards

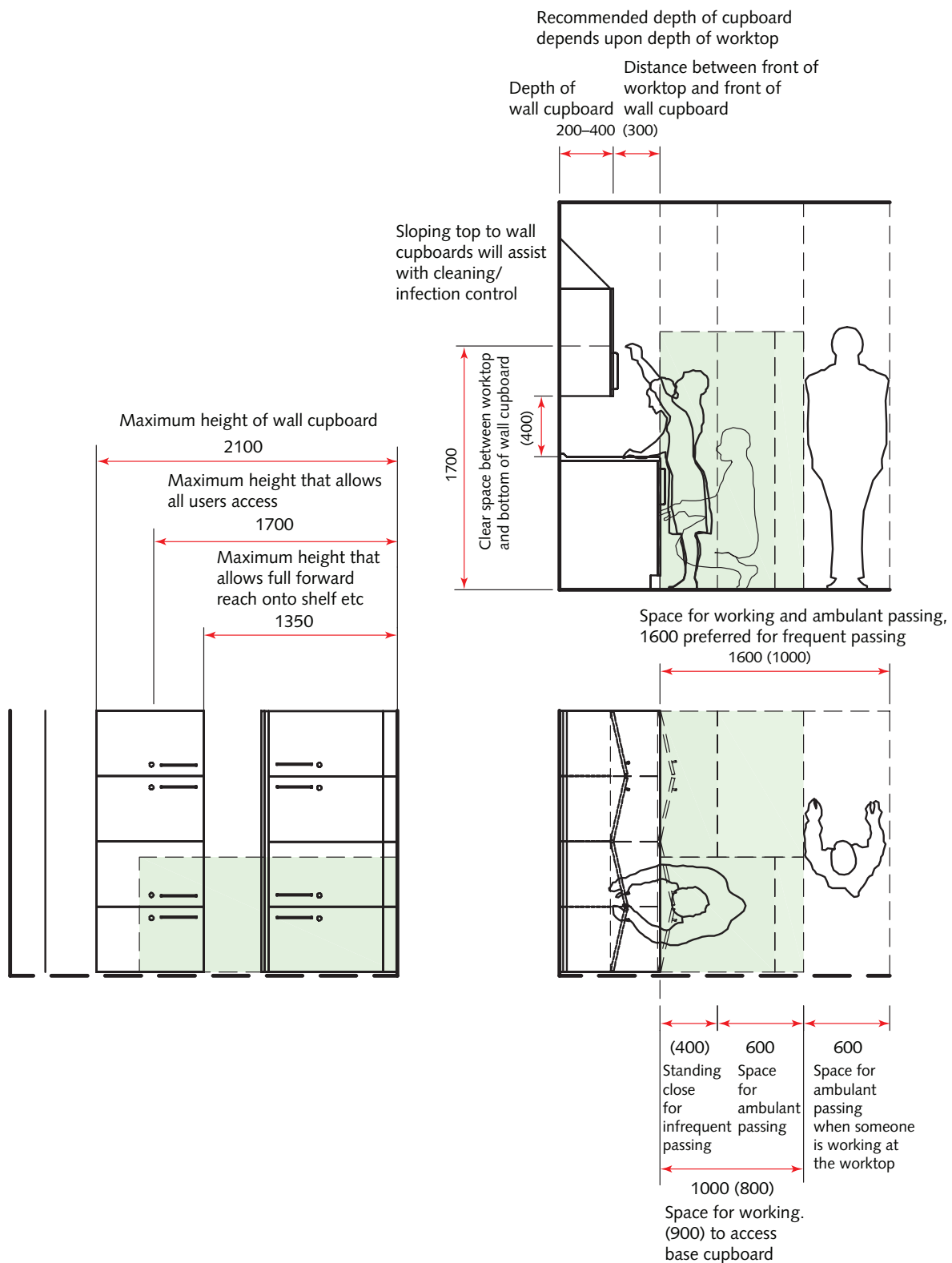

*Clinical wash-hand basin*

- 8.24 These ergonomic drawings (see Figure 67) show the space requirements for standing use of a clinical wash-hand basin assembly. For seated use, the basin will need to be lowered.
- 8.25 The basin should be fitted with non-touch taps.
- 8.26 The recommended fixing height of a lever tap on a clinical wash-hand basin is 1095 mm. Where a lever tap is used, the fixing height of the dispensers should be chosen to reduce any possible conflicts in use.
- 8.27 The illustrated clinical wash-hand basin projects 400 mm from the back panel or wall. However, clinical wash-hand basins may vary from 350 to 500 mm projection. Where basins deeper than 400 mm are used, the impact on/from other components and/or activities undertaken within any space should be considered when evaluating any room layout.
- 8.28 The glove and apron dispenser illustrated is a combined unit; this is considered the most compact solution although separate units may also be used. Even the most compact unit cannot practically be located within comfortable reach of the basin; it should, however, be conveniently located within the room.
- 8.29 The ergonomic advice for the height of horizontal elbow operated lever taps is based on the following data:  
 “Elbow height for shod, slightly bent posture (as when leaning forward) for 50%ile UK male = 1134 mm, for female 1049 mm. 1090 mm is considered the best compromise for an elbow height for both male and female use. The ergonomic advice for the height of a lever tap is 75 mm below elbow height giving a figure height of approx 1015 mm.”
- 8.30 Lever taps are not illustrated.
- 8.31 For detailed information on basins, see Health Building Note 00-10 Part C – ‘Sanitary assemblies’.

Figure 67 Space requirements for standing use of clinical wash-hand basin assembly

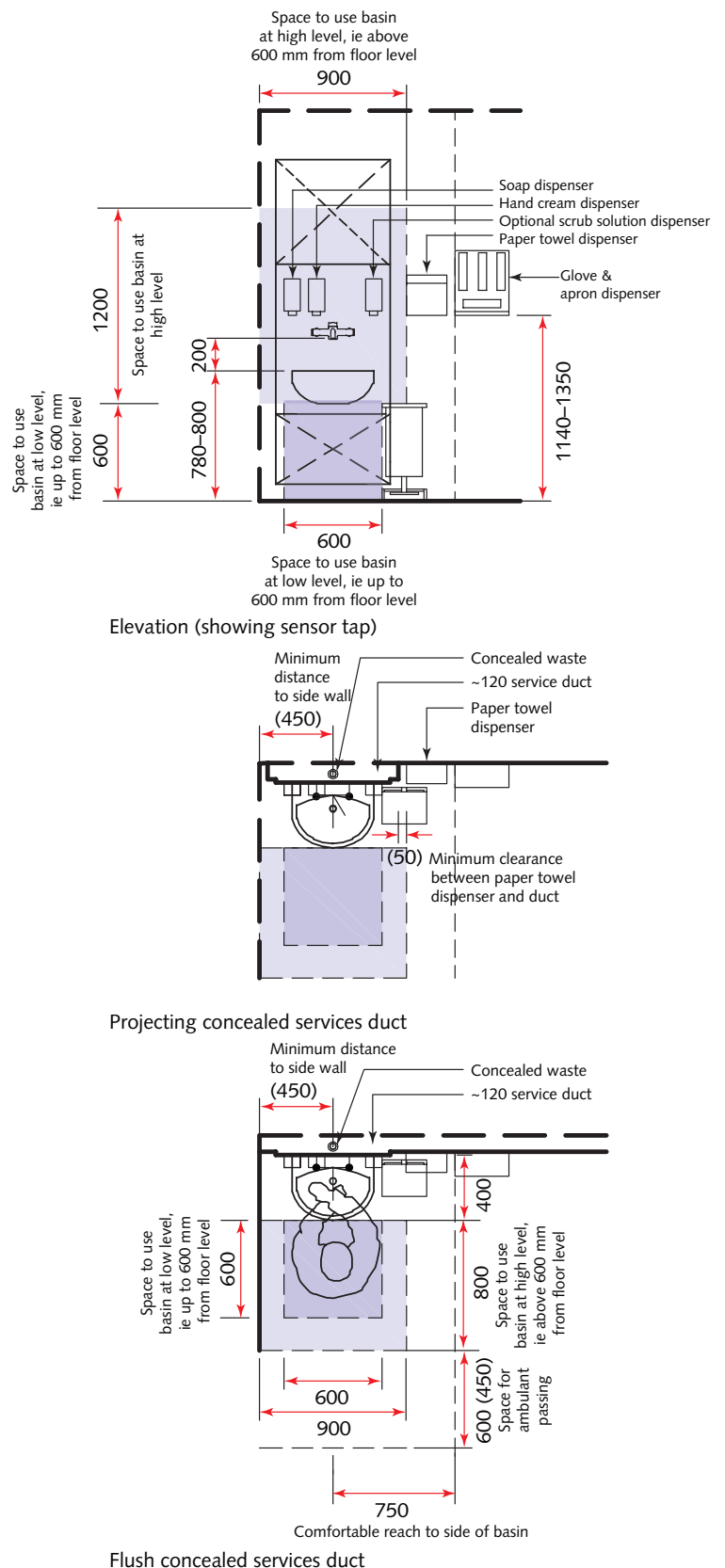

## Clean utility room

### Room description and layout

- 8.32 This room is for storing sterile supplies and consumables, including infusion fluids, and for storing and preparing medicines, including controlled drugs.
- 8.33 Empty supplies trolleys and dressings/instruments trolleys will be held here and restocked for distribution to wards and clinical areas.
- 8.34 Two room layouts have been provided (see [Figures 68 and 69](#)).
- 8.35 Both layouts provide limited access to the tall storage units from the front (i.e. it is assumed access will be from the side). However, option 1 is slightly wider allowing the tall storage units to be arranged so that the room can accommodate an extra storage unit and racking as opposed to just mobile trolleys down the centre of the room.
- 8.36 The illustrated space requirements for accessing modular base and upper cabinets is based on space to access standard cupboards, not using baskets or trays. However, adequate space is available for side access to baskets or trays.
- 8.37 The illustrated space requirements for accessing modular racking is based on space to access open shelves.

Figure 69 Clean supply room (option 2)

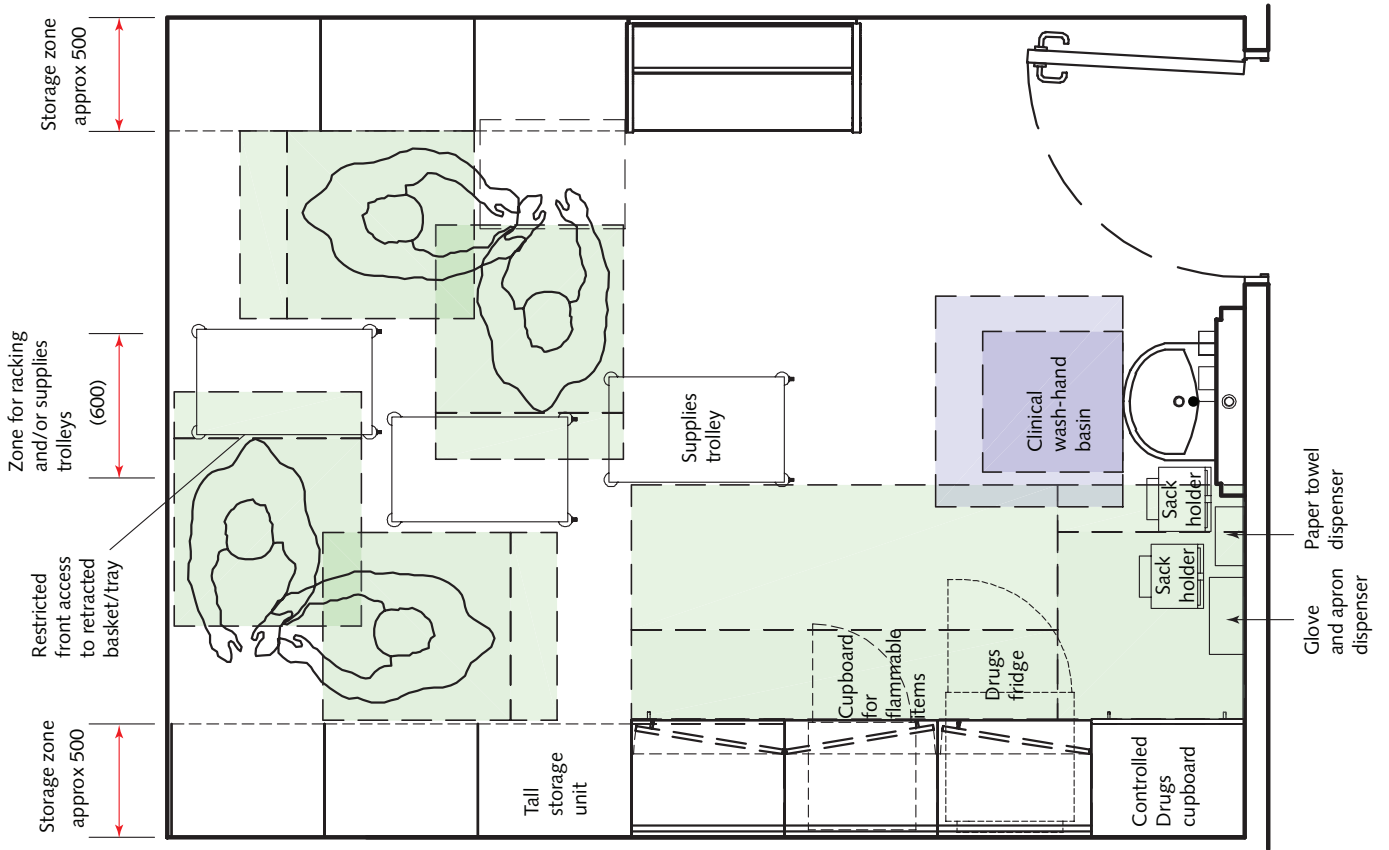
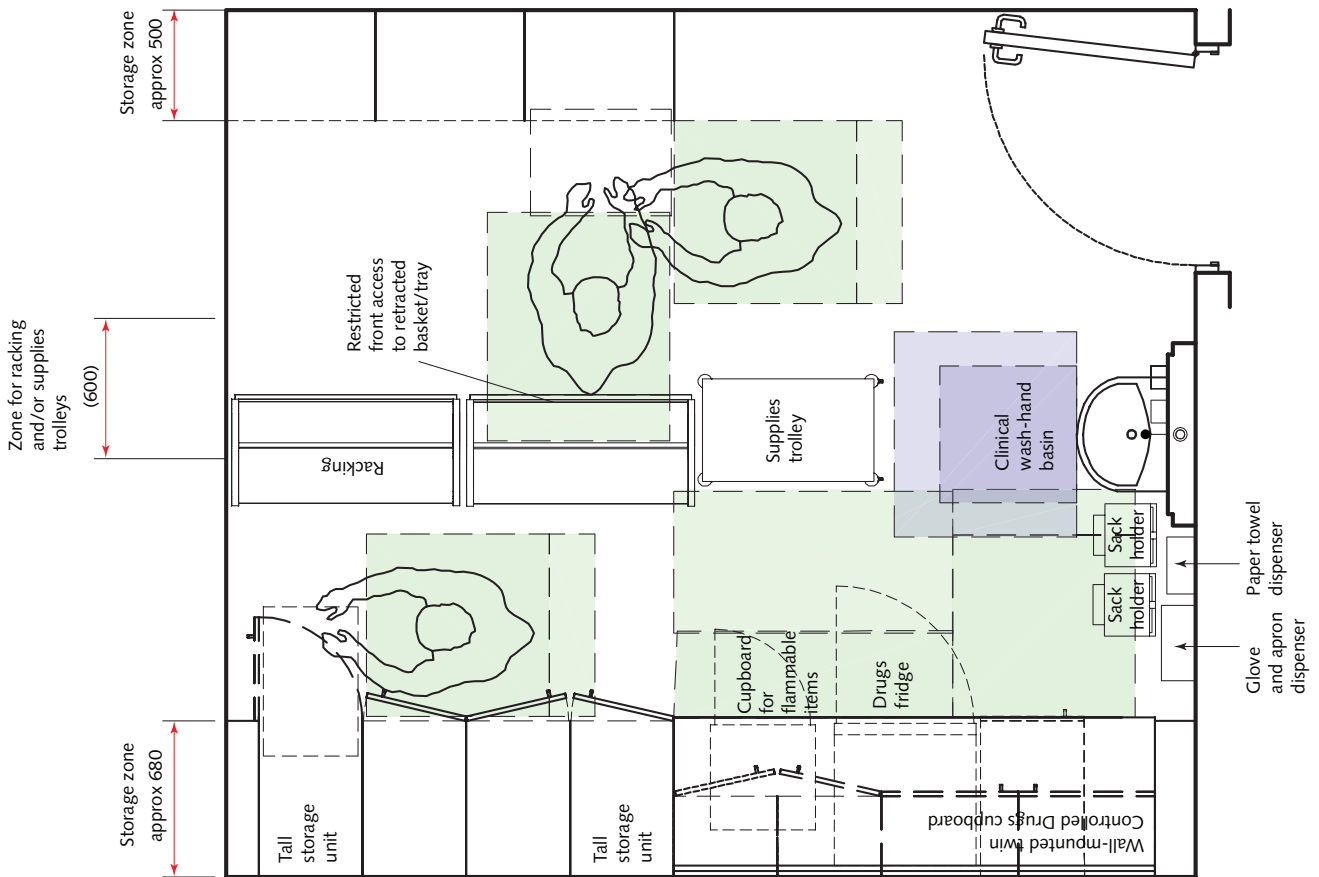

Figure 68 Clean supply room (option 1)



## Ergonomic drawings

### Clinical wash-hand basin

8.38 These ergonomic drawings (see Figure 70) show the space requirements for standing use of a clinical wash-hand basin assembly. For seated use, the basin will need to be lowered.

8.39 The basin should be fitted with non-touch taps.

8.40 The recommended fixing height of a lever tap on a clinical wash-hand basin is 1095 mm. Where a lever tap is used, the fixing height of the dispensers should be chosen to reduce any possible conflicts in use.

8.41 The illustrated clinical wash-hand basin projects 400 mm from the back panel or wall. However, clinical wash-hand basins may vary from 350 to 500 mm projection. Where basins deeper than 400 mm are used, the impact on/from other components and/or activities undertaken within any space should be considered when evaluating any room layout.

8.42 The glove and apron dispenser illustrated is a combined unit; this is considered the most compact solution although separate units may also be used. Even the most compact unit cannot practically be located within comfortable reach of the basin; it should, however, be conveniently located within the room.

8.43 The ergonomic advice for the height of horizontal elbow operated lever taps is based on the following data:

“Elbow height for shod, slightly bent posture (as when leaning forward) for 50%ile UK male = 1134 mm, for female 1049 mm. 1090 mm is considered the best compromise for an elbow height for both male and female use. The ergonomic advice for the height of a lever tap is 75 mm below elbow height giving a figure height of approx 1015 mm.”

8.44 Lever taps are not illustrated.

8.45 For detailed information on basins, see Health Building Note 00-10 Part C – ‘Sanitary assemblies’.

Figure 70 Space requirements for standing use of a clinical wash-hand basin assembly

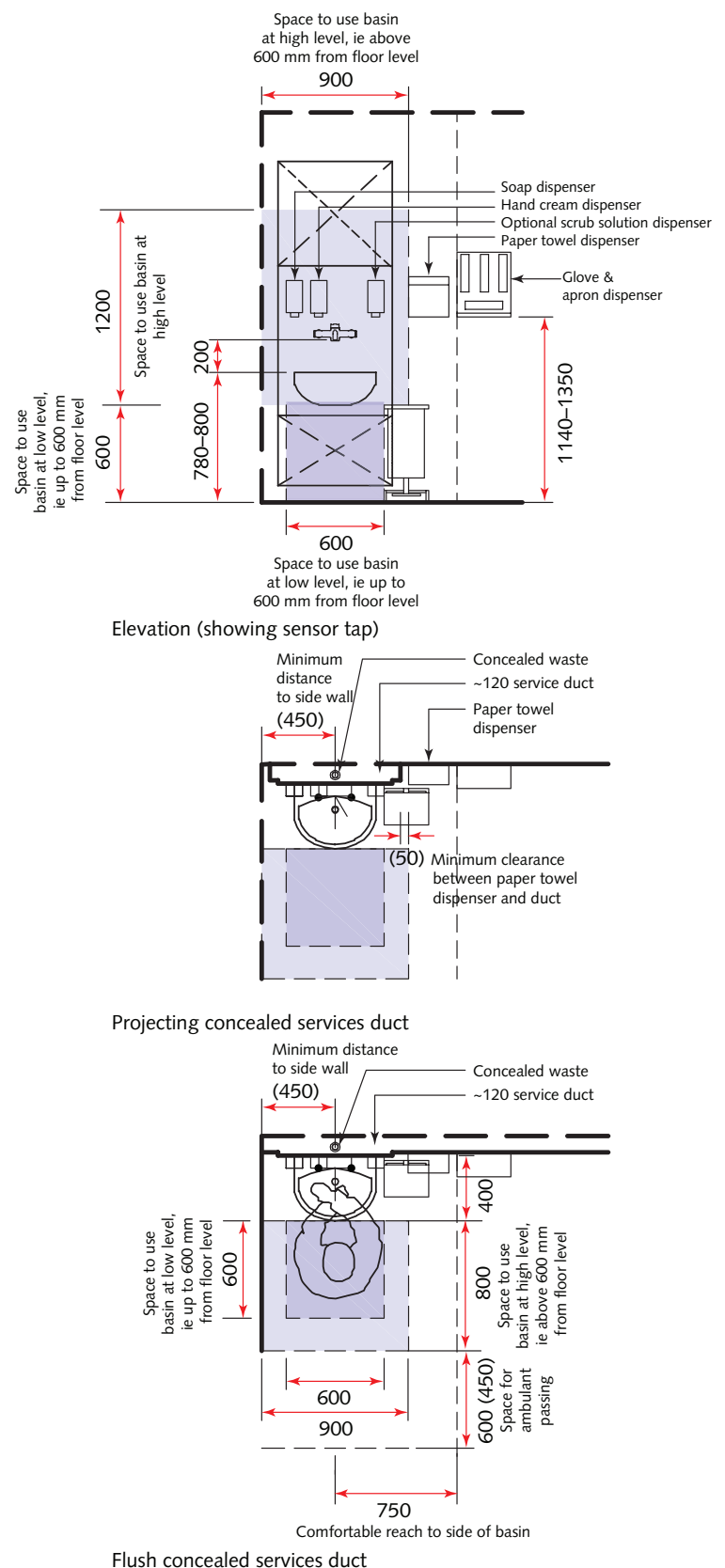

*Tall modular storage cabinets*

8.46 Tall modular storage cabinets are generally constructed to accommodate 600 × 400 mm baskets and trays to provide a variety of fixed or mobile storage options. The cabinets may be constructed to have either 400 mm or 600 mm wide facing baskets or trays.

8.47 This ergonomic drawing (see Figure 71) shows the space requirements to access a cabinet with 600 mm wide baskets/trays.

8.48 Tall modular storage cabinets are generally 2100 mm high; the top shelves are higher than those recommended for normal fixed storage units because the baskets/trays can be angled to enable their contents to be accessed.

Figure 71 Space requirements to access tall modular storage cabinets with 600 mm wide baskets/trays

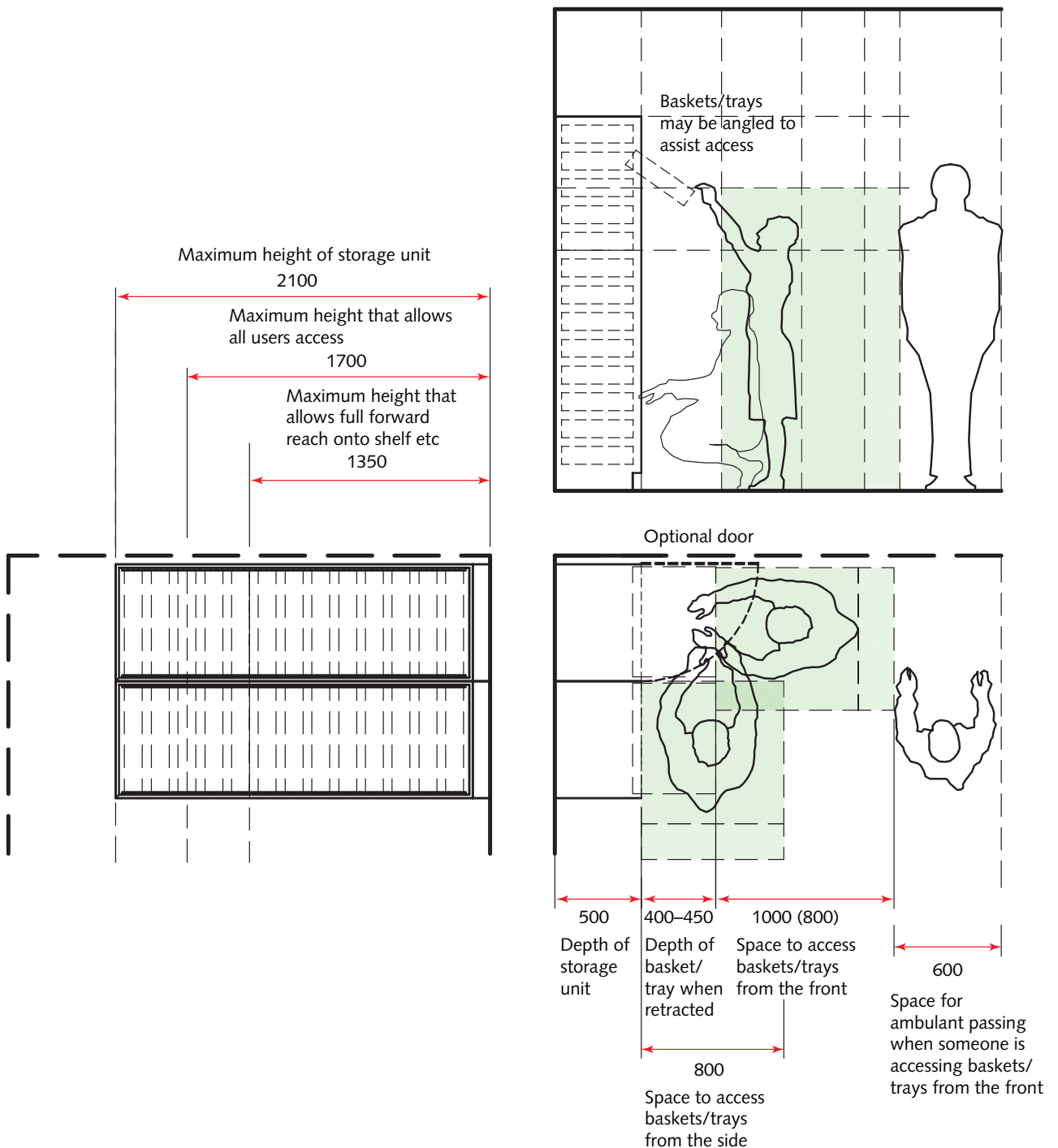

Standard base and wall cupboards

8.49 This ergonomic drawing (see Figure 72) shows the space requirements to access standard, floor mounted, base and wall cupboards. Where

worktops or other obstructions project more than 500 mm, the reach dimensions illustrated relate to the front edge of the wall cupboard (that is, reaching into the cupboard would be difficult).

Figure 72 Space requirements to access standard, floor mounted base and wall cupboards

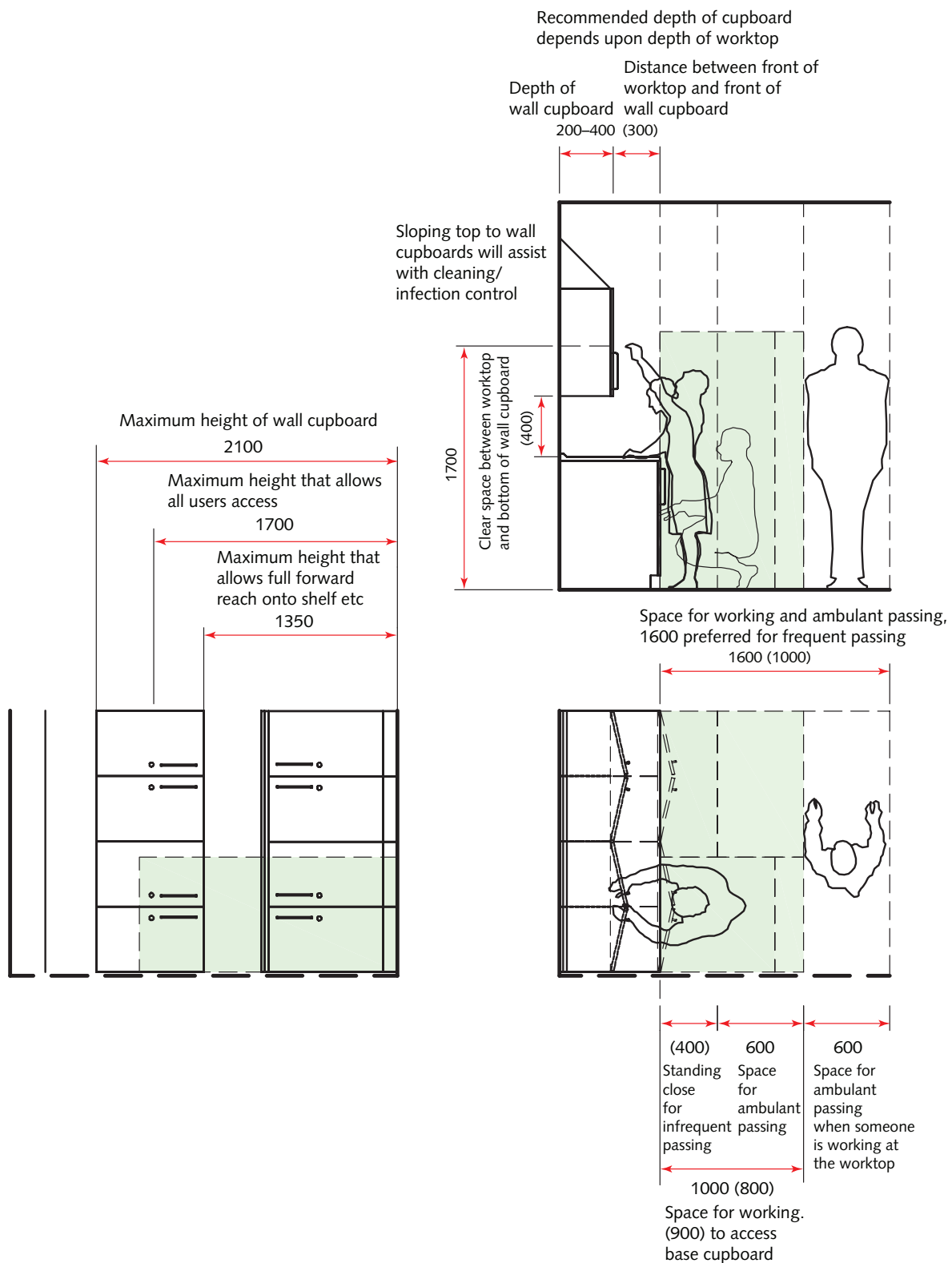

*Open shelves*

- 8.50 This ergonomic drawing (see Figure 73) shows the space requirements to access high open shelves. The same principles apply to modular open racking.
- 8.51 The height and dimensions of the shelves should relate to the size and weight of items stored and frequency with which they will be handled.
- 8.52 Frequently used items should be stored on shelves positioned at 300–1500 mm above floor level. Frequently used small items should be stored on shallow shelves at or near worktop height (that is, 900 mm). Heavy object should be stored below worktop height.

- 8.53 The shelf intervals (that is, space between two shelves) should at least equal the depth of the shelves.
- 8.54 The illustrated access space is for general use (with shelves up to 450 mm deep). Where items are large or heavy the access space may need to increase by up to 500 mm.
- 8.55 Where heavy or otherwise difficult to move items are stored at the end of shelves a 200 mm clearance is required to the side of the object for safe access.

Figure 73 Space requirements to access high open shelves

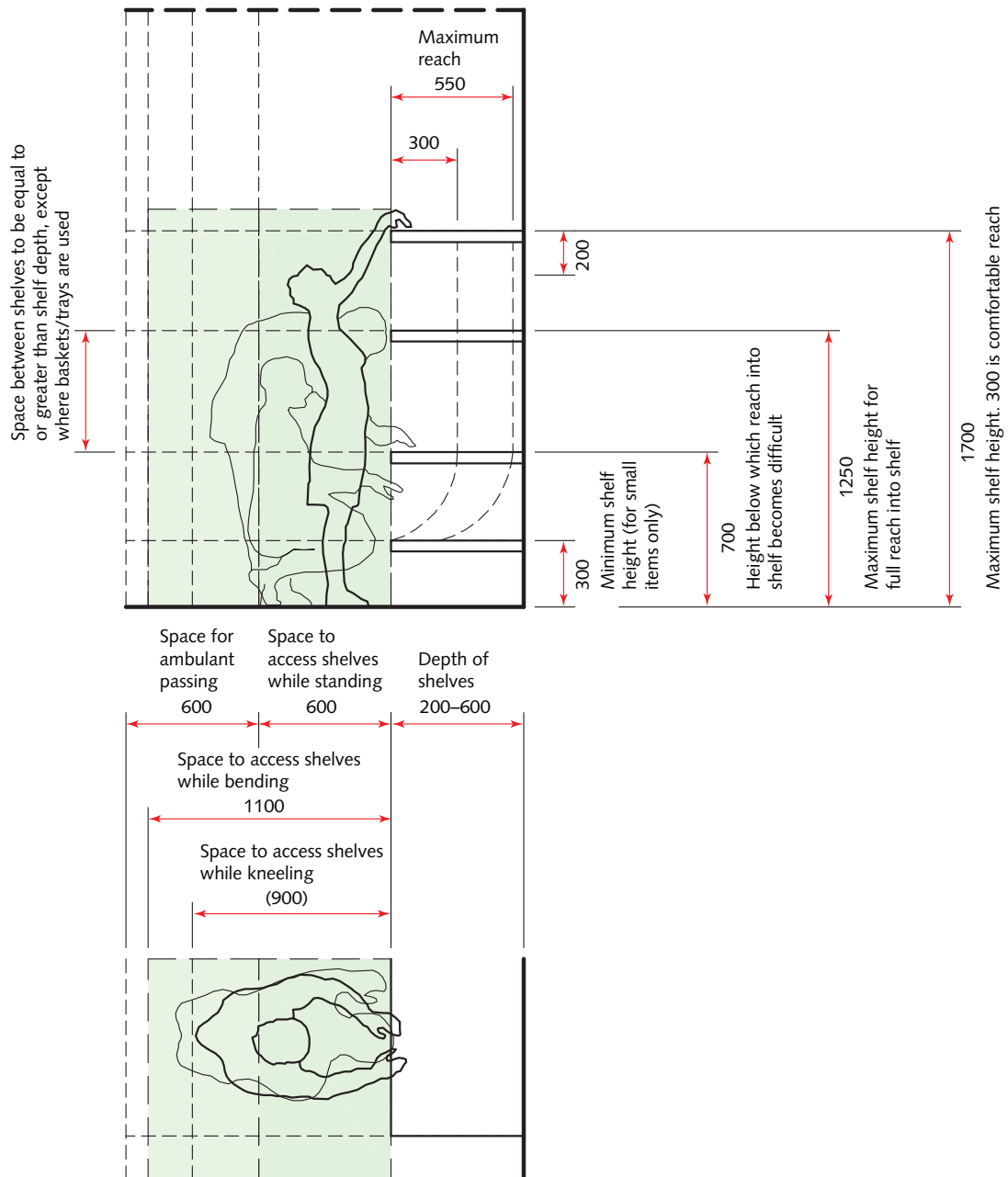



## Dirty utility room for bedpan processing

### Room description and layout

- 8.56 This room will fulfil the same functions as the dirty utility room with the addition of the disposal of the contents of bedpans and urine bottles into a macerator or bedpan washer.
- 8.57 It will also be used for storing clean urine bottles, bedpans (or bedpan liners) and vomit bowls, and for holding dirty linen where used. Commodes and sani-chairs may be stored here.
- 8.58 The location of the dirty utility rooms should minimise travel distances for staff from patient areas to reduce the risk of spillages and cross contamination, and to increase working efficiencies.
- 8.59 Local policy will determine whether to use disposable or reusable urine bottles and vomit bowls and/or whether to use bedpans with liners.
- 8.60 The room layout provided (see [Figure 74](#)) is based on the use of a macerator or washer.
- 8.61 Where a macerator is used, consideration should be given to providing both a macerator for the disposal of the liners and waste products and a washer for the subsequent cleaning of bedpan holders etc. This arrangement is currently a topic for discussion on the basis of perceived improved infection control but is not specifically recommended.
- 8.62 The illustrated space requirements for accessing modular base and upper cabinets is based on space to access standard cupboards, not using baskets or trays. However, adequate space is available for side access to baskets or trays.
- 8.63 The layout has taken on board research from the Loughborough University Healthcare Ergonomics & Patient Safety unit, DH research report B(05)02, Dec 2007.

Figure 74 Space requirements for dirty utility room for bedpan processing

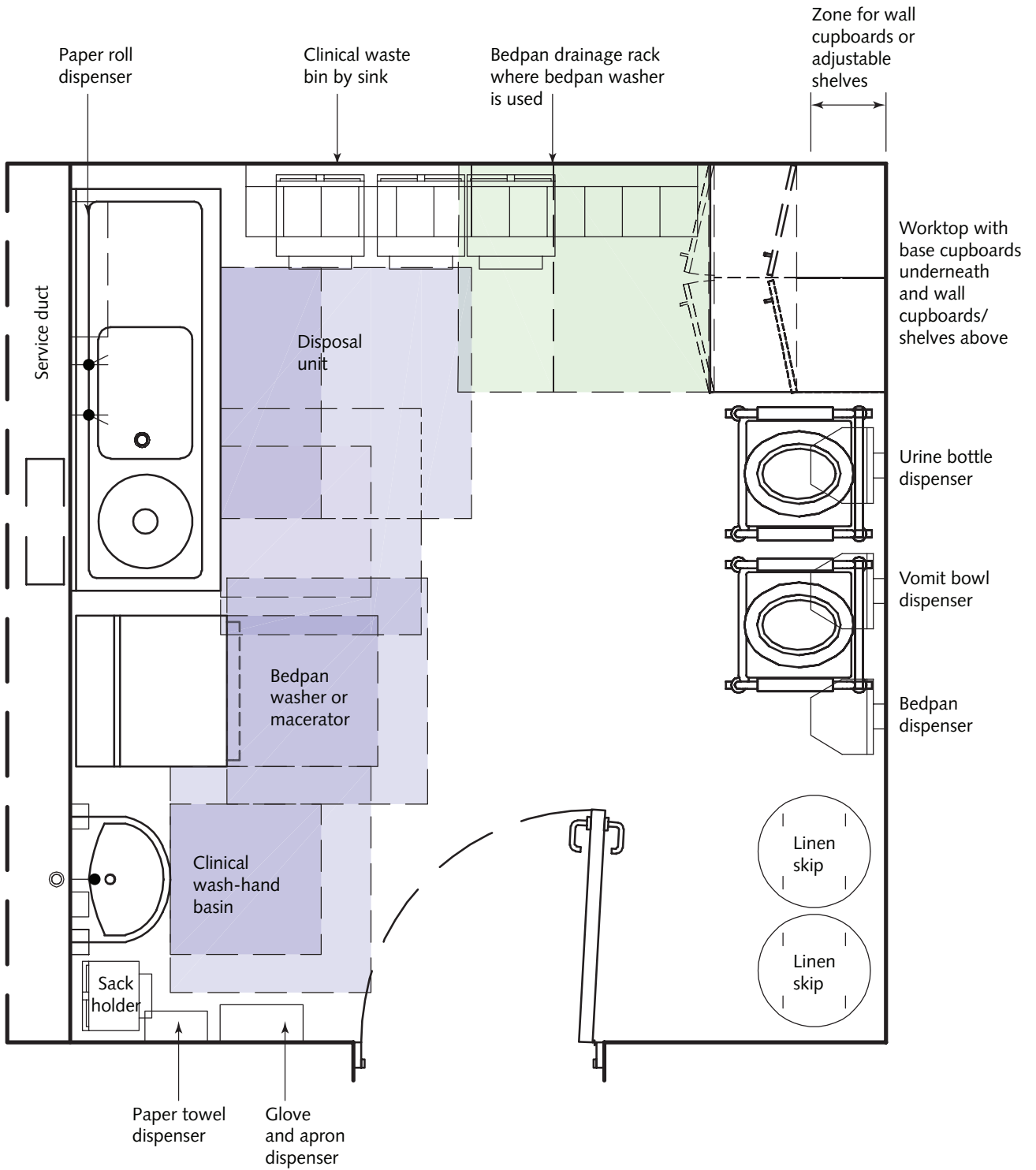

**Ergonomic drawings**

*Clinical wash-hand basin*

8.64 These ergonomic drawings (see Figure 75) show the space requirements for standing use of a clinical wash-hand basin assembly. For seated use, the basin will need to be lowered.

8.65 The basin should be fitted with non-touch taps.

8.66 The recommended fixing height of a lever tap on a clinical wash-hand basin is 1095 mm. Where a lever tap is used, the fixing height of the dispensers should be chosen to reduce any possible conflicts in use.

8.67 The illustrated clinical wash-hand basin projects 400 mm from the back panel or wall. However, clinical wash-hand basins may vary from 350 to 500 mm projection. Where basins deeper than 400 mm are used, the impact on/from other components and/or activities undertaken within any space should be considered when evaluating any room layout.

8.68 The glove and apron dispenser illustrated is a combined unit; this is considered the most compact solution although separate units may also be used. Even the most compact unit cannot practically be located within comfortable reach of the basin; it should, however, be conveniently located within the room.

8.69 The ergonomic advice for the height of horizontal elbow operated lever taps is based on the following data:

“Elbow height for shod, slightly bent posture (as when leaning forward) for 50%ile UK male = 1134 mm, for female 1049 mm. 1090 mm is considered the best compromise for an elbow height for both male and female use. The ergonomic advice for the height of a lever tap is 75 mm below elbow height giving a figure height of approx 1015 mm.”

8.70 Lever taps are not illustrated.

8.71 For detailed information on basins, see Health Building Note 00-10 Part C – ‘Sanitary assemblies’.

Figure 75 Space requirements for standing use of a clinical wash-hand basin assembly

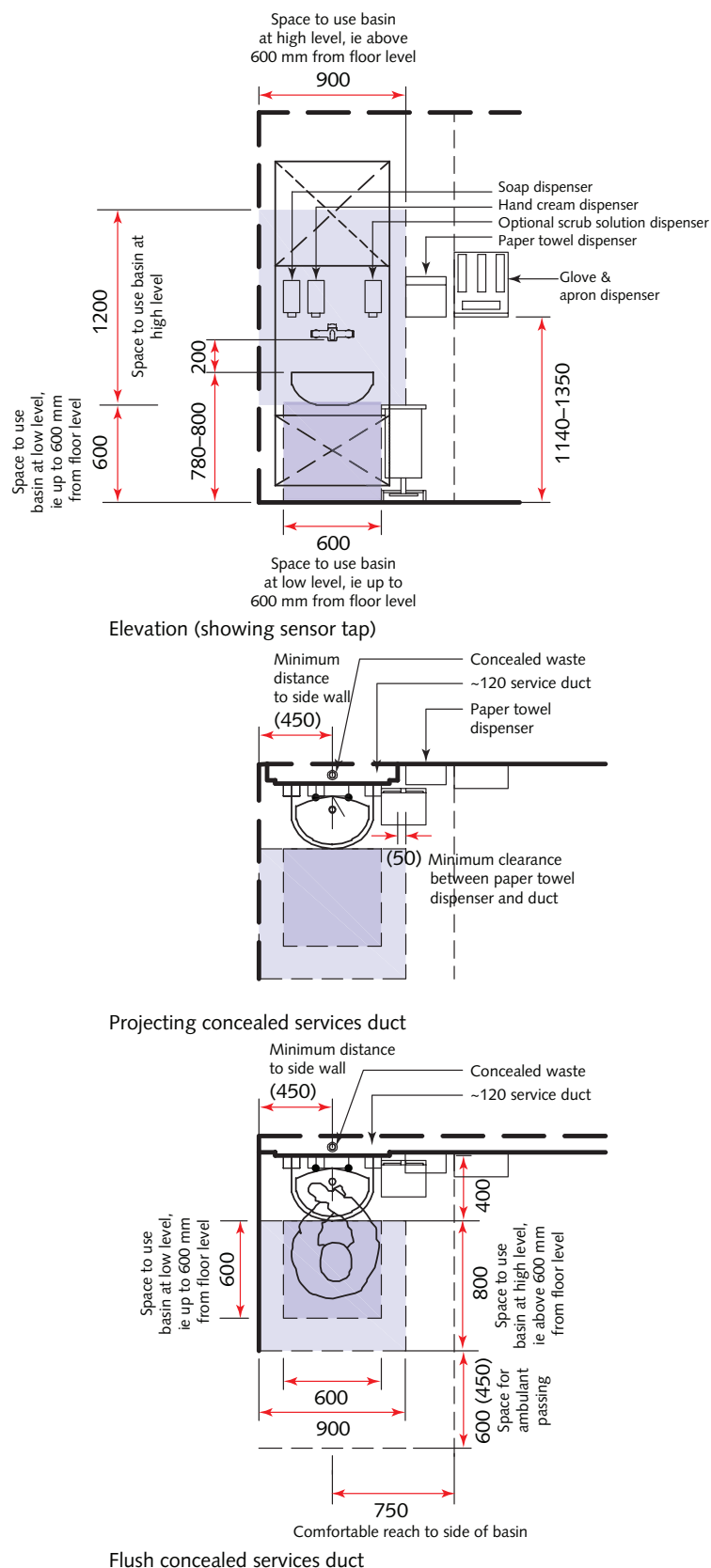

Disposal unit

8.72 This ergonomic drawing (see Figure 76) shows the space requirements for a disposal unit comprising a combined sink and hopper.

8.73 Subject to local infection control advice, consideration may be given to providing integrated units (that is, a combined unit with a washer or macerator, bucket sink, and base cupboard/storage unit).

Figure 76 Space requirements for disposal unit comprising combined sink and hopper

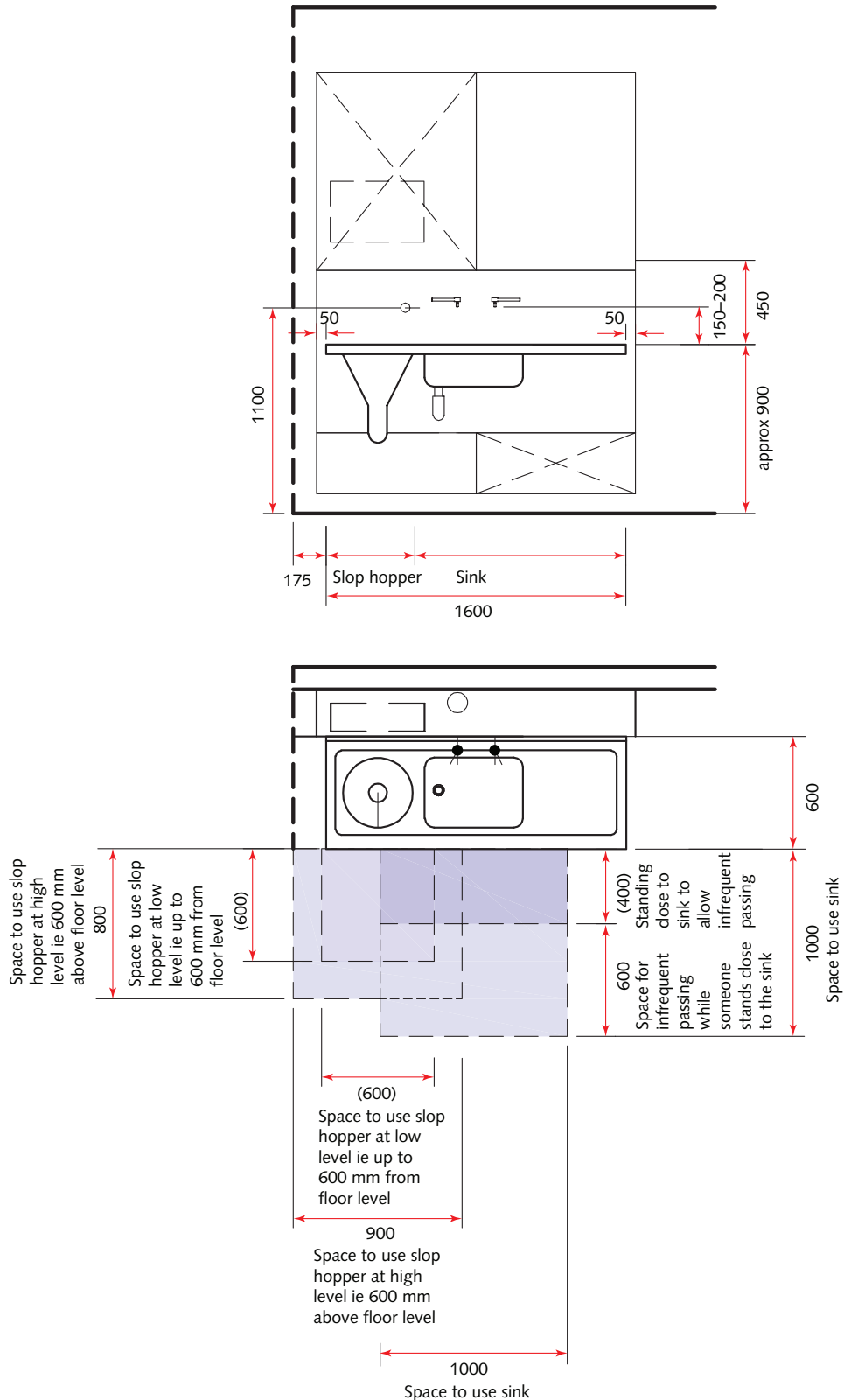

### *Washers and macerators*

- 8.74 Washers are available in tall and low profile models. Tall models are front loading, with the loading door generally at working height. Low profile units may be top or front loading.
- 8.75 Most washers can process three bedpans and three urine bottles per cycle, with each cycle taking just under 10 minutes.
- 8.76 Consideration should be given to the safe storage of the detergents used in the cleaning process.
- 8.77 Macerators are generally low profile and top loading.
- 8.78 When macerators are used, local infection control advice should be sought on the appropriate cleaning regime for the bedpan itself since the macerator will only deal with the bedpan liners.
- 8.79 Electricity supply requirements for the washer or macerator are subject to manufacturers' information.
- 8.80 Drainage requirements vary. They may be located in rear, side or bottom of the unit but are generally 110 mm for washers and 50 mm for macerators. The indicative room layout assumes a 110 mm waste located in the rear.
- 8.81 It is important to consider the spatial requirements and services for the equipment as early as possible in the planning process. Failure to do so can result in a loss of functional space within the room (for example to allow for service ducts), which may be detrimental to safe and efficient working.
- 8.82 This ergonomic drawing (see [Figure 77](#)) illustrates the space requirements for a macerator or washer.

Figure 77 Space requirements for a macerator or washer



Front-loading tall washer

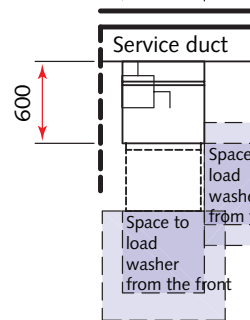
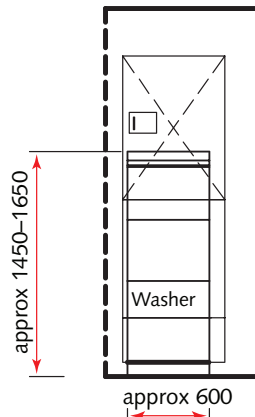

Space to use washer at low level ie up to 600 mm from floor level

Space to use washer at high level ie 600 mm above floor level



Top-loading washer/macerator

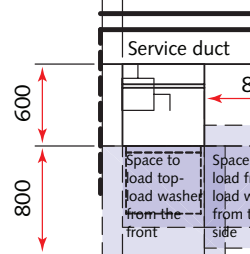
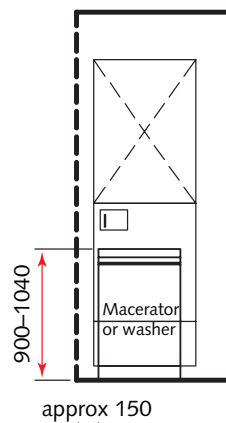

Space to use washer/macerator at low level ie up to 600 mm from floor level

Space to use washer/macerator at high level ie 600 mm above floor level



Front-loading washer

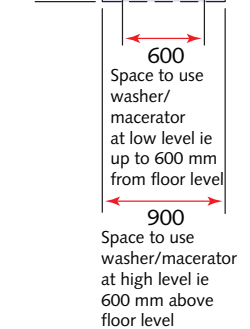

Space to use washer/macerator at low level ie up to 600 mm from floor level

Space to use washer/macerator at high level ie 600 mm above floor level

Standard base and wall cupboards

8.83 This ergonomic drawing (see Figure 78) shows the space requirements to access standard, floor mounted, base and wall cupboards. Where

worktops or other obstructions project more than 500 mm, the reach dimensions illustrated relate to the front edge of the wall cupboard (that is, reaching into the cupboard would be difficult).

Figure 78 Space requirements to access standard, floor mounted base and wall cupboards

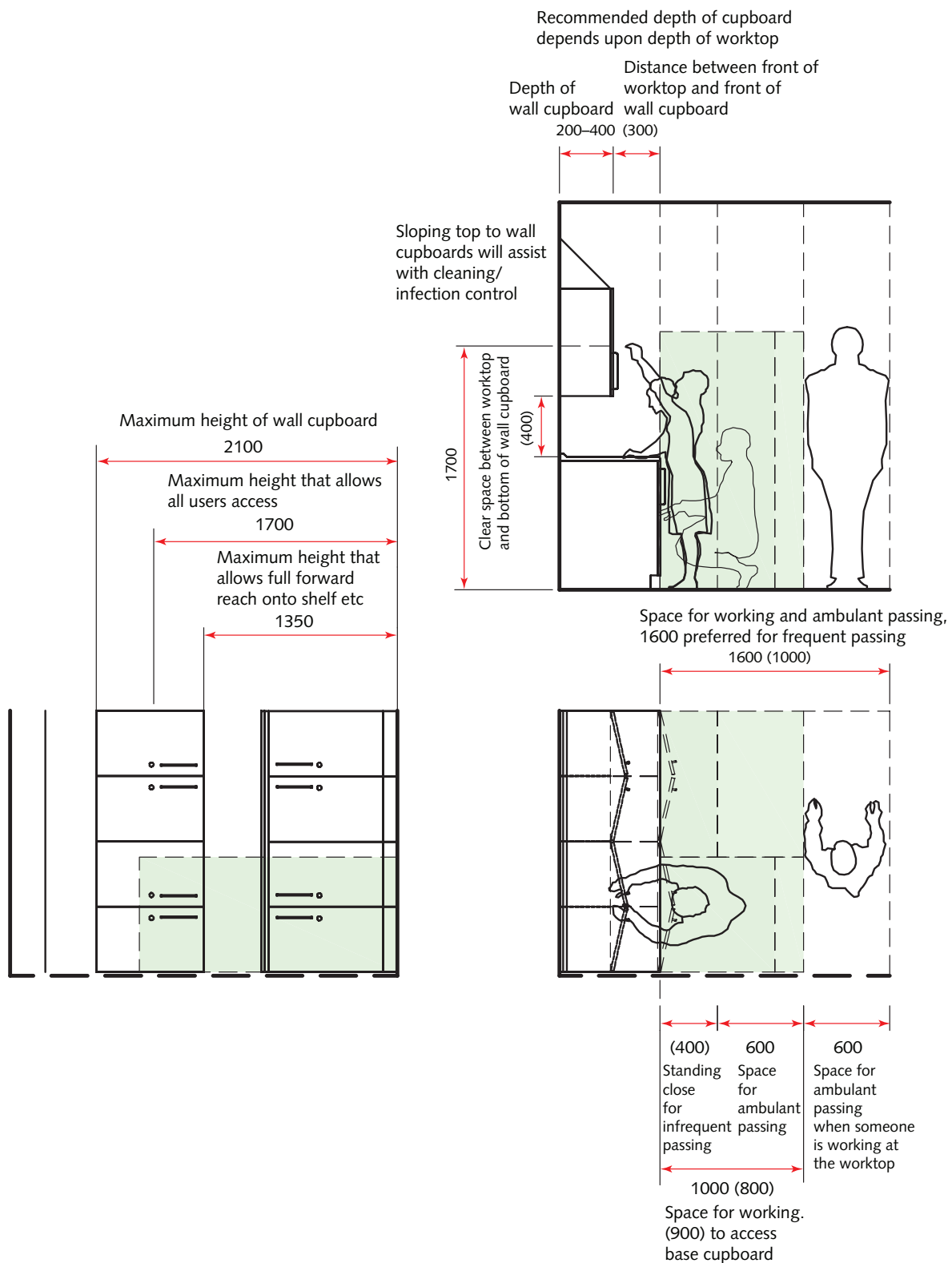

## Dirty utility room

### Room description and layout

- 8.84 This room is used for holding waste sacks prior to their removal to a disposal hold and for the disposal of small amounts of liquid human waste. Urinalysis may also take place here (using a dipstick). Small quantities of small items may be held here prior to reprocessing.
- 8.85 The space required for holding waste sacks will depend on the local disposal policy. As soon as sacks have been filled, to avoid cluttering and build-up of odours, they should be sealed and taken away (as soon as possible thereafter) to the associated disposal hold to await collection.
- 8.86 The location of dirty utility rooms should minimise travel distances for staff from patient areas to reduce the risk of spillages and cross contamination, and to increase working efficiencies.
- 8.87 The room layout provided (see [Figure 79](#)) is not appropriate where significant quantities of equipment need to be held for reprocessing (that is, where a CCSD returns trolley is required).
- 8.88 The illustrated space requirements for accessing modular base and upper cabinets is based on space to access standard cupboards, not using baskets or trays. However, adequate space is available for side access to baskets or trays.
- 8.89 The layout has taken on board research from the Loughborough University Healthcare Ergonomics & Patient Safety unit, DH research report B(05)02, Dec 2007.



Figure 79 Space requirements for dirty utility room

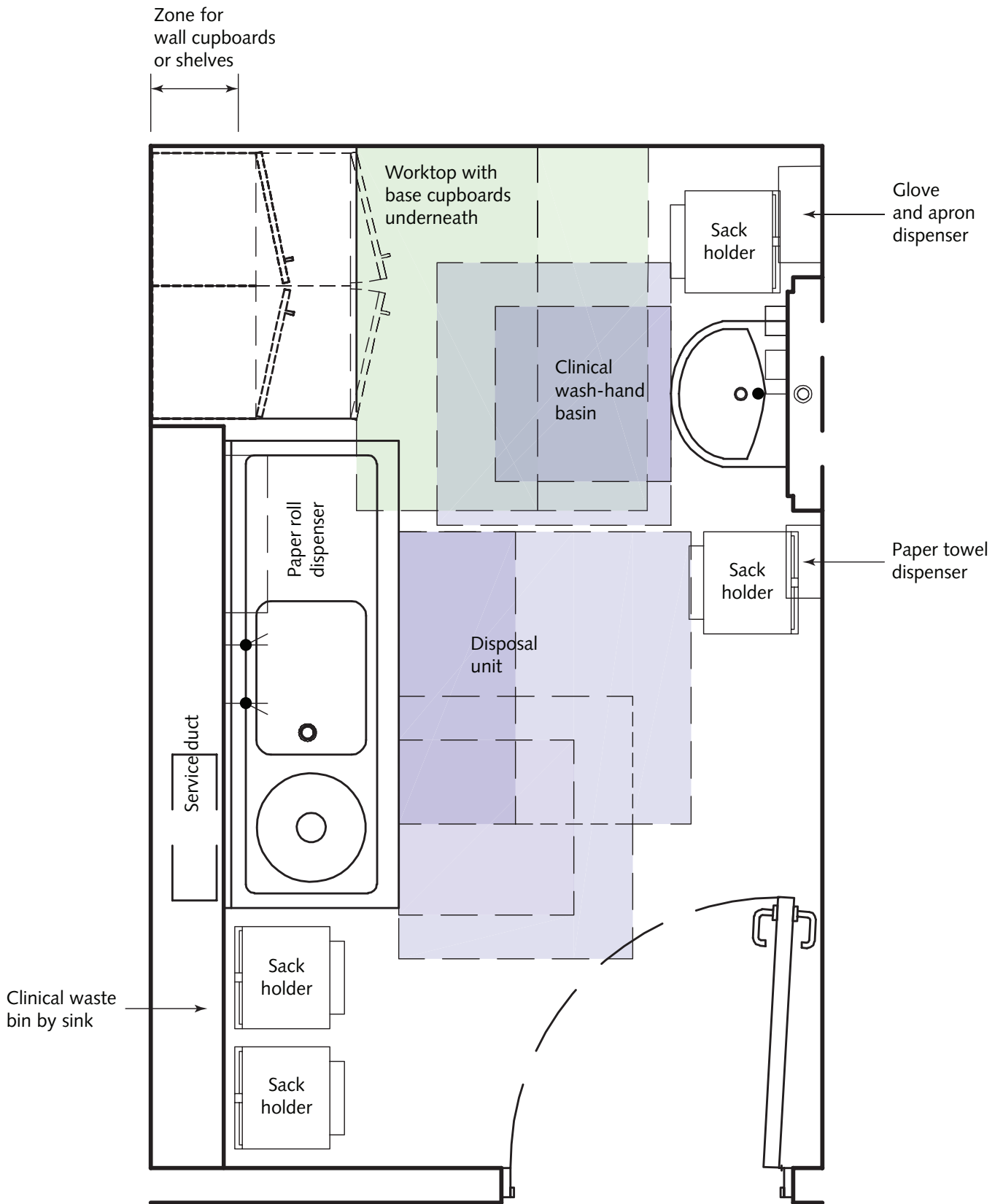

Ergonomic drawings

Clinical wash-hand basin

- 8.90 These ergonomic drawings (see Figure 80) show the space requirements for standing use of a clinical wash-hand basin assembly. For seated use, the basin will need to be lowered.
- 8.91 The basin should be fitted with non-touch taps.
- 8.92 The recommended fixing height of a lever tap on a clinical wash-hand basin is 1095 mm. Where a lever tap is used, the fixing height of the dispensers should be chosen to reduce any possible conflicts in use.
- 8.93 The illustrated clinical wash-hand basin projects 400 mm from the back panel or wall. However, clinical wash-hand basins may vary from 350 to 500 mm projection. Where basins deeper than 400 mm are used, the impact on/from other components and/or activities undertaken within any space should be considered when evaluating any room layout.
- 8.94 The glove and apron dispenser illustrated is a combined unit; this is considered the most compact solution although separate units may also be used. Even the most compact unit cannot practically be located within comfortable reach of the basin; it should, however, be conveniently located within the room.
- 8.95 The ergonomic advice for the height of horizontal elbow operated lever taps is based on the following data:  
 “Elbow height for shod, slightly bent posture (as when leaning forward) for 50%ile UK male = 1134 mm, for female 1049 mm. 1090 mm is considered the best compromise for an elbow height for both male and female use. The ergonomic advice for the height of a lever tap is 75 mm below elbow height giving a figure height of approx 1015 mm.”
- 8.96 Lever taps are not illustrated.
- 8.97 For detailed information on basins, see Health Building Note 00-10 Part C – ‘Sanitary assemblies’.

Figure 80 Space requirements for standing use of a clinical wash-hand basin assembly

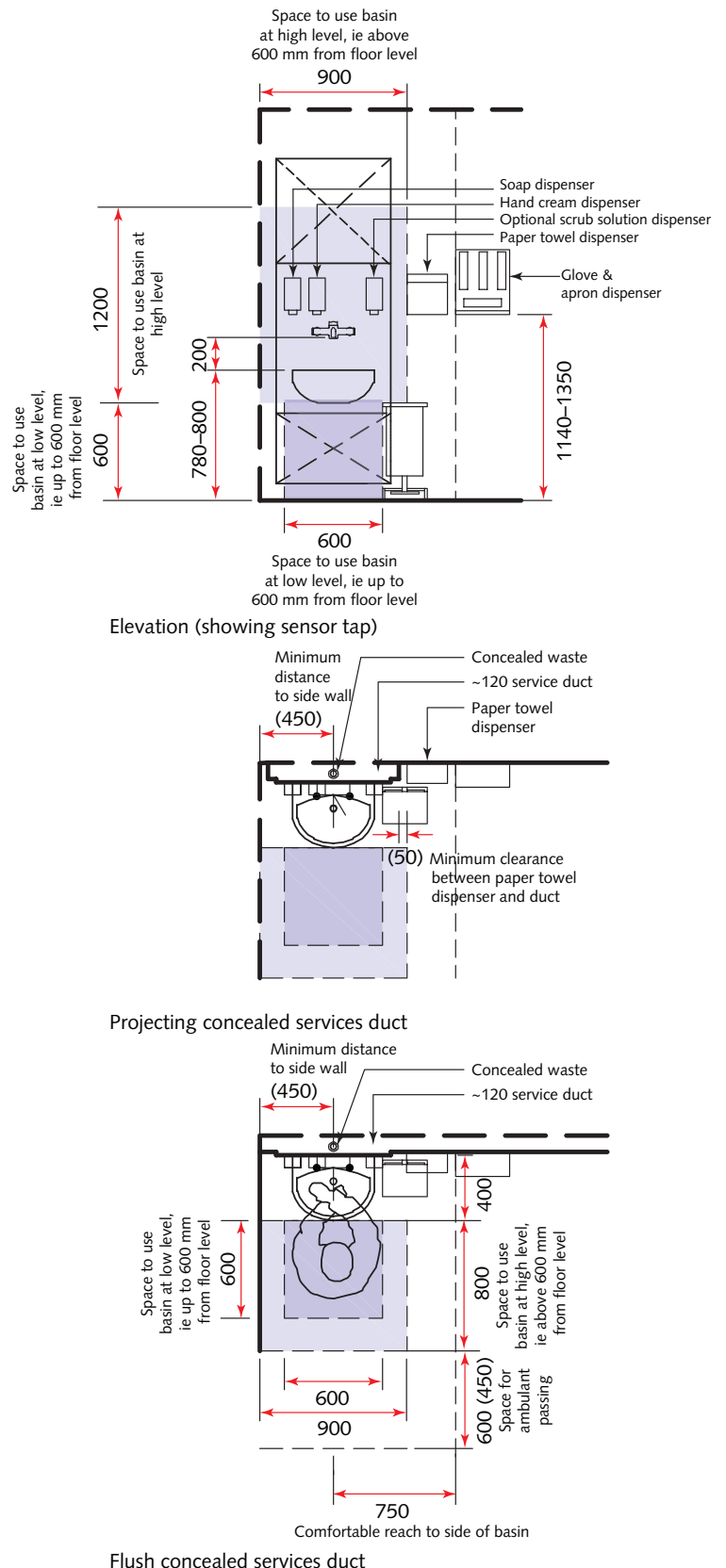

Disposal unit

8.98 This ergonomic drawing (see Figure 81) shows the space requirements for a disposal unit comprising a combined sink and hopper.

8.99 Subject to local infection control advice, consideration may be given to providing integrated units (that is, a combined unit with a washer or macerator, bucket sink, and base cupboard/storage unit).

Figure 81 Space requirements for a disposal unit comprising a combined sink and hopper

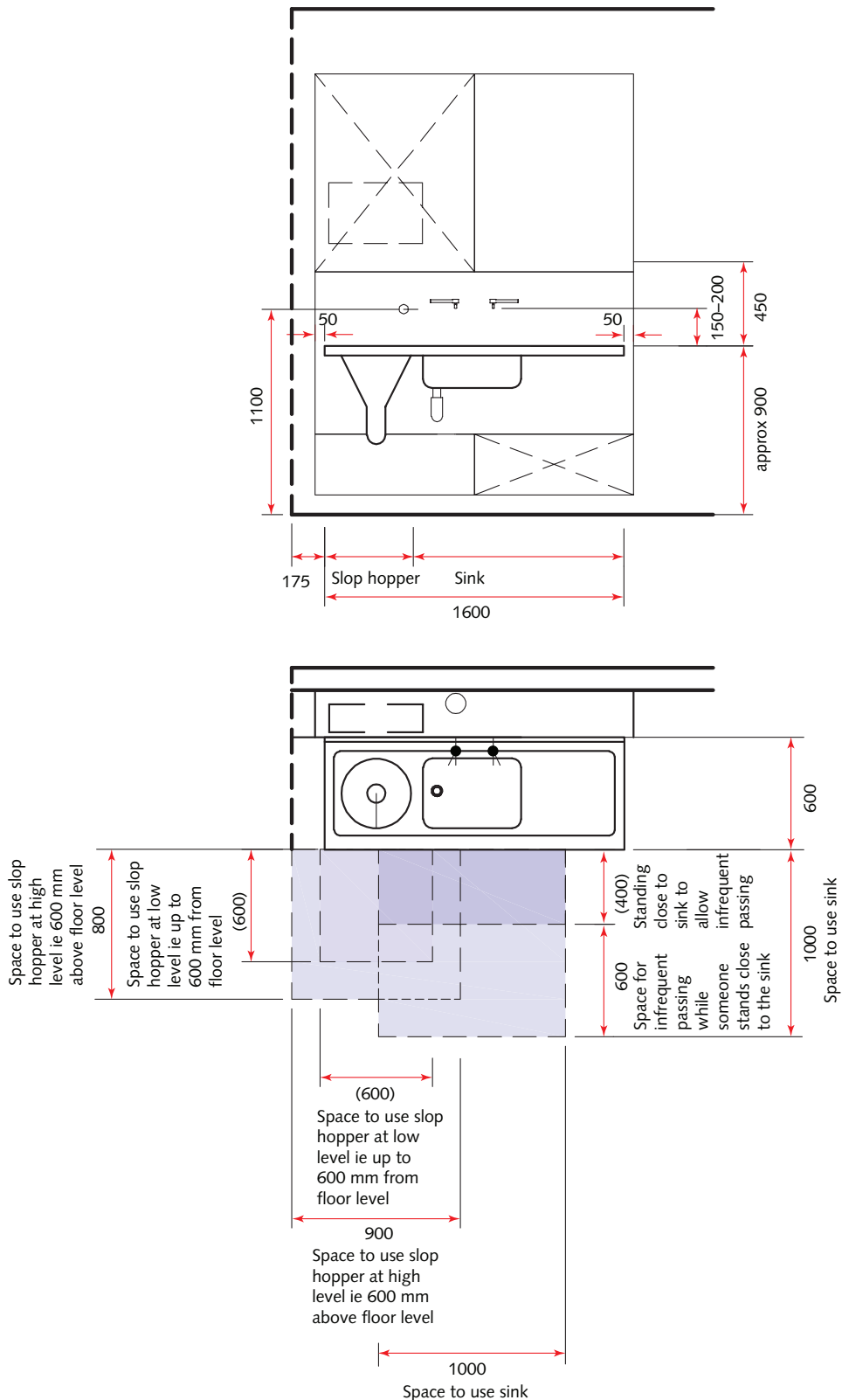

Standard base and wall cupboards

8.100 This ergonomic drawing (see Figure 82) shows the space requirements to access standard, floor mounted, base and wall cupboards. Where

worktops or other obstructions project more than 500 mm, the reach dimensions illustrated relate to the front edge of the wall cupboard (that is, reaching into the cupboard would be difficult).

Figure 82 Space requirements to access standard, floor mounted base and wall cupboards

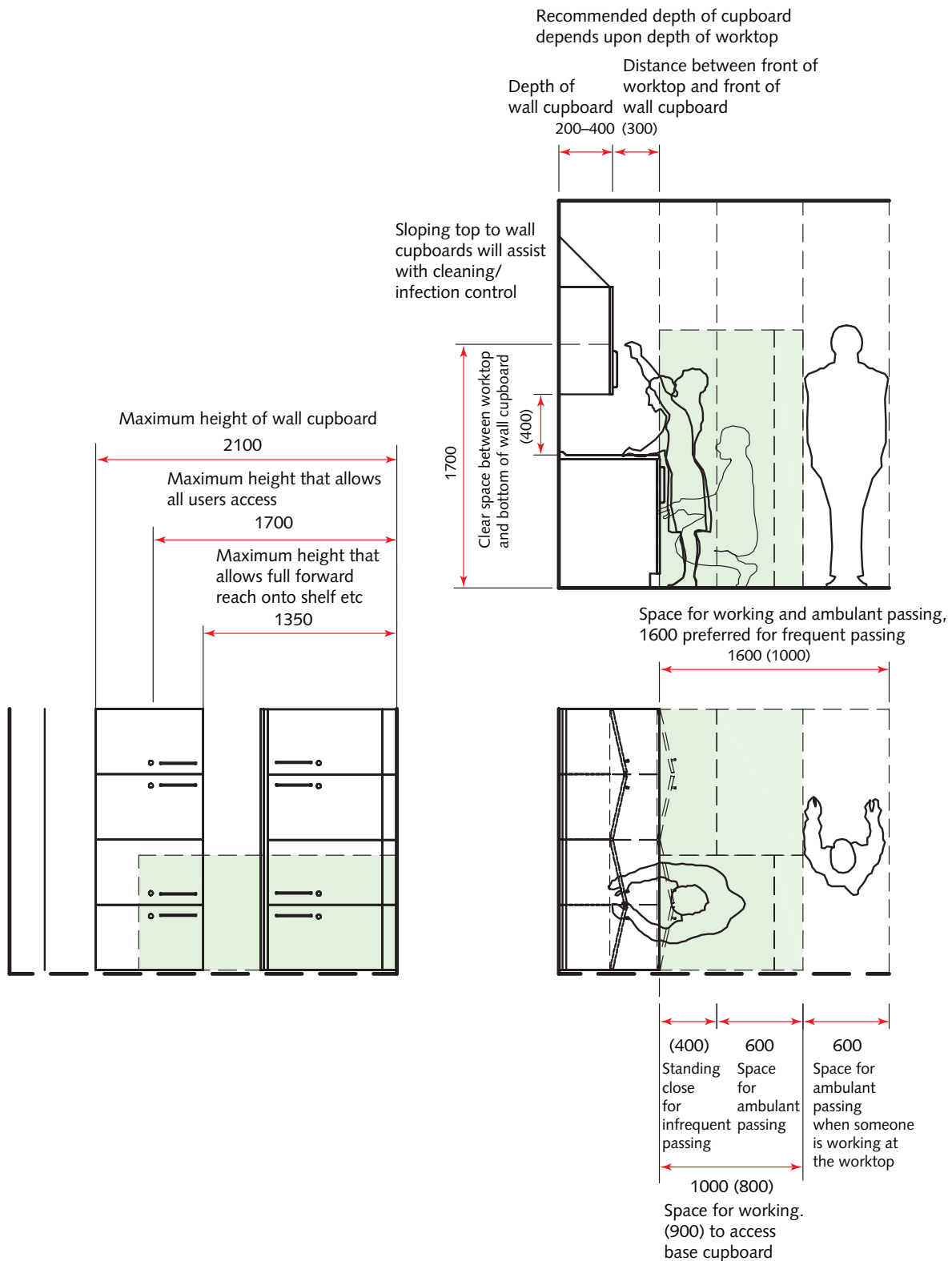

## Medicine store/preparation room

### Room description and layout

8.101 This room is used for storing and preparing medicines, including controlled drugs. This space will only be needed if a central clean supply room is used instead of clean utility rooms and

medicines storage/preparation is required outside clinical rooms. The illustrated space requirements (see Figure 83) for accessing modular base and upper cabinets is based on space to access standard cupboards, not using baskets or trays. However, adequate space is available for side access to baskets or trays.

Figure 83 Space requirements for medicine store/preparation room

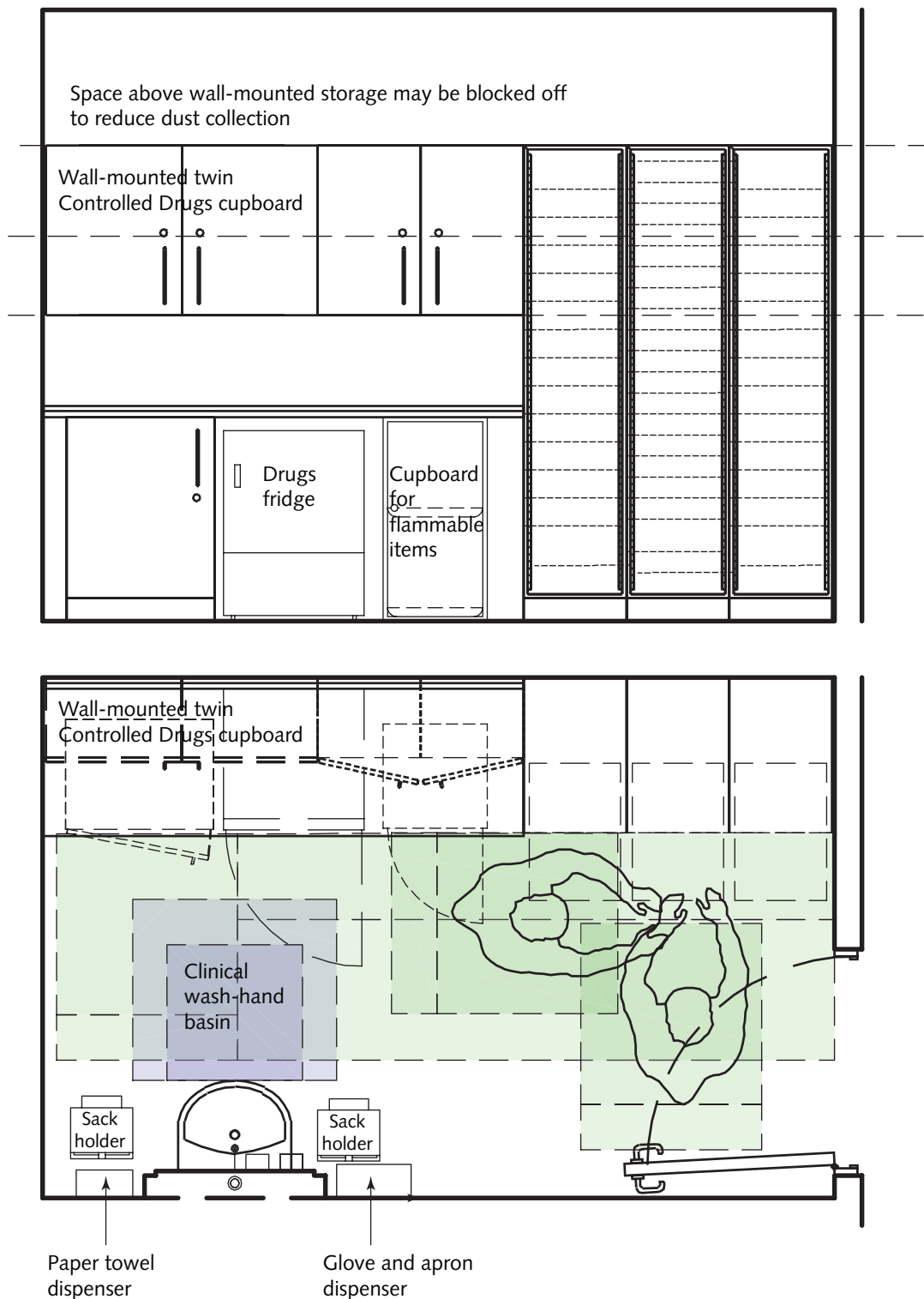

**Ergonomic drawings**

*Clinical wash-hand basin*

8.102 These ergonomic drawings (see Figure 84) show the space requirements for standing use of a clinical wash-hand basin assembly. For seated use, the basin will need to be lowered.

8.103 The basin should be fitted with non-touch taps.

8.104 The recommended fixing height of a lever tap on a clinical wash-hand basin is 1095 mm. Where a lever tap is used, the fixing height of the dispensers should be chosen to reduce any possible conflicts in use.

8.105 The illustrated clinical wash-hand basin projects 400 mm from the back panel or wall. However, clinical wash-hand basins may vary from 350 to 500 mm projection. Where basins deeper than 400 mm are used, the impact on/from other components and/or activities undertaken within any space should be considered when evaluating any room layout.

8.106 The glove and apron dispenser illustrated is a combined unit; this is considered the most compact solution although separate units may also be used. Even the most compact unit cannot practically be located within comfortable reach of the basin; it should, however, be conveniently located within the room.

8.107 The ergonomic advice for the height of horizontal elbow operated lever taps is based on the following data:

“Elbow height for shod, slightly bent posture (as when leaning forward) for 50%ile UK male = 1134 mm, for female 1049 mm. 1090 mm is considered the best compromise for an elbow height for both male and female use. The ergonomic advice for the height of a lever tap is 75 mm below elbow height giving a figure height of approx 1015 mm.”

8.108 Lever taps are not illustrated.

8.109 For detailed information on basins, see Health Building Note 00-10 Part C – ‘Sanitary assemblies’.

Figure 84 Space requirements for standing use of a clinical wash-hand basin assembly

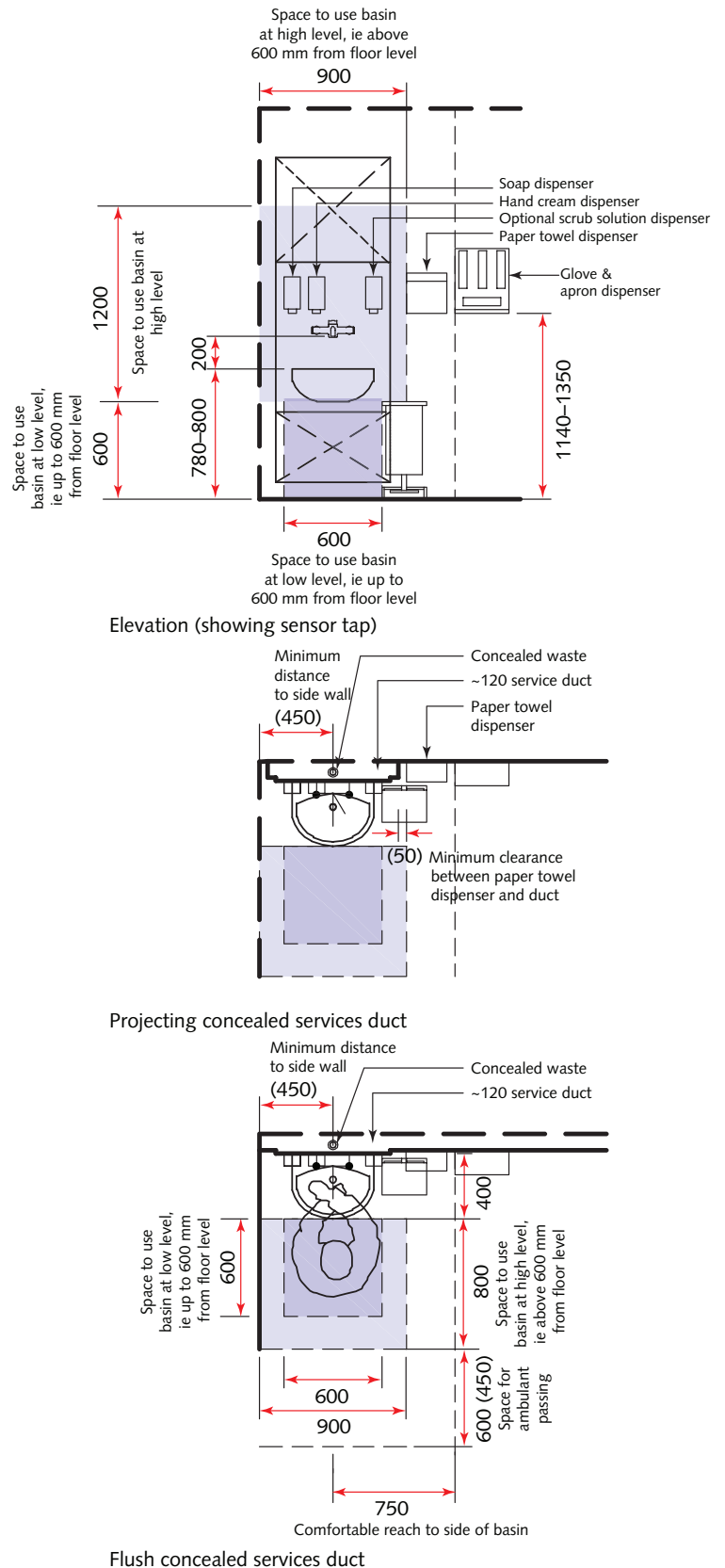

*Tall modular storage cabinets*

8.110 Tall modular storage cabinets are generally constructed to accommodate 600 × 400 mm baskets and trays to provide a variety of fixed or mobile storage options. The cabinets may be constructed to have either 400 mm or 600 mm wide facing baskets or trays.

8.111 This ergonomic drawing (see Figure 85) shows the space requirements to access a cabinet with 600 mm wide baskets/trays.

8.112 Tall modular storage cabinets are generally 2100 mm high; the top shelves are higher than those recommended for normal fixed storage units because the baskets/trays can be angled to enable their contents to be accessed.

Figure 85 Space requirements to access tall modular storage cabinets with 600 mm wide baskets/trays

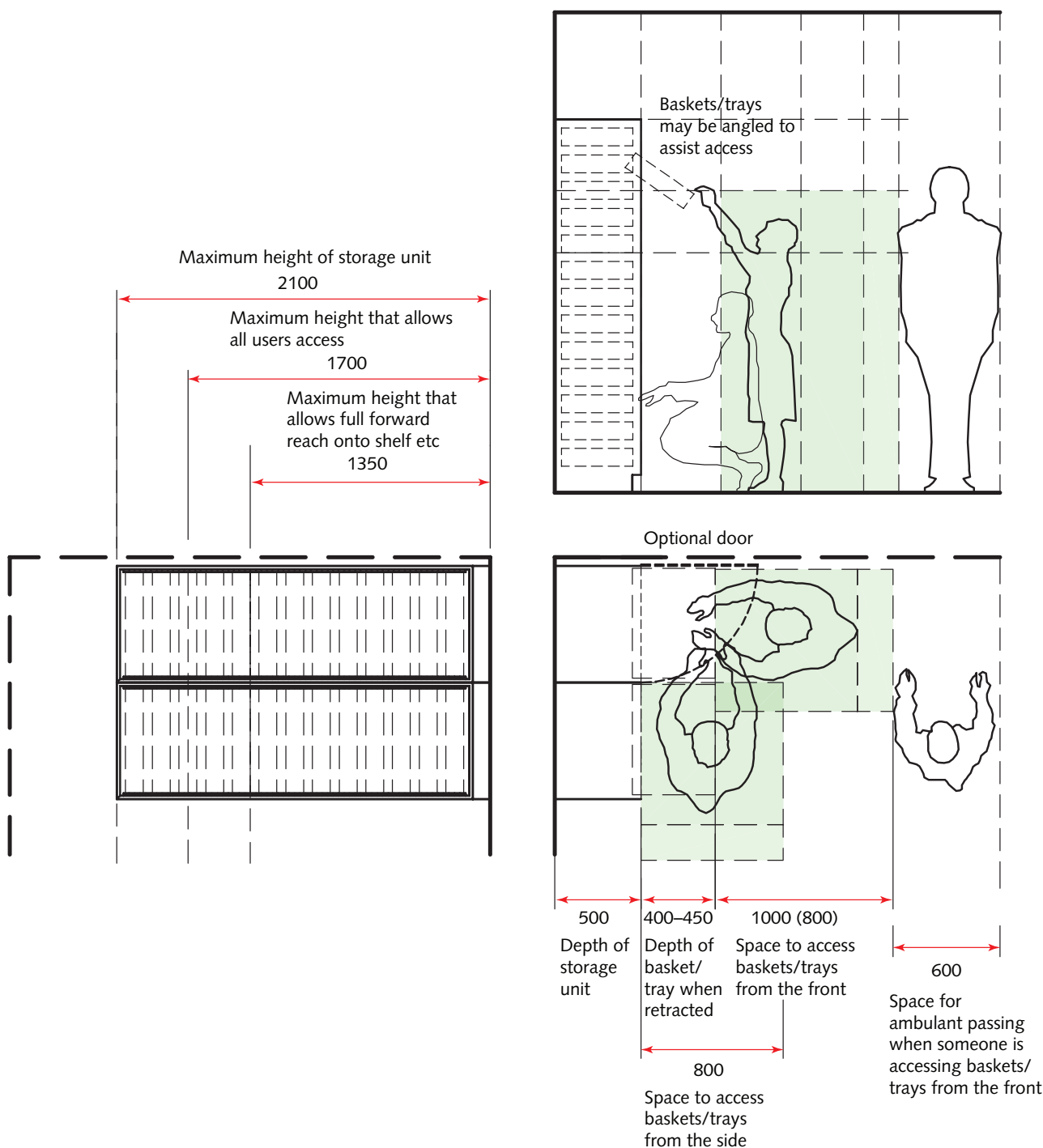

# 9 Generic clinical support spaces: Facilities management

## Cleaners' room

### Room description and layout

- 9.1 This room is used to deliver day-to-day cleaning services for a defined area. Cleaning materials and equipment in daily use should be stored in this room.
- 9.2 The number of cleaners' rooms required within a healthcare building will depend on:
  - the operational policy of domestic services;
  - the need to locate cleaning spaces close to areas served balanced against the need to avoid duplication of space and equipment.
- 9.3 The scope for sharing cleaners' rooms between departments/functional units should be explored. Project teams should discuss this matter with domestic services staff and infection control advisors. Sharing may alter basic equipment needs.
- 9.4 The equipment and materials to be stored will depend upon the finishes within the accommodation and the domestic services policies. This in turn will determine space requirements.
- 9.5 The room layout provided (see [Figure 86](#)) indicates a wet zone with a combined bucket sink and hand-rinse basin (janitorial unit) and a separate sink. The bucket sink is for emptying buckets and the separate sink is for filling buckets. There should be unrestricted access to the sink and janitorial unit.
- 9.6 Space has been provided for a vacuum cleaner and scrubbing/polishing machine (for hard floors). It is assumed that the mop and bucket are stored on the cleaners' trolley.
- 9.7 If large/bulky equipment is stored elsewhere (that is, in a central cleaners' room), the size of this room can be reduced. Exact space requirements for trolleys, cleaning materials and equipment should be determined locally.
- 9.8 Consideration must be given to the CoSHH requirements for the storage of cleaning materials. No specific provision has been included within the room layout.
- 9.9 A locker may be provided for storing personal belongings.



Figure 86 Space requirements for cleaners' room

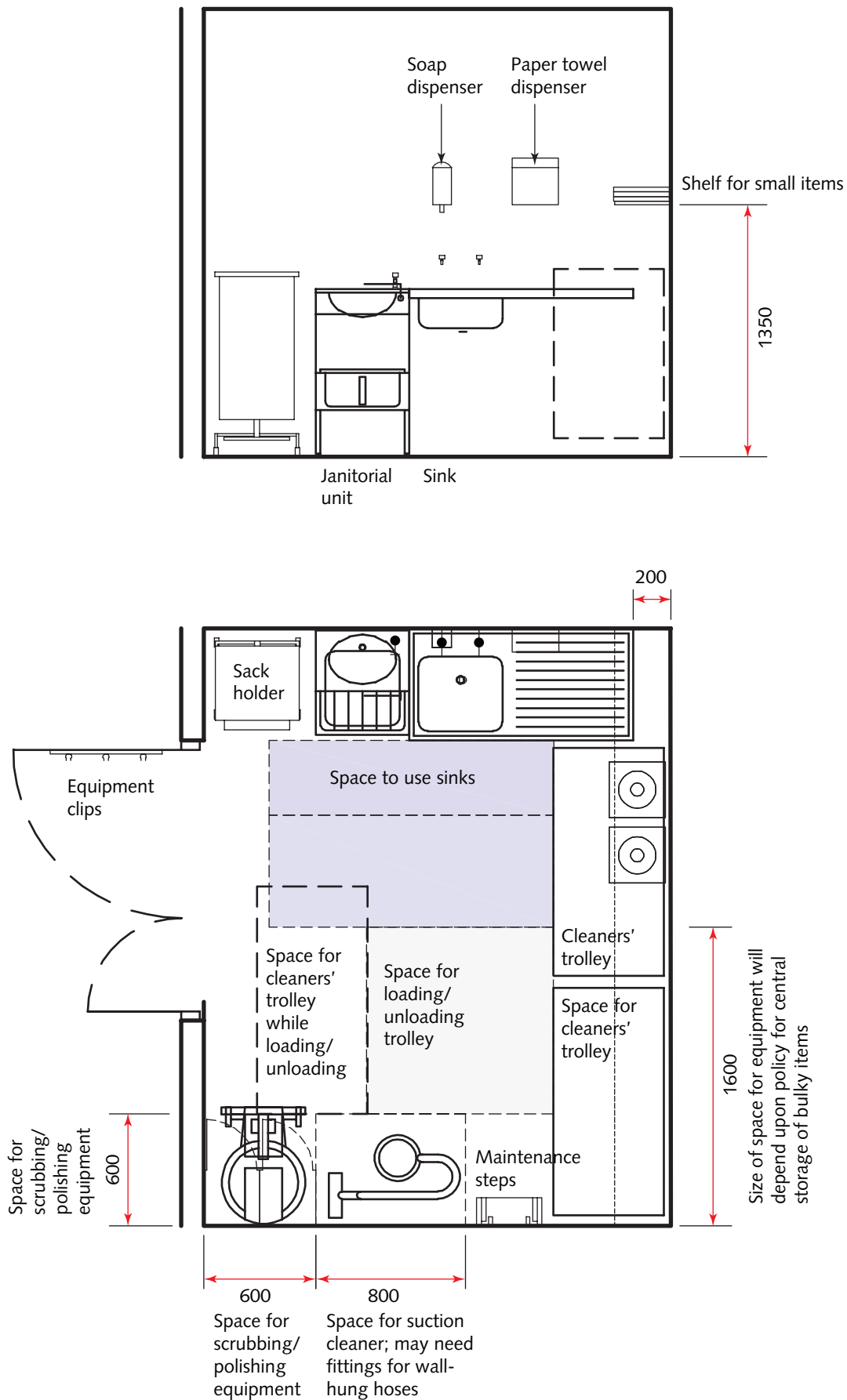

**Ergonomic drawings**

*Sink top*

- 9.10 This ergonomic drawing (see Figure 87) shows the space requirements for a sink. Generally all sinks should have a worktop or drainer on either side.
- 9.11 The recommended sink rim height is 950 mm for comfortable ergonomic access. Where it is

considered dangerous or unacceptable for the sink rim to be above the worktop, both should be at 900 mm, although this will result in taller users having to bend down to use the sink.

- 9.12 For detailed information on sinks, see Health Building Note 00-10 Part C – ‘Sanitary assemblies’.

Figure 87 Space requirements for a sink

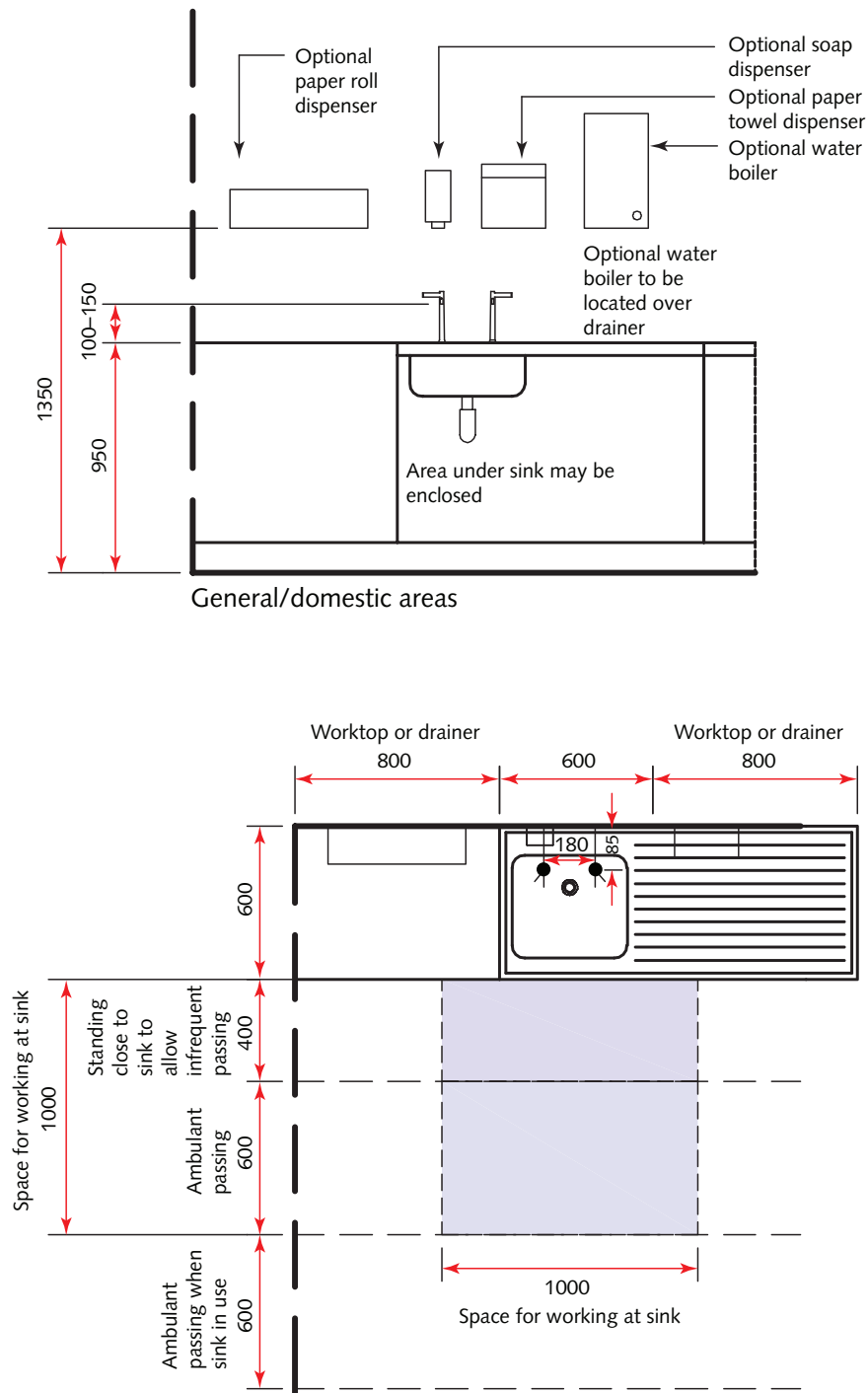

## Central cleaners' room

### Room description

9.13 Central cleaners' rooms provide space for storing bulky items of cleaning equipment. Requirements will depend upon:

- the type of equipment to be stored, which will be determined by the size and nature of the building and the way cleaning services are delivered;
- the degree to which cleaning equipment can be centralised.

### Disposal hold: 1700 litres

#### Room description and layout

9.14 The disposal hold provides space for the safe holding of waste and/or equipment prior to its disposal and/or reprocessing. Separate bins should

be provided for clinical and domestic waste. Space should be provided for recyclable waste. Cytotoxic waste should be held in special containers.

9.15 The disposal hold should be lockable and secure. It should be located adjacent to a main circulation route and may be accessible from outside the area it serves to allow removal of waste by FM staff without entering the clinical zone.

9.16 It should contain different zones/containers for different types of waste, for example general, incineration (clinical), hazardous.

9.17 The size of a disposal hold will depend on the size and type of bins used and the frequency of collections. See Figures 88 and 89. Typical bin sizes are as follows:

- 120 litre = 900 mm × 480 mm × 550 mm;
- 240 litre = 1060 mm × 585 mm × 730 mm;
- 360 litre = 1110 mm × 590 mm × 895 mm;

Figure 88 Space requirements for a disposal hold, central cleaners' room

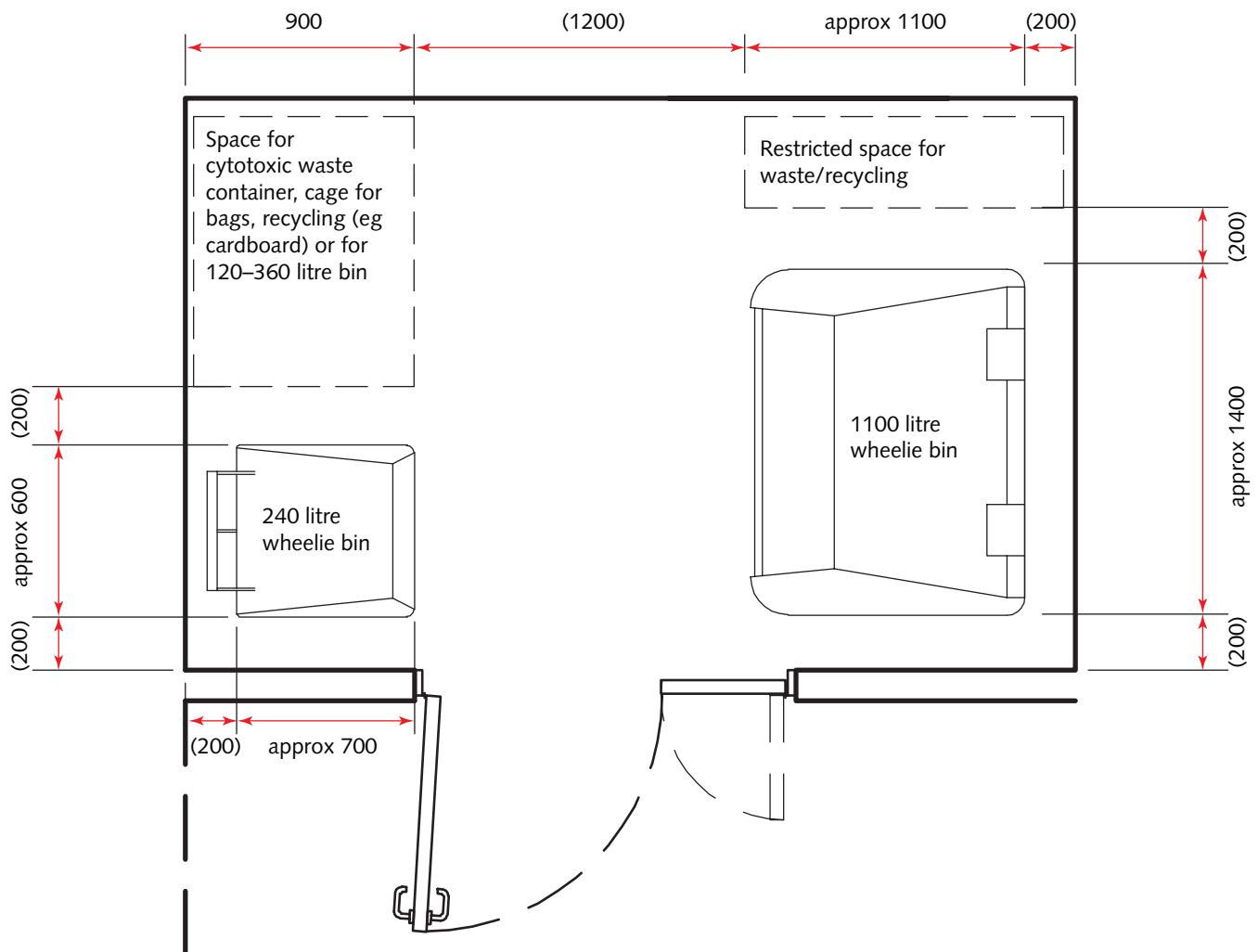

- 770 litre = 1360 mm × 1360 mm × 798 mm;
- 1100 litre = 1470 mm × 1370 mm × 1115 mm.

Figure 89 Space requirements for a disposal hold, central cleaners' room

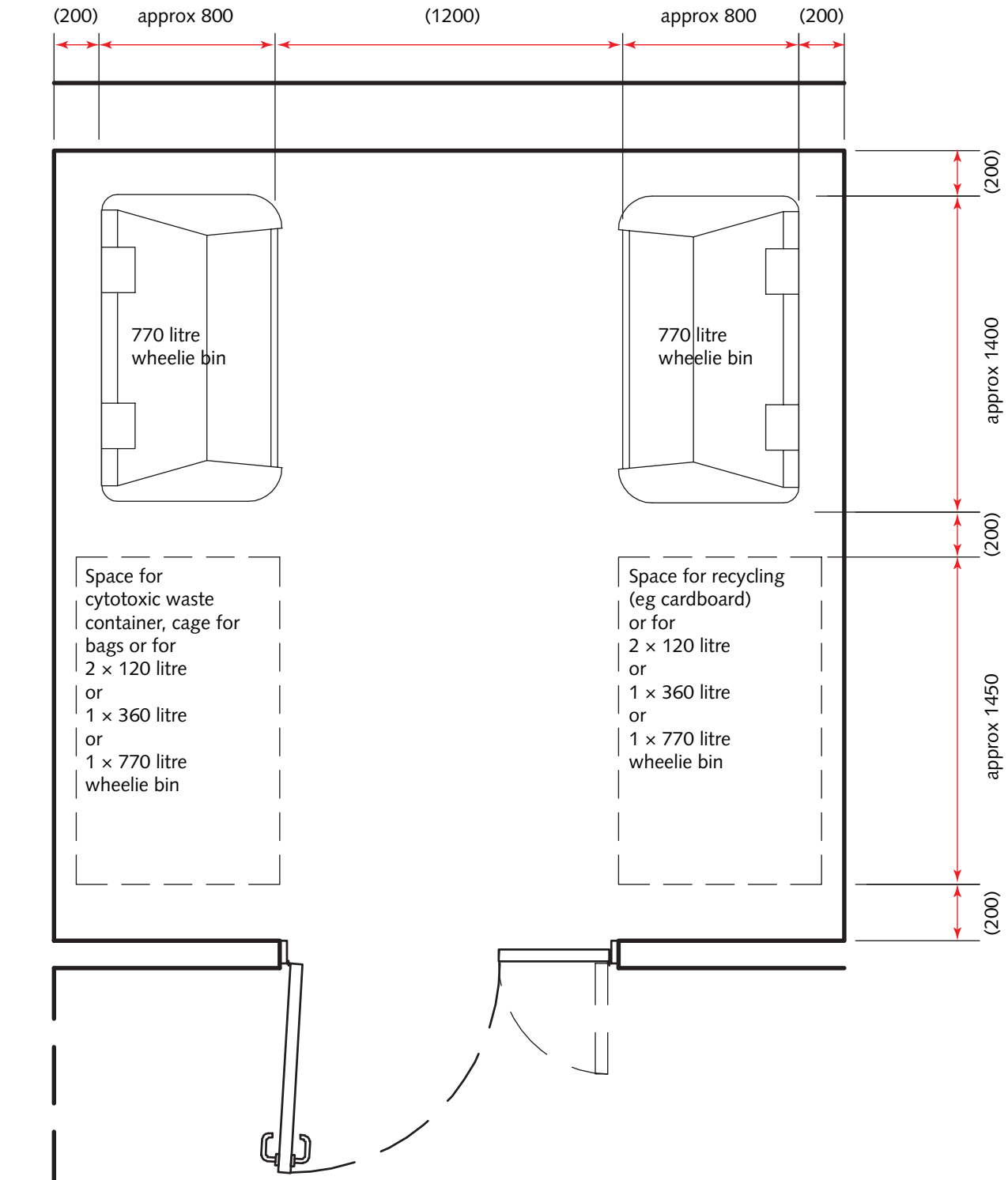

## 10 Generic clinical support spaces: Refreshments and rest

### Mini kitchen

#### Room description and layout

- 10.1 A mini kitchen is an open area for preparing snacks and beverages that may be added to another space within staff, patient or visitor areas. Limited amounts of dry goods and refrigerated items will be stored here.
- 10.2 It may be purchased as a complete unit or built from individual components. The unit may be enclosed by doors or roller shutters to enable it to be shut off when not in use.
- 10.3 A mini kitchen is slightly more space efficient than a pantry/refreshment area although it may have reduced flexibility in use, depending upon location (for example if located in a rest room or day space its use requires entering the room in which it is located).
- 10.4 Facilities should meet all health and safety regulations.
- 10.5 Hand rinsing facilities must be provided wherever food is being prepared.
- 10.6 Local policy will determine whether to include a microwave.
- 10.7 The layout shown (see [Figure 90](#)) is only suitable for ambulant and semi-ambulant access. Where wheelchair access is required, the room needs to be bigger, worktops will need to be lowered and the cupboards under the sink removed. See Approved Document M and BS 8300 for further guidance.
- 10.8 A hot water dispenser will be required. Chilled water may also be provided.
- 10.9 Consideration should be given to the finishes within the mini kitchen area in relation to the finishes elsewhere in the space to which it is added to allow for water spillage etc.

Figure 90 Space requirements for ambulant and semi-ambulant access to a mini-kitchen

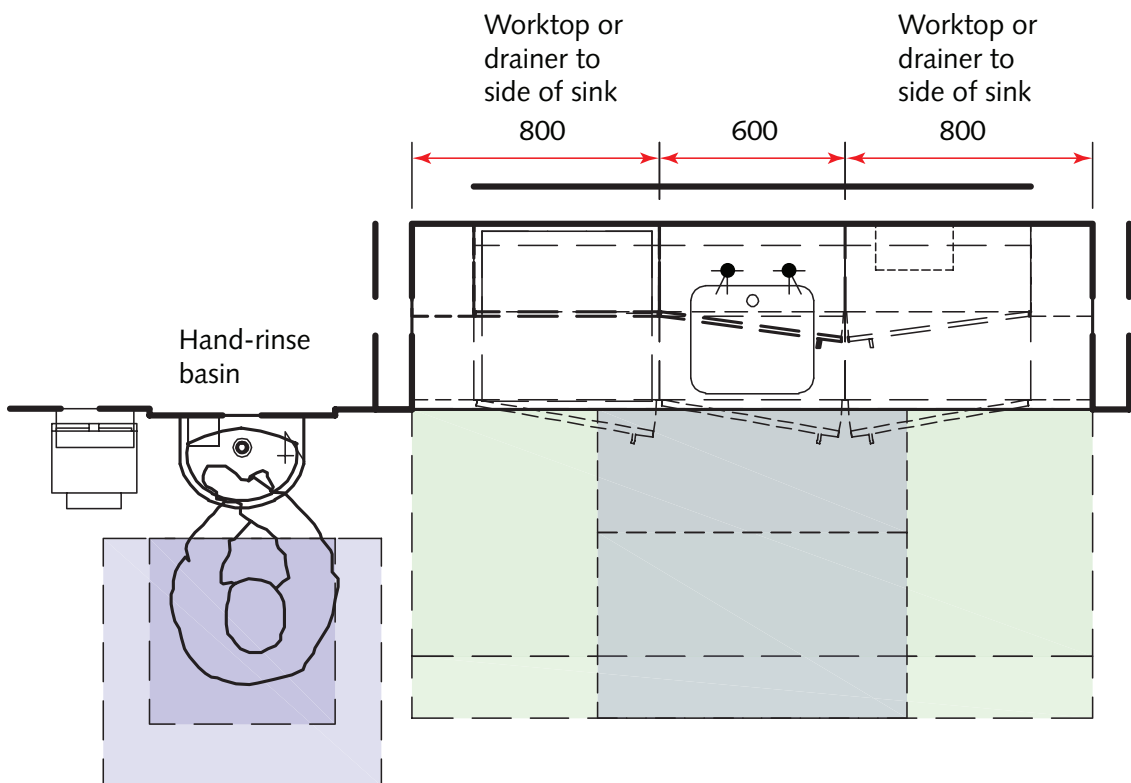
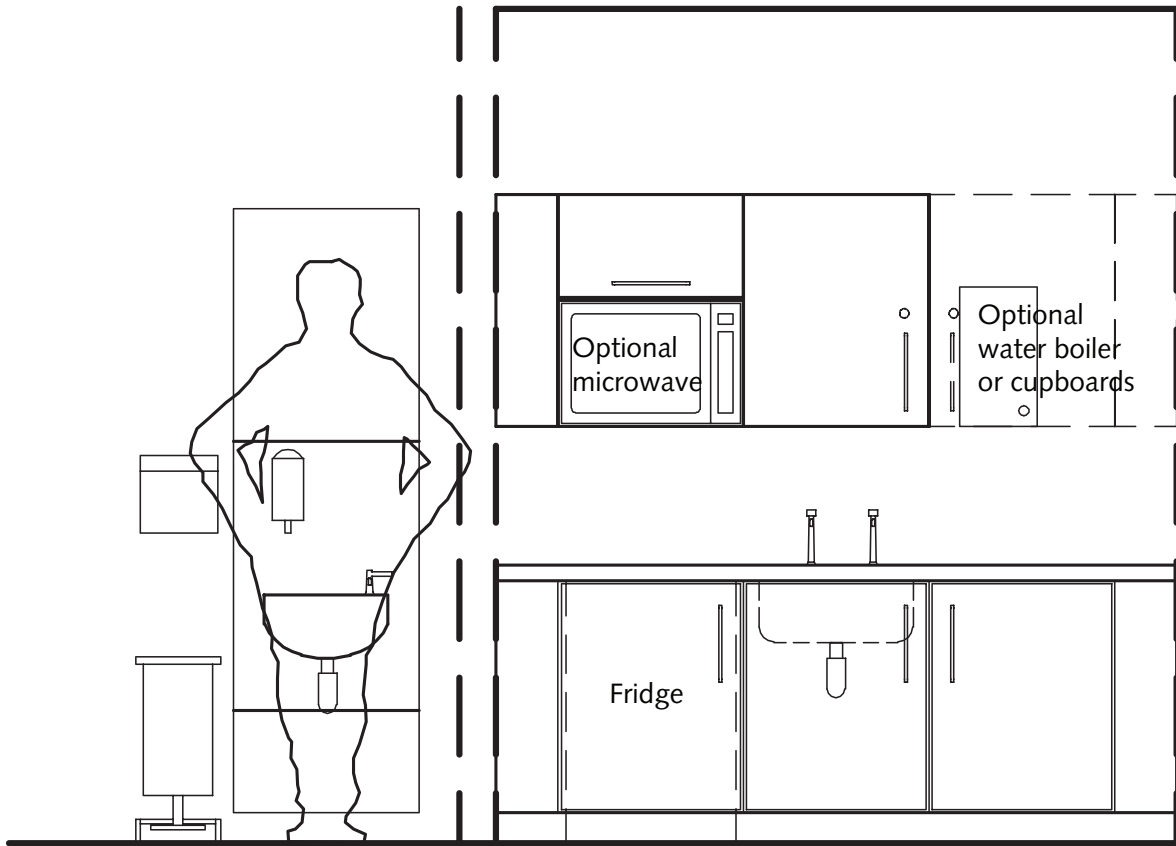

**Ergonomic drawings**

*Sink top*

**10.10** This ergonomic drawing (see Figure 91) shows the space requirements for a sink. Generally all sinks should have a worktop or drainer on either side.

**10.11** The recommended sink rim height is 950 mm for comfortable ergonomic access. Where it is

considered dangerous or unacceptable for the sink rim to be above the worktop, both should be at 900 mm, although this will result in taller users having to bend down to use the sink.

**10.12** For detailed information on sinks, see Health Building Note 00-10 Part C – ‘Sanitary assemblies’.

Figure 91 Space requirements for a sink

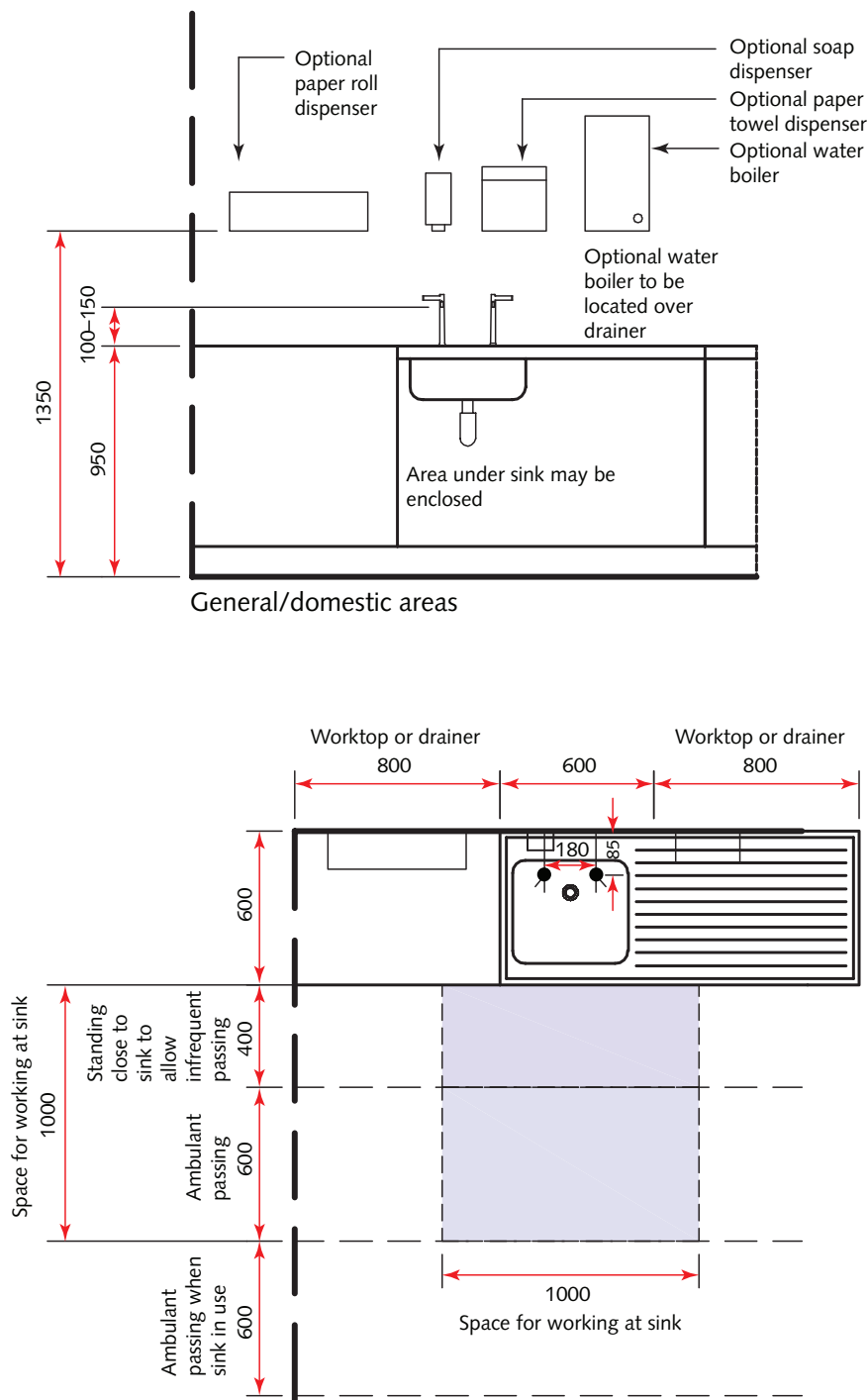

Standard base and wall cupboards

10.13 This ergonomic drawing (see Figure 92) shows the space requirements to access standard, floor mounted, base and wall cupboards. Where worktops or other obstructions project more than

500 mm, the reach dimensions illustrated relate to the front edge of the wall cupboard (that is, reaching into the cupboard would be difficult).

Figure 92 Space requirements to access standard, floor mounted base and wall cupboards

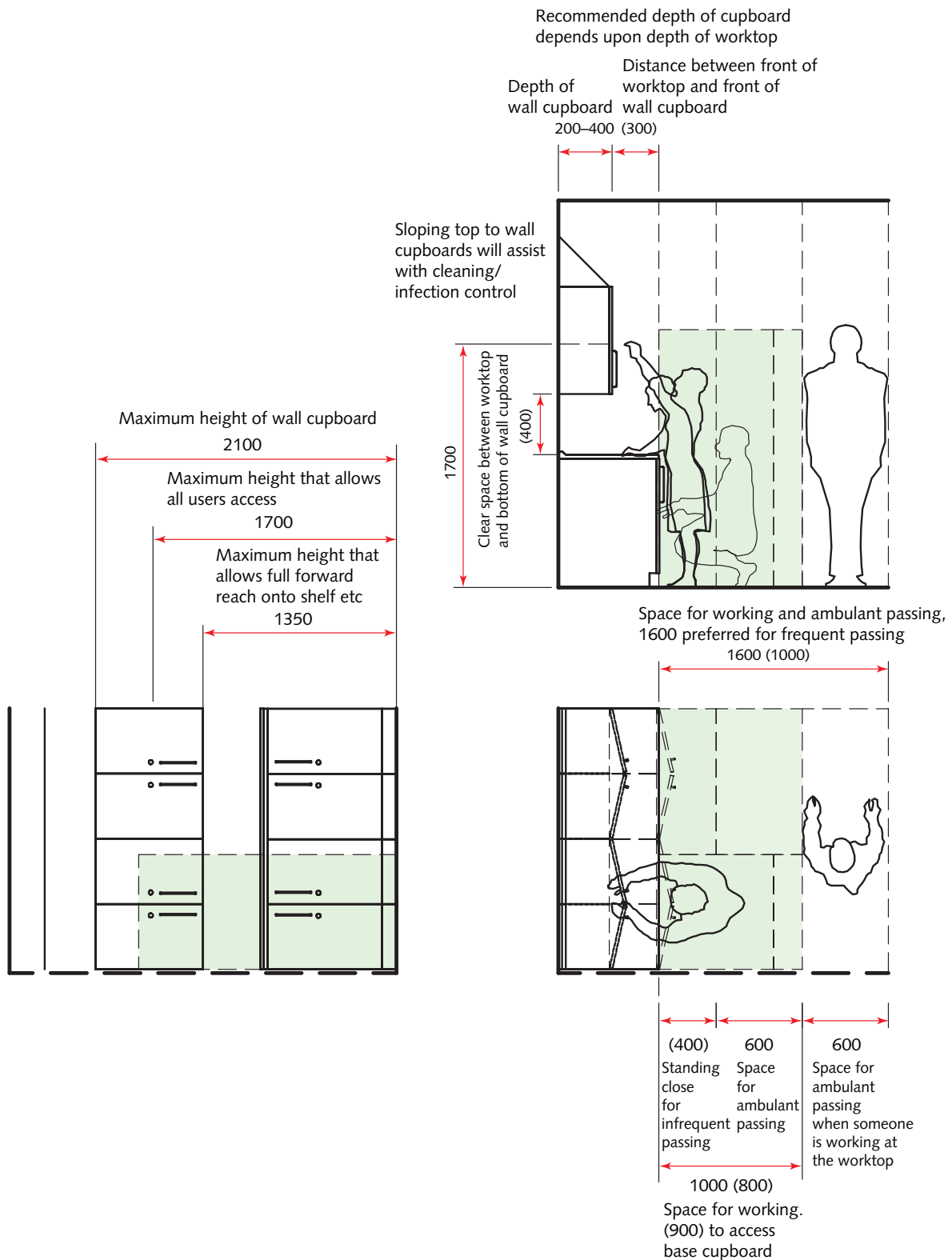



*Hand-rinse basin: ambulant*

10.14 This ergonomic drawing (see Figure 93) shows the space requirements for a 300 mm deep hand-rinse basin. It is suitable for ambulant and semi-ambulant use.

10.15 Hand-rinse basins are generally only suitable for rinsing hands under running water. They should have a single mixer tap.

Figure 93 Space requirements for a 300 mm deep hand-rinse basin

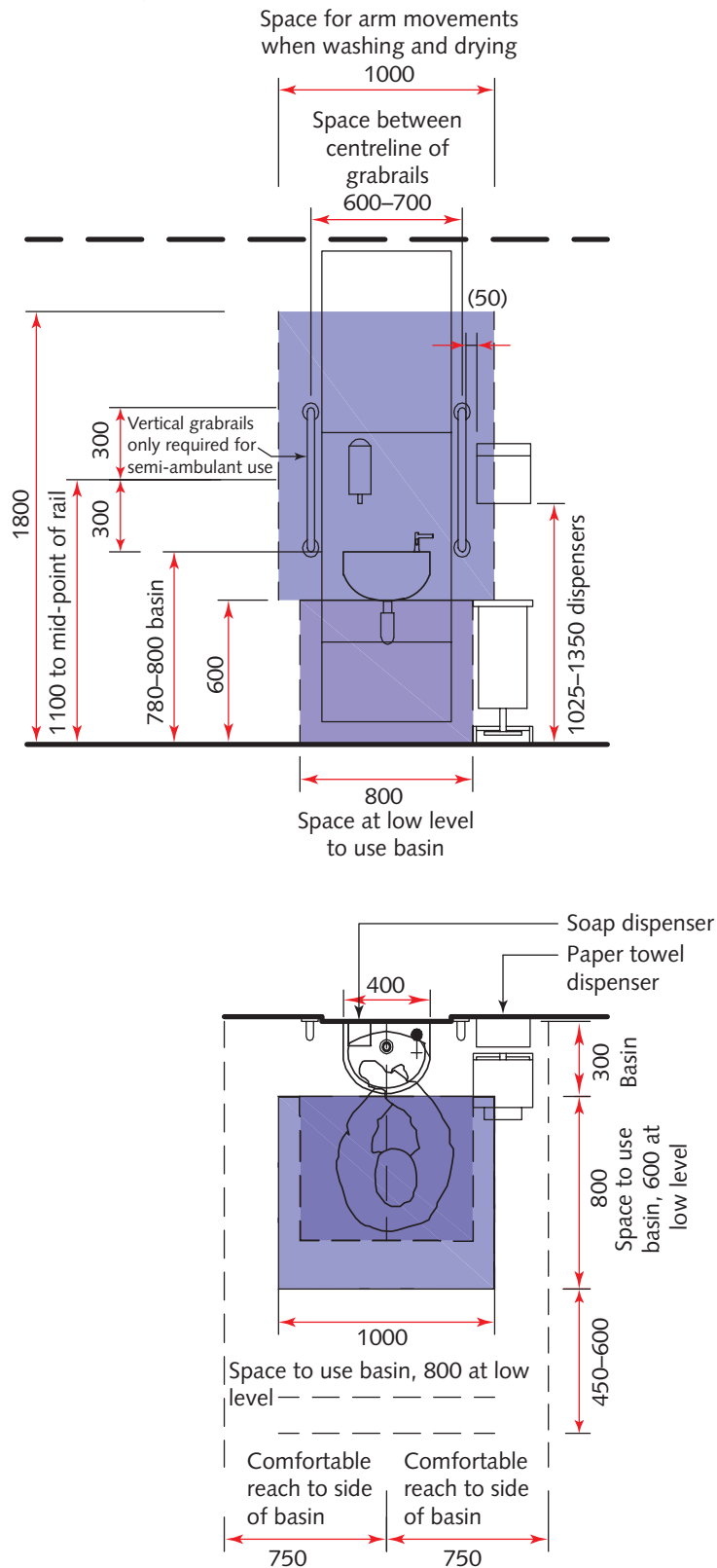

## Pantry/refreshment room

### Room description and layout

- 10.16 This room is for preparing snacks and beverages. Limited amounts of dry goods and refrigerated items will be stored here.
- 10.17 It may be located in staff, patient or visitor areas.
- 10.18 Facilities should meet all health and safety regulations.
- 10.19 Hand rinsing facilities must be provided wherever food is being prepared.
- 10.20 A hot water dispenser will be required.
- 10.21 Local policy will determine whether to include a microwave and/or dishwasher.
- 10.22 The room layout provided (see Figure 94) is only suitable for ambulant and semi-ambulant access. Where wheelchair access is required, the room needs to be bigger, worktops will need to be lowered and the cupboards under the sink removed. See Approved Document M and BS 8300 for further guidance.

Figure 94 Space requirements for ambulant and semi-ambulant access to pantry/refreshment room



Ergonomic drawings

Sink top

10.23 This ergonomic drawing (see Figure 95) shows the space requirements for a sink. Generally all sinks should have a worktop or drainer on either side.

10.24 The recommended sink rim height is 950 mm for comfortable ergonomic access. Where it is

considered dangerous or unacceptable for the sink rim to be above the worktop, both should be at 900 mm, although this will result in taller users having to bend down to use the sink.

10.25 For detailed information on sinks, see Health Building Note 00-10 Part C – ‘Sanitary assemblies’.

Figure 95 Space requirements for a sink

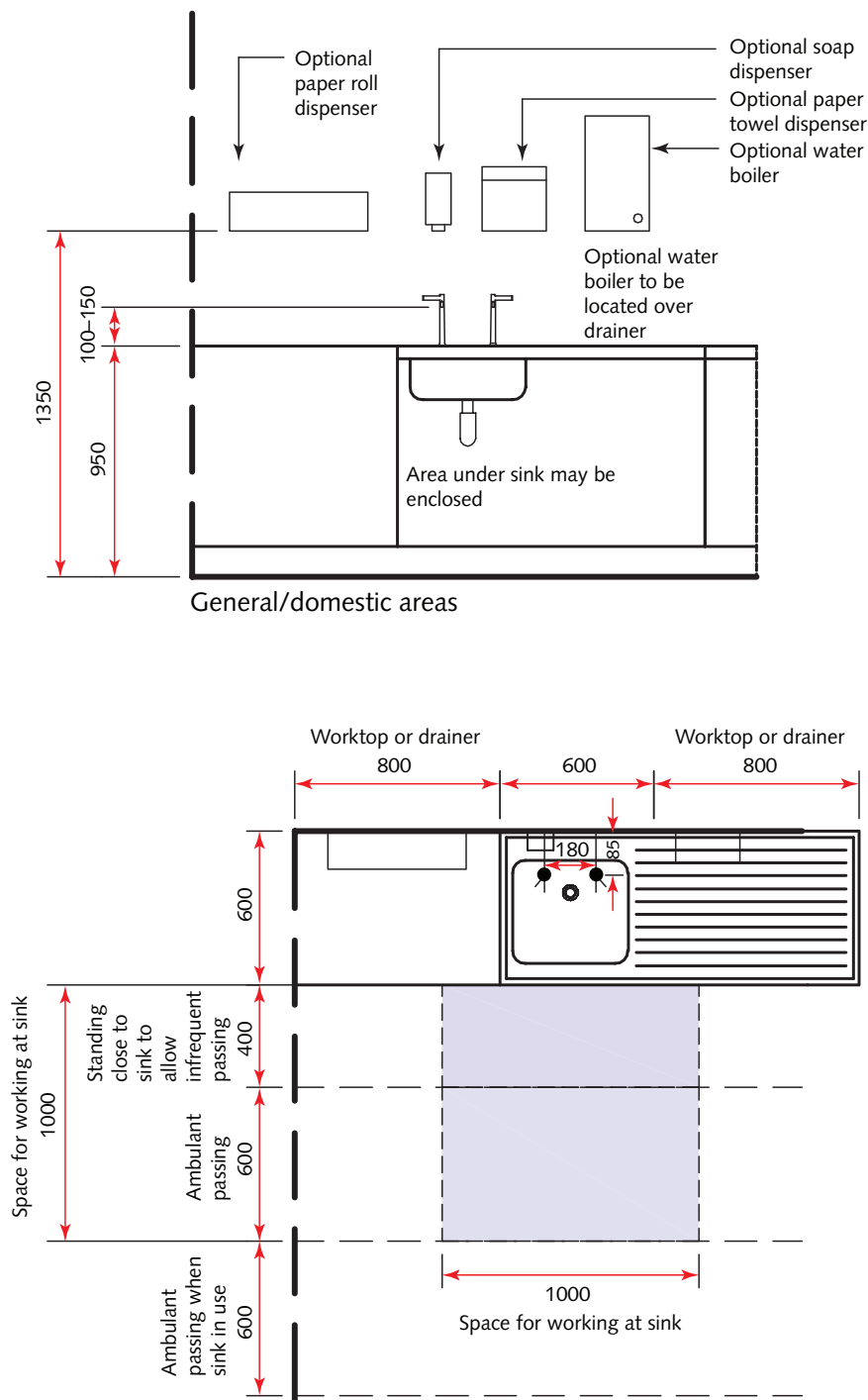

Standard base and wall cupboards

10.26 This ergonomic drawing (see Figure 96) shows the space requirements to access standard, floor mounted, base and wall cupboards. Where worktops or other obstructions project more than

500 mm, the reach dimensions illustrated relate to the front edge of the wall cupboard (that is, reaching into the cupboard would proved difficult).

Figure 96 Space requirements to access standard, floor mounted base and wall cupboards

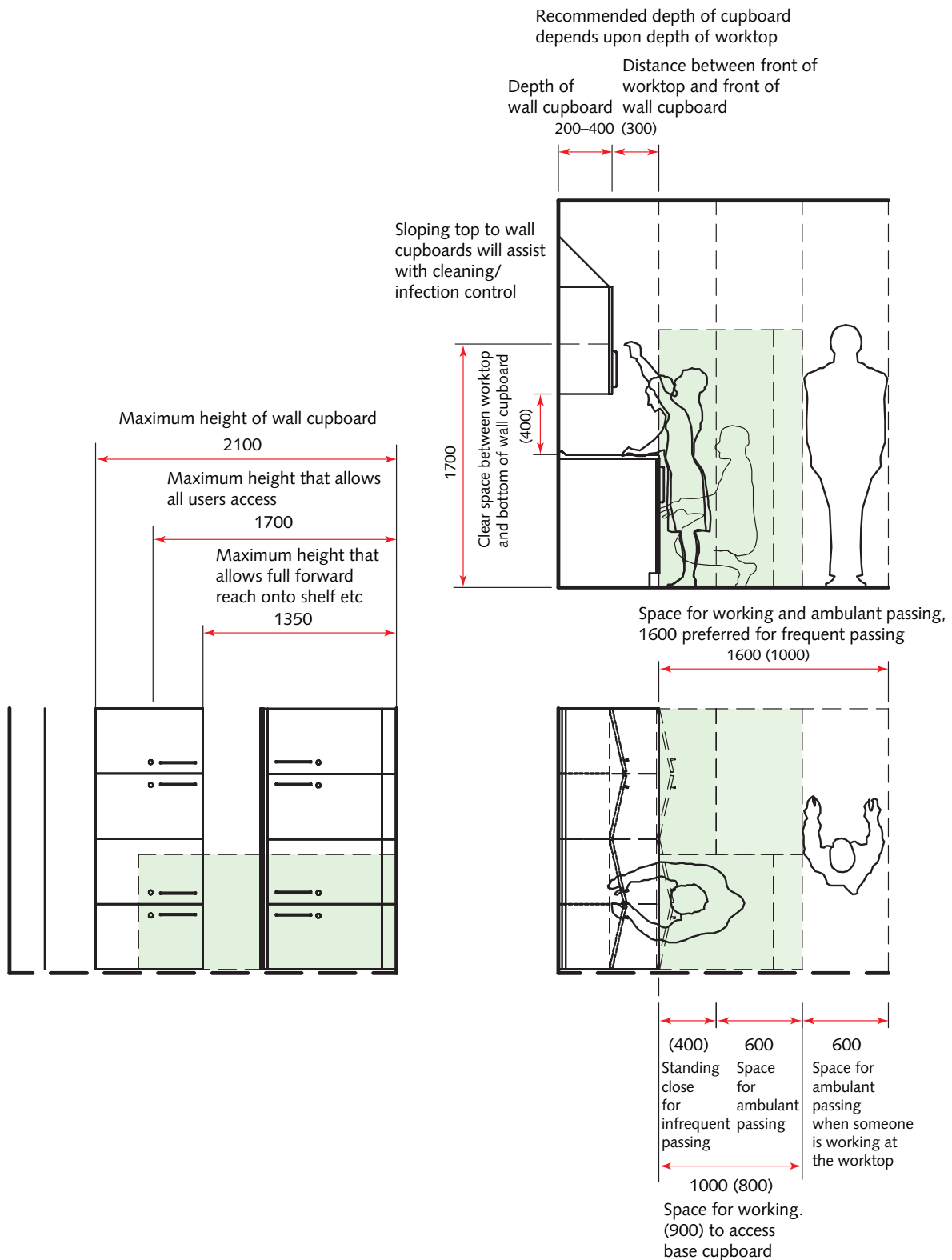

*Hand-rinse basin: ambulant*

10.27 This ergonomic drawing (see Figure 97) shows the space requirements for a 300 mm deep hand-rinse basin. It is suitable for ambulant and semi-ambulant use.

10.28 Hand-rinse basins are generally only suitable for rinsing hands under running water. They should have a single mixer tap.

Figure 97 Space requirements for a 300 mm deep hand-rinse basin

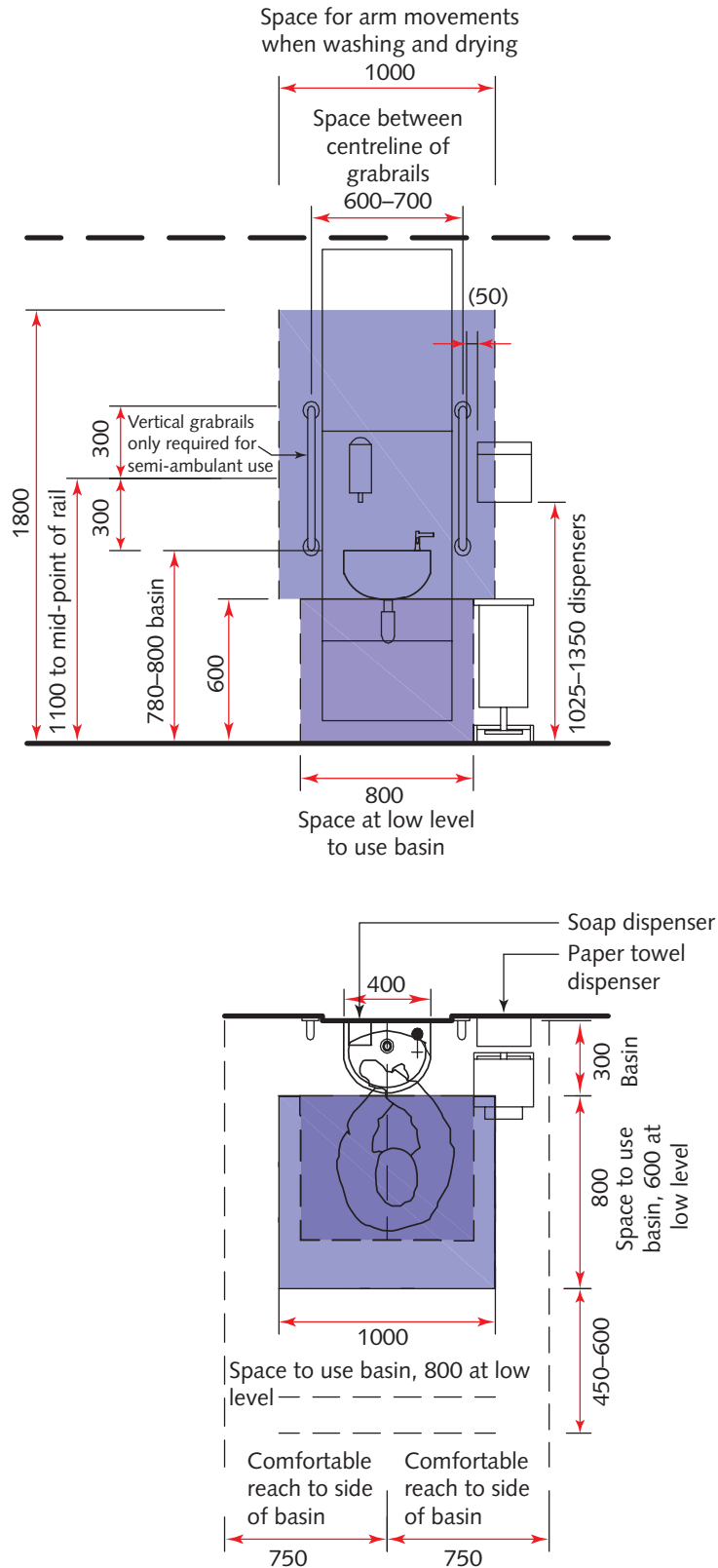

## Rest room with mini kitchen

### Room description and layout

- 10.29 A rest room is intended as a generic space that may be used by staff, visitors or patients.
- 10.30 Where rest rooms are provided for staff, they should be located away from public areas.
- 10.31 The size of the space should be based on the maximum number of users that will need to be in the room at any one time.
- 10.32 Local policy will determine the choice of furniture. A TV may be provided.
- 10.33 Natural light and ventilation should be provided.
- 10.34 The room layout provided (see [Figure 98](#)) is suitable for ambulant use only. It includes separate zones for sitting (14 places) and dining (4 places).
- 10.35 For sizing rest rooms (for ambulant use only) the following allowances may be used:
- 1.5 m<sup>2</sup> per easy chair or dining chair (and part use of table);
  - 5 m<sup>2</sup> for the mini kitchen.
- 10.36 Where wheelchair users can be expected, 3 m<sup>2</sup> per wheelchair space needs to be provided for sitting or dining and the beverage space will need to be increased. See BS 8300 and Approved Document M.
- 10.37 For briefing purposes, rest rooms for ambulant use with 15–50 seating places may be sized at 1.8 m<sup>2</sup> per place. This allows for any combination of dining places and seating places and for a mini kitchen or pantry/refreshment area.
- 10.38 For rest rooms with fewer than 29 seats, it has been assumed that a mini kitchen will be used. For rest room with 30 or more seats, it has been assumed that a separate pantry/refreshment area(s) will be used.
- 10.39 The allowance of 1.8 m<sup>2</sup> is the average figure from the calculations below.
- 10.40 Where a rest room with fewer than 15 seats is required, the option of creating a larger shared space should be considered for efficiency and flexibility.

**Table 2 Rest room sizes**

<b>Rest room: 15 places</b>				
<b>Component spaces</b>	<b>Qty</b>	<b>Unit area allowance (m<sup>2</sup>)</b>	<b>Total area (m<sup>2</sup>)</b>	<b>Rest room allowance (m<sup>2</sup>)</b>
Ambulant dining/seating area	15	1.5	22.5	
Mini kitchen	1	5.5	5.5	
<b>Net allowance</b>			<b>28</b>	<b>1.9 per place</b>
<b>Rest room: 18 places</b>				
<b>Component spaces</b>	<b>Qty</b>	<b>Unit area allowance (m<sup>2</sup>)</b>	<b>Total area (m<sup>2</sup>)</b>	<b>Rest room allowance (m<sup>2</sup>)</b>
Ambulant dining/seating area	18	1.5	27	
Mini kitchen	1	5.5	5.5	
<b>Net allowance</b>			<b>32.5</b>	<b>1.8 per place</b>
<b>Rest room: 30 places</b>				
<b>Component spaces</b>	<b>Qty</b>	<b>Unit area allowance (m<sup>2</sup>)</b>	<b>Total area (m<sup>2</sup>)</b>	<b>Rest room allowance (m<sup>2</sup>)</b>
Ambulant dining/seating area	30	1.5	45	
Pantry/refreshment area	1	8	8	
<b>Net allowance</b>			<b>53</b>	<b>1.8 per place</b>
<b>Rest room: 50 places</b>				
<b>Component spaces</b>	<b>Qty</b>	<b>Unit area allowance (m<sup>2</sup>)</b>	<b>Total area (m<sup>2</sup>)</b>	<b>Rest room allowance (m<sup>2</sup>)</b>
Ambulant dining/seating area	50	1.5	75	
Pantry/refreshment area	2	8	16	
<b>Net allowance</b>			<b>91</b>	<b>1.8 per place</b>

Figure 98 Space requirements for ambulant access to rest room with mini-kitchen

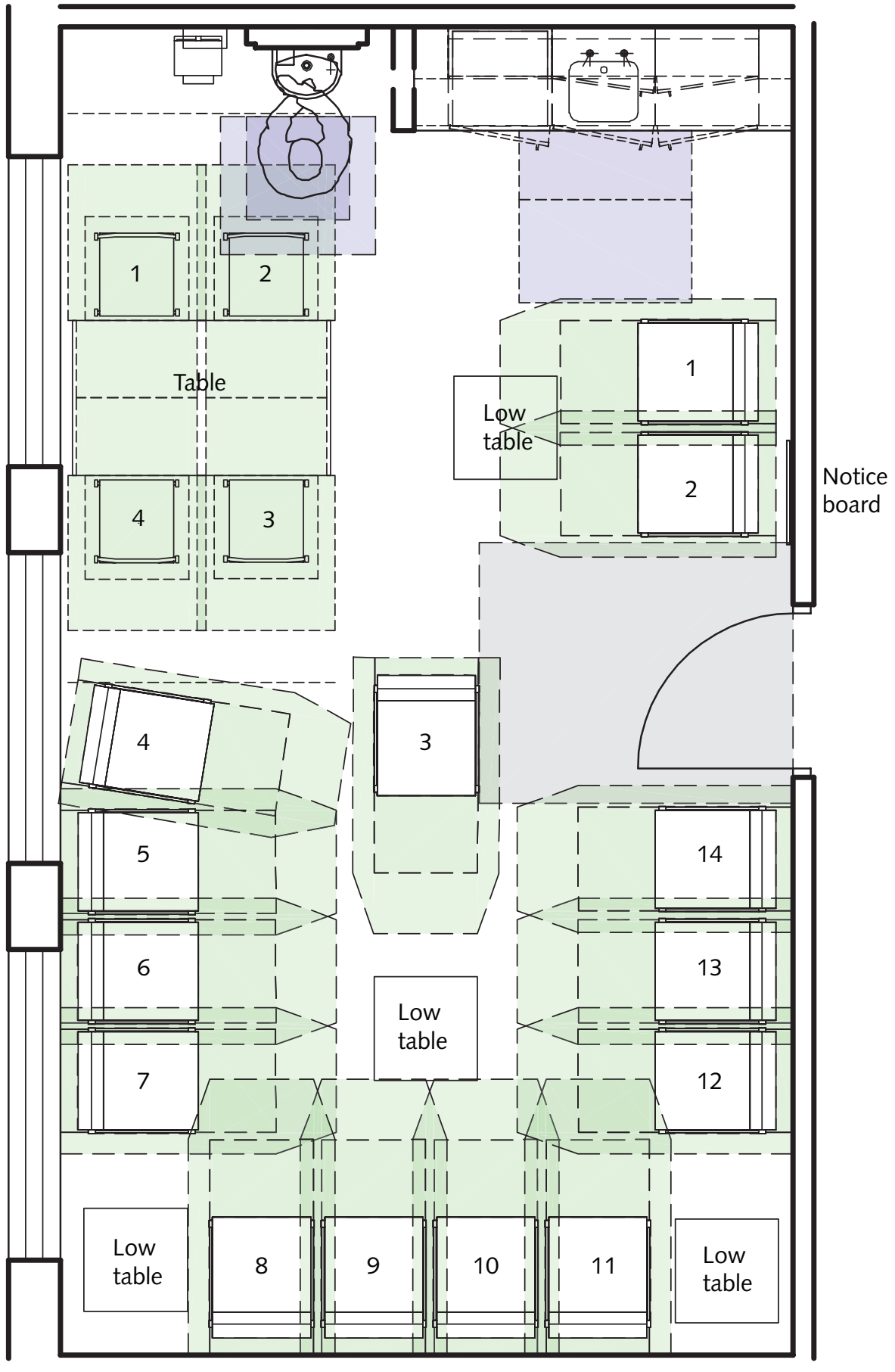

**Ergonomic drawings**

*Space to sit on an easy chair*

10.41 These ergonomic drawings (see Figure 99) show the space requirements for a person to sit on an easy chair.

10.42 When seats are pushed together in rows, the average seat width is 600–650 mm for seats without arms and 750 mm for seats with arms.

Figure 99 Space requirements to sit on an easy chair

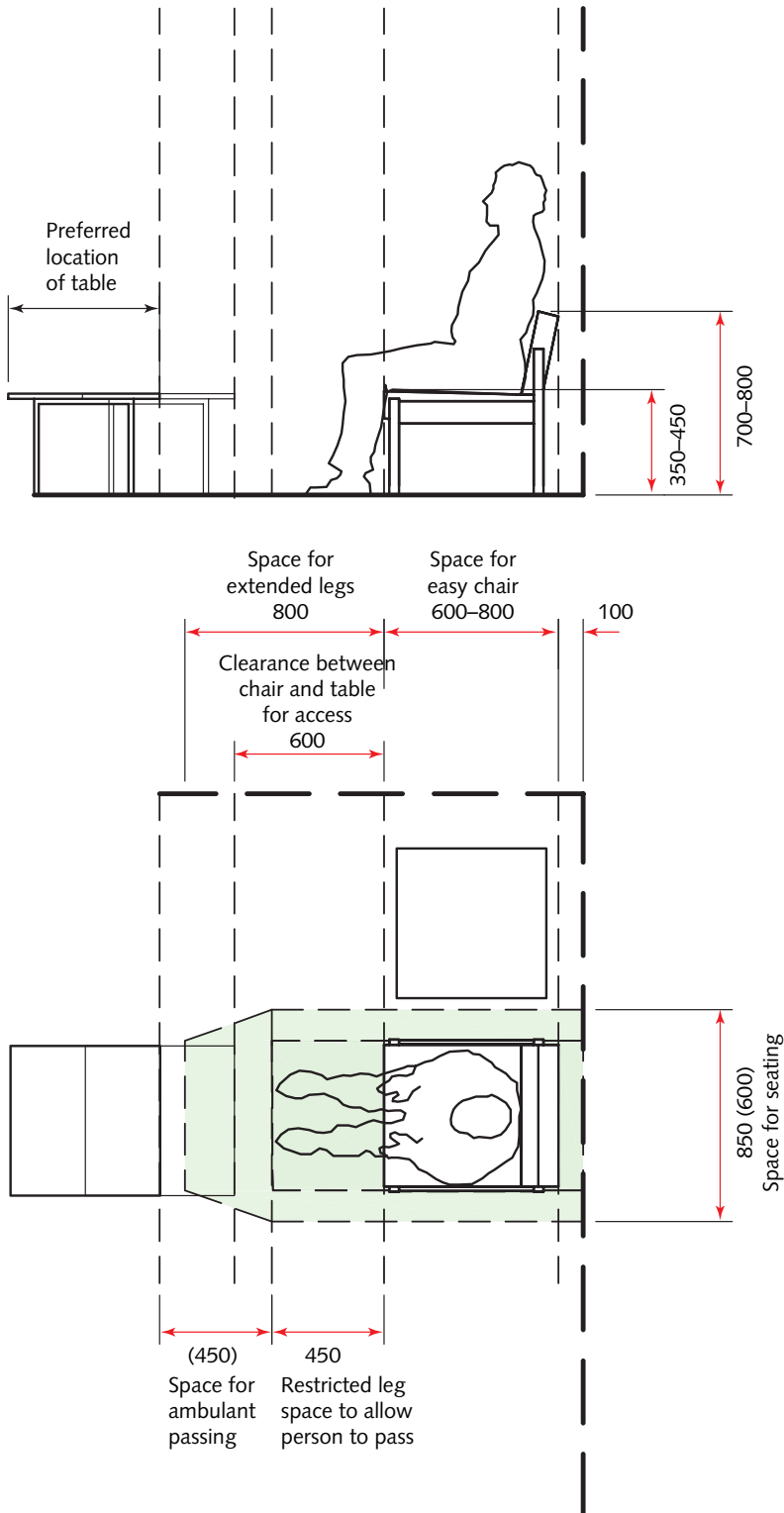



*Dining table*

10.43 This ergonomic drawing (see Figure 100) shows the space requirements for dining at a table i.e. space for a place setting at a table/minimum table size to allow use.

10.44 A dining table and chairs is included in the indicative room layouts of the staff rest room.

Figure 100 Space requirements for dining at a table

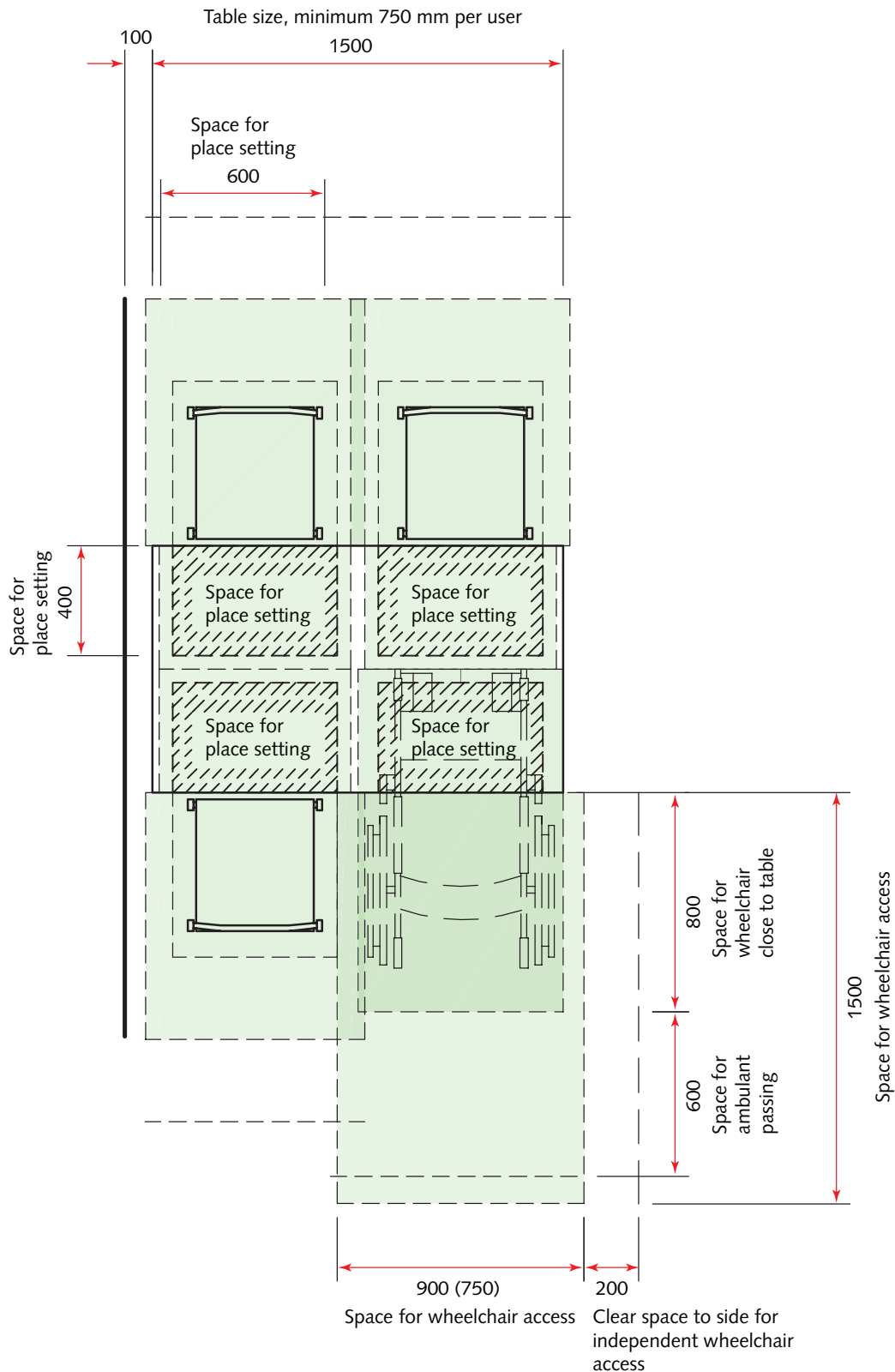

*Wash-hand basin: ambulant*

- 10.45 Wash-hand basins may be used for personal washing activities.
- 10.46 This ergonomic drawing (see Figure 101) shows the space requirements for ambulant/semi-ambulant use of a 400 mm deep x 500 mm wide wash-hand basin.
- 10.47 It includes a shaver socket adjacent to the wash-hand basin and a light above the mirror; these are

optional. The inclusion of a shaver socket depends on project requirements. The need for a local light depends on the overall lighting scheme within the room.

- 10.48 The drawing also shows two short lever taps. Alternatively a single mixer tap or sensor-operated taps may be used. See 'Health Building Note 00-10 Part C – 'Sanitary assemblies' for details.

Figure 101 Space requirements for ambulant/semi-ambulant use of a 400 mm deep x 500 mm wide wash-hand basin

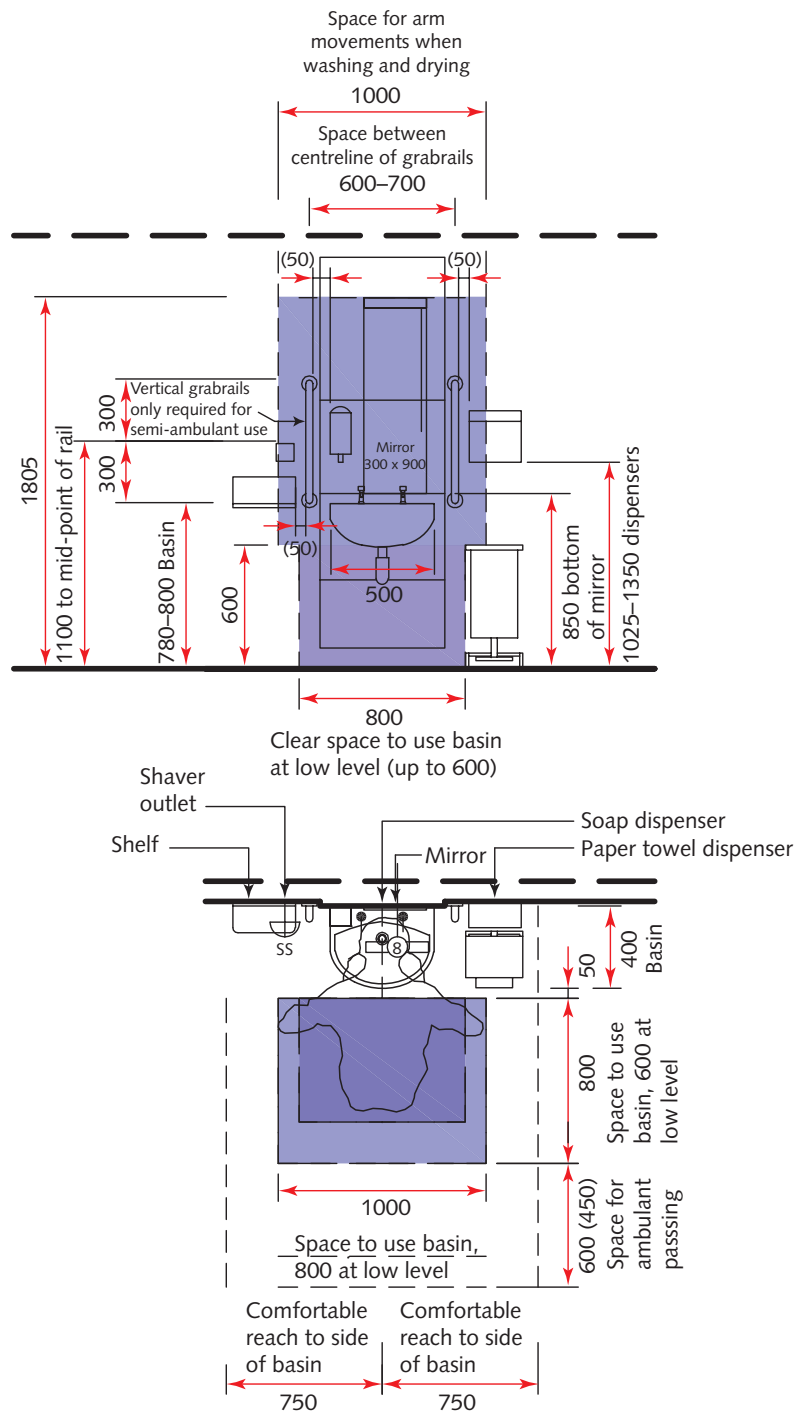

## 11 Generic clinical support spaces: Miscellaneous

### Near patient testing room

#### Room description and layout

- 11.1 This room is used to carry out tests on body fluids (for example urea, electrolytes, blood sugar, blood gases etc) that require instant results.
- 11.2 The sink will be required if demineralised water is needed. Requirements for demineralised water will depend on the type of equipment used.
- 11.3 A dedicated pneumatic tube link to the main pathology laboratory may be provided to allow specimens to be sent for more complex analysis.
- 11.4 A specimen fridge will be required where samples have to be stored before sending to the main pathology laboratories.
- 11.5 Specialist advice should be sought to ensure compliance with CoSHH Regulations.
- 11.6 Two room layouts have been provided (see [Figures 102 and 103](#)).
- 11.7 Both layouts show an outward opening door. The need to include a door depends on the location and security of the space. Where an outward opening door is provided, it must not open onto a circulation route.
- 11.8 Both layouts also include zones for blood sample testing, computer access and clinical hand washing.
- 11.9 A sharps bin should be located on the laboratory bench. A stool may be provided in place of the laboratory chair.
- 11.10 The illustrated space requirements for accessing modular base and upper cabinets is based on space to access standard cupboards, not using baskets or trays. However, adequate space is available for side access to baskets or trays.

Figure 103 Near patient testing room (option 2)

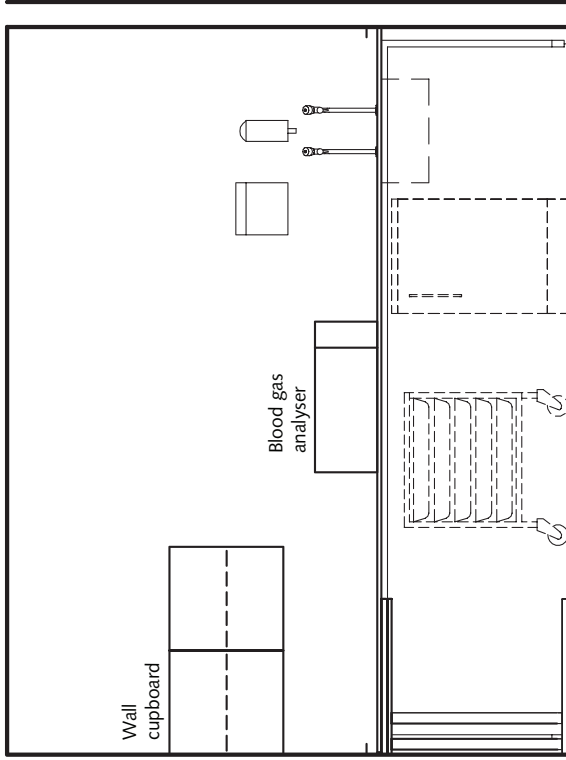
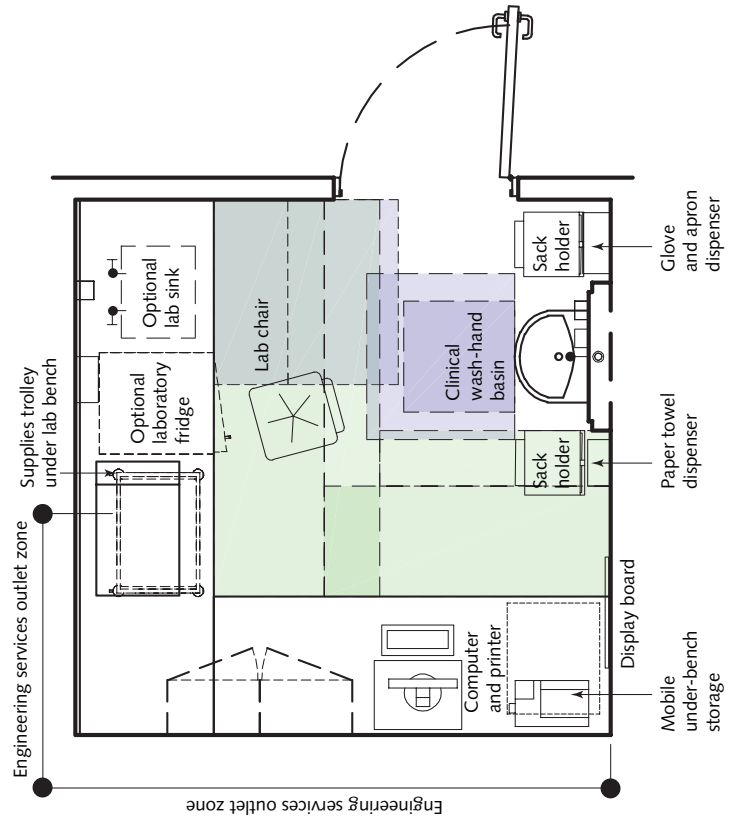
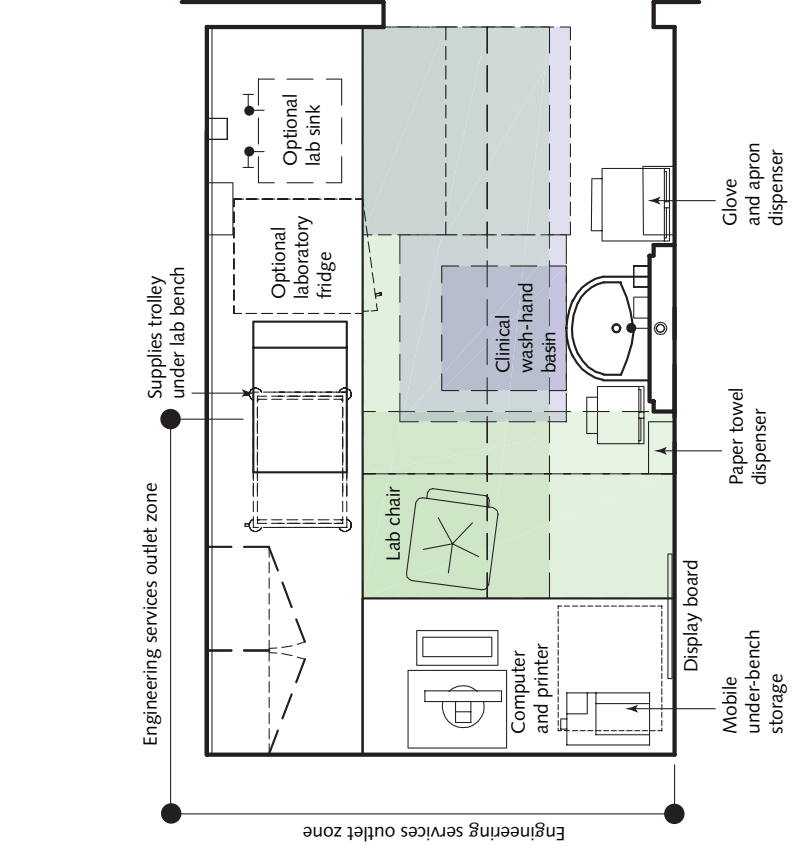
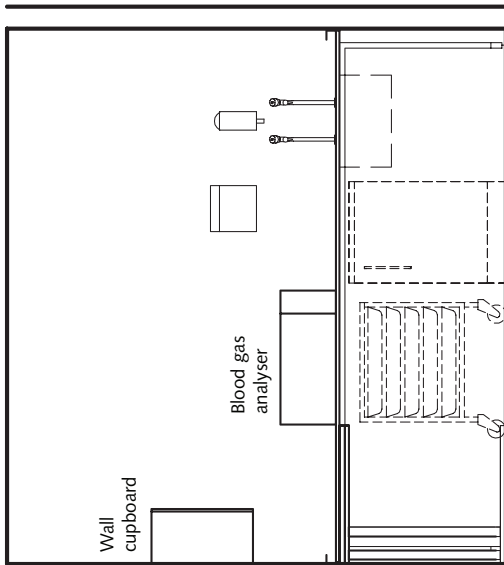

Figure 102 Near patient testing room (option 1)



## Ergonomic drawings

### Clinical wash-hand basin

11.11 These ergonomic drawings (see Figure 104) show the space requirements for standing use of a clinical wash-hand basin assembly. For seated use, the basin will need to be lowered.

11.12 The basin should be fitted with non-touch taps.

11.13 The recommended fixing height of a lever tap on a clinical wash-hand basin is 1095 mm. Where a lever tap is used, the fixing height of the dispensers should be chosen to reduce any possible conflicts in use.

11.14 The illustrated clinical wash-hand basin projects 400 mm from the back panel or wall. However, clinical wash-hand basins may vary from 350 to 500 mm projection. Where basins deeper than 400 mm are used, the impact on/from other components and/or activities undertaken within any space should be considered when evaluating any room layout.

11.15 The glove and apron dispenser illustrated is a combined unit; this is considered the most compact solution although separate units may also be used. Even the most compact unit cannot practically be located within comfortable reach of the basin; it should, however, be conveniently located within the room.

11.16 The ergonomic advice for the height of horizontal elbow operated lever taps is based on the following data:

“Elbow height for shod, slightly bent posture (as when leaning forward) for 50%ile UK male = 1134 mm, for female 1049 mm. 1090 mm is considered the best compromise for an elbow height for both male and female use. The ergonomic advice for the height of a lever tap is 75 mm below elbow height giving a figure height of approx 1015 mm.”

11.17 Lever taps are not illustrated.

11.18 For detailed information on basins, see Health Building Note 00-10 Part C – ‘Sanitary assemblies’.

Figure 104 Space requirements for standing use of a clinical wash-hand basin assembly

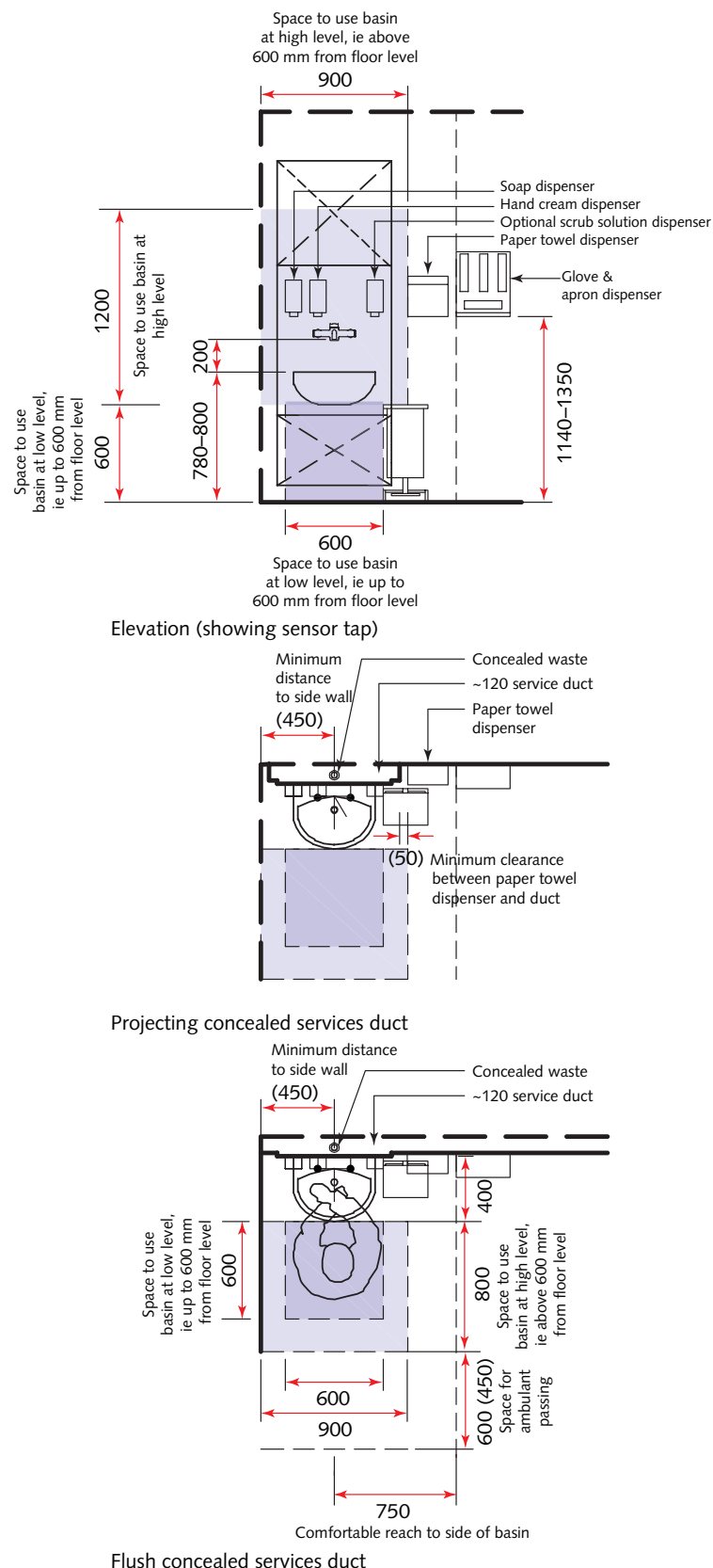

Standard base and wall cupboards

11.19 This ergonomic drawing (see Figure 105) shows the space requirements to access standard, floor mounted, base and wall cupboards. Where worktops or other obstructions project more than

500 mm, the reach dimensions illustrated relate to the front edge of the wall cupboard (that is, reaching into the cupboard would prove difficult).

Figure 105 Space requirements for access to standard, floor mounted base and wall cupboards

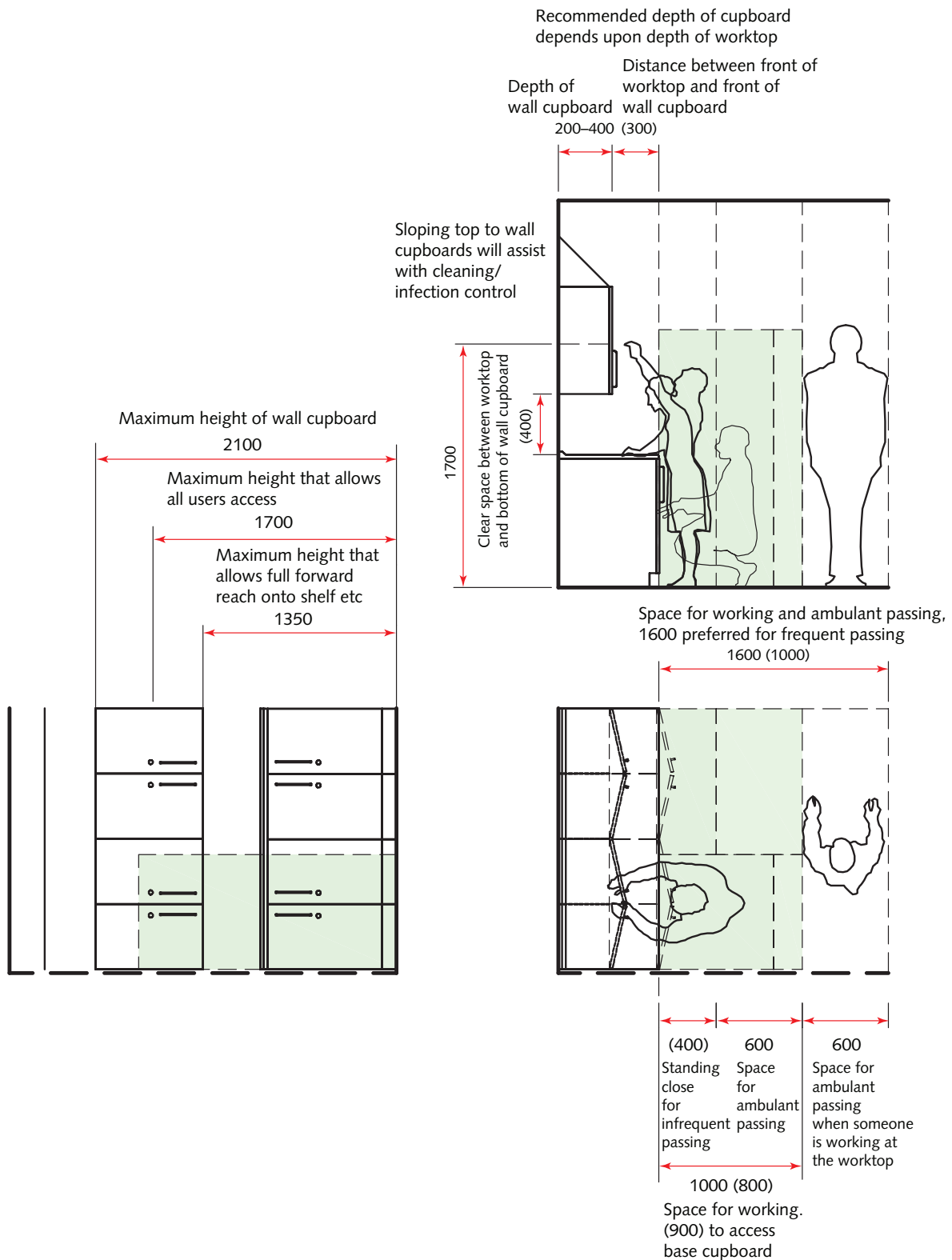

## Parking bay

### Room description

- 11.20 Parking bays are used to hold mobile equipment when not in use. The bays should be easily accessible and close to areas served. Their location should not disrupt circulation routes.
- 11.21 Generally a bay of 2 m<sup>2</sup> with a power supply for recharging equipment is sufficient.
- 11.22 The design of the bay should reflect the area in which it is located. It may be painted in a different colour to the surrounding area if it needs to be quickly identifiable. Alternatively, its ceiling height may be raised to that of the surrounding area in order to blend in.
- 11.23 No room layout has been provided.

## Relatives' overnight stay

### Room description and layout

- 11.24 This room is for sleeping only. It should be able to accommodate two people.
- 11.25 Access is required to beverage-making facilities.
- 11.26 It should be combined with an en-suite shower and toilet.
- 11.27 The room layout provided (see Figure 106) includes a single divan bed and a separate single sofa bed, for a maximum of two adults, including one wheelchair user.

Figure 106 Space requirements for relatives' overnight stay, single divan bed and separate single sofa bed

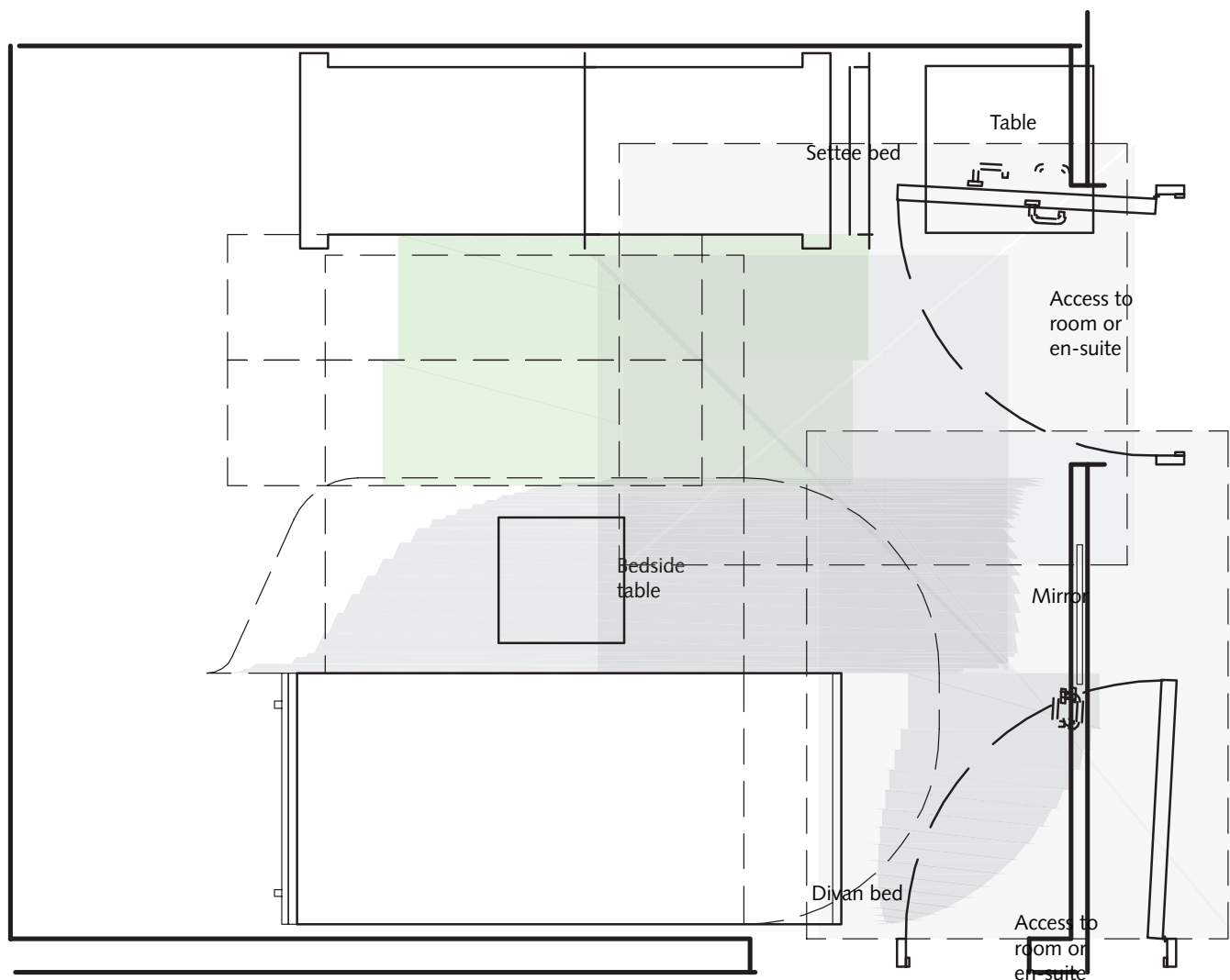

## Ergonomic drawings

### *Space to access a divan bed*

11.28 This ergonomic drawing (see Figure 107) shows the space requirements for wheelchair and ambulant access to a divan bed.

Figure 107 Space requirements to access a divan bed

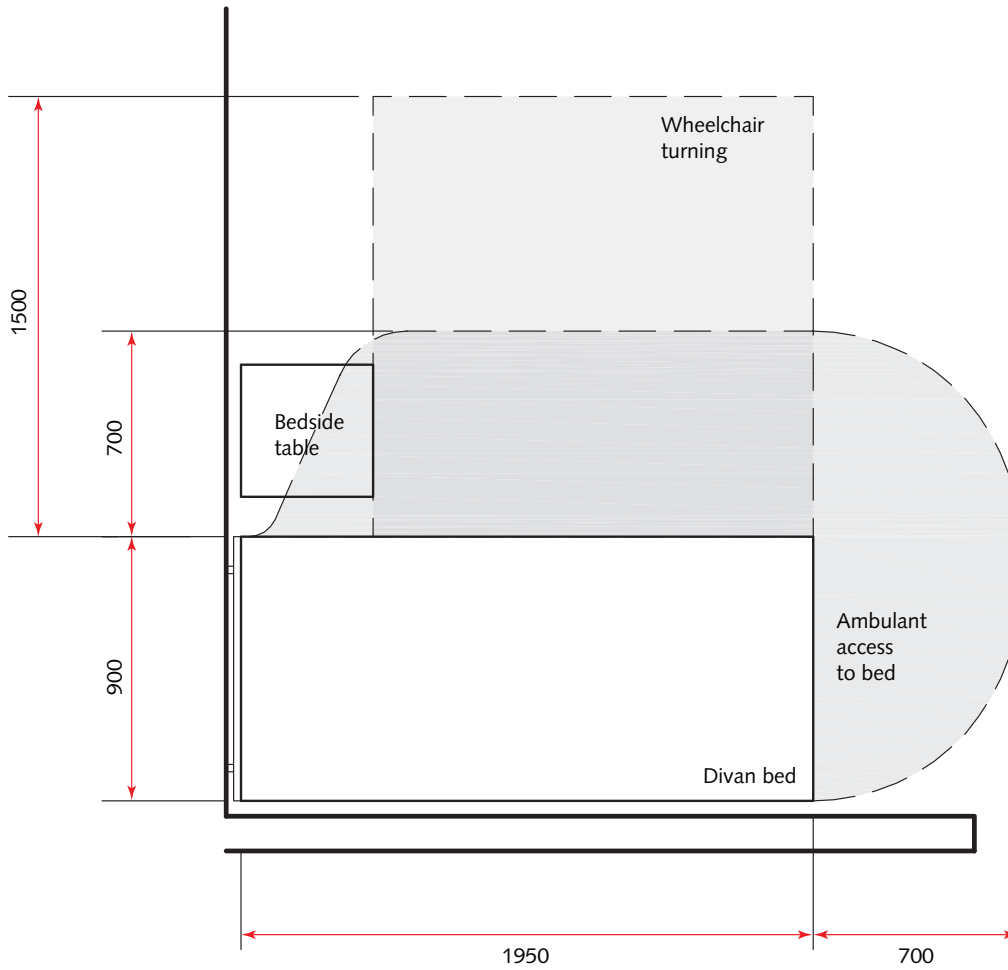



## 12 Generic clinical admin spaces: Open-plan admin areas

### Admin area: continuous use

#### Room description and layout

- 12.1 This area is suitable for full-time office-based staff.
- 12.2 The layout provided (see [Figure 108](#)) includes eight dedicated workstations.
- 12.3 Each workstation space includes a lockable filing cabinet and lockable desk-high storage unit for staff personal belongings, for example laptop, mobile phone etc.
- 12.4 The continuous use administration area as defined here excludes:
- significant clinical or administrative storage space;
  - local printing facilities (as these are not considered appropriate for sustainability reasons).
- 12.5 For sizing continuous use open plan administration areas (with six or more workstations) an allowance of 5 m<sup>2</sup> per workstation may be used.
- 12.6 In order to function properly, a series of support spaces are recommended where workstations are provided within open plan areas.
- 12.7 For briefing purposes, open-plan offices with eight or more workstations may be sized at 6.6 m<sup>2</sup> per workstation. This allows for the following:
- space for the workstation;
  - one interview room (4 places) for every 16 workstations;
  - one quiet workspace for every 16 workstations (not included within base standard if eight or fewer workstations);
  - one breakout space for every 16 workstations (not included within base standard if eight or fewer workstations);
  - one photocopy/printing room, with multifunctional printer/copier and storage for paper/printing supplies, for every 32 workstations.
- 12.8 The allowances include access space within the open plan area but exclude external circulation space.
- 12.9 The allowance of 6.6 m<sup>2</sup> is the average figure from the calculations below.
- 12.10 The breakout space is not essential where dedicated workstations are provided but is recommended for flexibility in use.
- 12.11 Open-plan areas with their associated support spaces have similar net space requirements per workstation to 2-person offices. However, open-plan areas are considered more flexible and have lower circulation requirements.

Figure 108 Space requirements for eight dedicated workstations, administration area

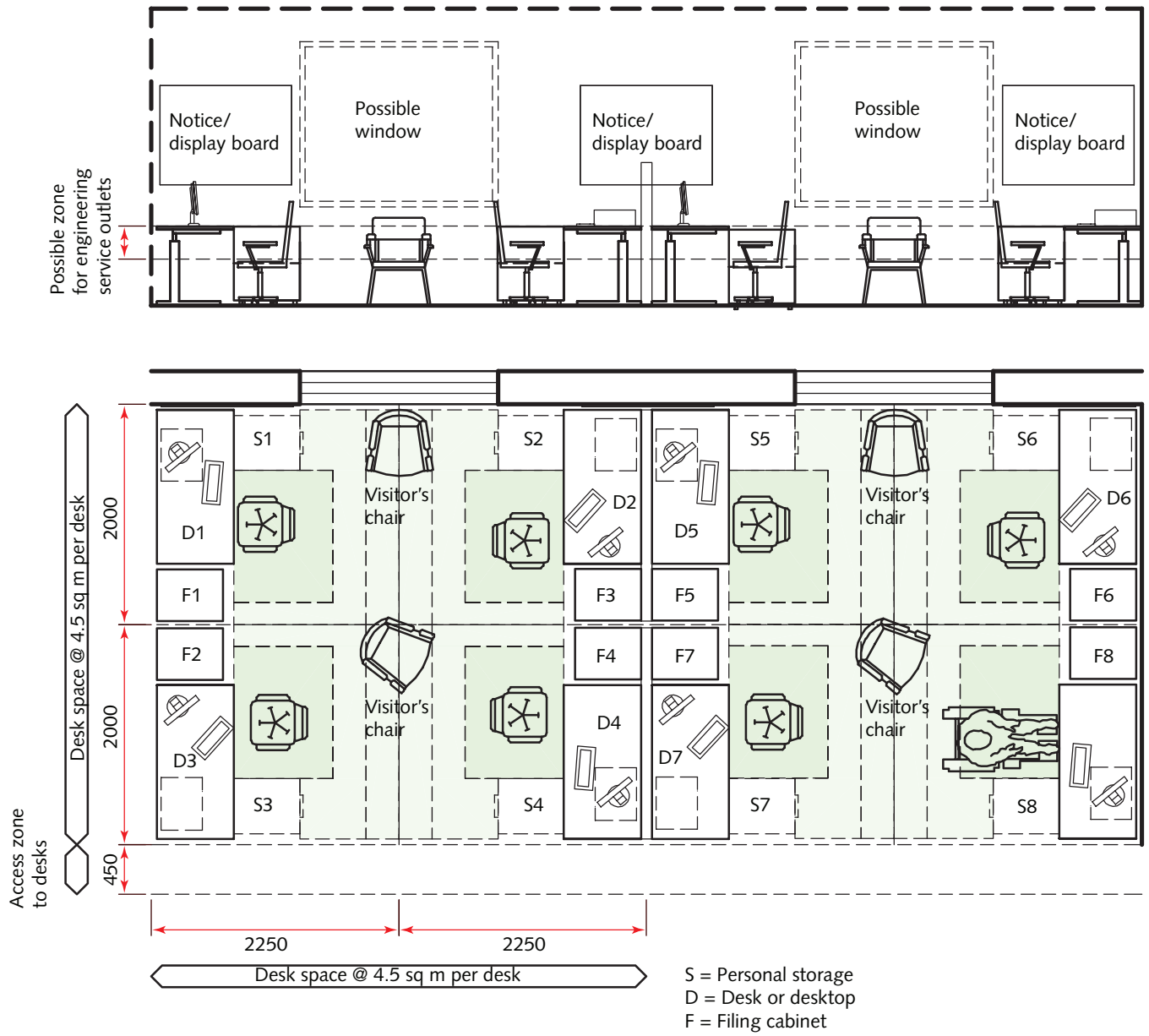

Table 3 Open-plan office sizes

<b>Open-plan office space: 8 workstations</b>				
<b>Component spaces</b>	<b>Qty</b>	<b>Unit area allowance (m<sup>2</sup>)</b>	<b>Total are (m<sup>2</sup>)</b>	<b>Open-plan office allowance (m<sup>2</sup>)</b>
Dedicated workstations	8	5.0	40.0	
Photocopy/printing room	1	6.0	6.0	
Breakout space	0	6.0	0.0	
Quiet workspace	0	5.5	0.0	
Interview room	1	8.0	8.0	
<b>Net allowance</b>			<b>54.0</b>	<b>6.8 per workstation</b>
<b>Open-plan office space: 64 dedicated workstations</b>				
<b>Component spaces</b>	<b>Qty</b>	<b>Unit area allowanc (m<sup>2</sup>)</b>	<b>Total area (m<sup>2</sup>)</b>	<b>Open-plan office allowance (m<sup>2</sup>)</b>
Dedicated workstations	64	5.0	320.0	
Photocopy/printing room	2	6.0	12.0	
Breakout space	4	6.0	24.0	
Quiet workspace	4	5.5	22.0	
Interview room	4	8.0	32.0	
<b>Net allowance</b>			<b>410.0</b>	<b>6.4 per workstation</b>
<b>Open-plan office space: 8 shared workstations (32 staff)</b>				
<b>Component spaces</b>	<b>Qty</b>	<b>Unit area allowance (m<sup>2</sup>)</b>	<b>Total area (m<sup>2</sup>)</b>	<b>Open-plan office allowance (m<sup>2</sup>)</b>
Shared workstations	8	5.0	40.0	
Photocopy/printing room	1	6.0	6.0	
Breakout space	0	6.0	0.0	
Quiet workspace	0	5.5	0.0	
Interview room	1	8.0	8.0	
<b>Net allowance</b>			<b>54.0</b>	<b>6.8 per workstation</b>
<b>Open-plan office space: 60 shared workstations (240 staff)</b>				
<b>Component spaces</b>	<b>Qty</b>	<b>Unit area allowance (m<sup>2</sup>)</b>	<b>Total area (m<sup>2</sup>)</b>	<b>Open-plan office allowance (m<sup>2</sup>)</b>
Shared workstations	60	5.0	300.0	
Photocopy/printing room	2	6.0	12.0	
Breakout space	4	6.0	24.0	
Quiet workspace	4	5.5	22.0	
Interview room	4	8.0	32.0	
<b>Net allowance</b>			<b>390.0</b>	<b>6.5 per workstation</b>

**Ergonomic drawings**

*Administration workstation*

12.12 This ergonomic drawing (see Figure 109) shows the space requirements for an administration workstation.

12.13 Office furniture should comply with BS EN 1335-1.

12.14 Desks should include wire management and equipment should be able to be plugged in at desk height. Task lighting should be considered.

12.15 The 900 mm space required to withdraw a chair from the desk will increase to 1000 mm for heavy upholstered chairs.

12.16 Where there is frequent passing behind a desk, the preferred 1500 mm space should be provided. This will also allow for wheelchair access.

Figure 109 Space requirements for an administration workstation

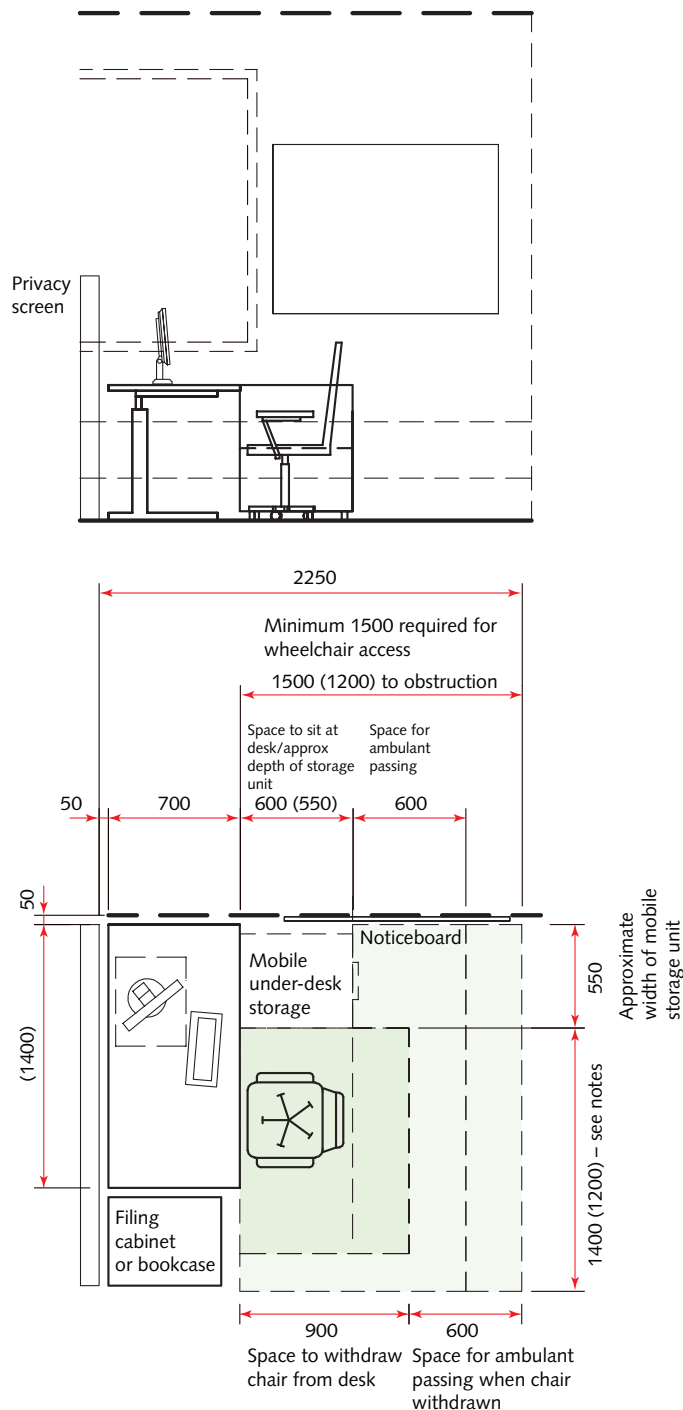

## Admin area: shared use

### Room description and layout

- 12.17 The layout provided (see [Figure 110](#)) includes eight shared workstations.
- 12.18 The layout is based on four people sharing a workstation. There are four dedicated lockable desk-high storage units for each workstation (i.e. one for each person).
- 12.19 The provision of DDI number access to phone systems may help to enable the shared use of workstations.
- 12.20 For sizing shared open plan administration areas (with six or more workstations) an allowance of 5 m<sup>2</sup> per workstation may be used.
- 12.21 In order to function properly, a series of support spaces are recommended where workstations are provided within open plan areas.
- 12.22 For briefing purposes, open plan offices with eight or more workstations may be sized at 6.6 m<sup>2</sup> per workstation. This allows for the following:
- space for the workstation;
  - one interview room (4 places) for every 16 workstations;
  - one quiet workspace for every 16 workstations (not included within base standard if eight or fewer workstations);
  - one breakout space for every 16 workstations (not included within base standard if eight or fewer workstations);
  - one photocopy/printing room for every 32 workstations.
- 12.23 The allowances include access space within the open plan area but exclude external circulation space.
- 12.24 The allowance of 6.6 m<sup>2</sup> is the average figure from the calculations below.
- 12.25 Open-plan areas with their associated support spaces have similar net space requirements per workstation to 2-person offices. However, open plan areas are considered more flexible and have lower circulation requirements.

Figure 110 Admin area: shared use: 8 workstations



**Table 4 Open-plan office sizes**

<b>Open-plan office space: 8 workstations</b>				
<b>Component spaces</b>	<b>Qty</b>	<b>Unit area allowance</b>	<b>Total area</b>	<b>Open-plan office allowance</b>
Dedicated workstations	8	5.0	40.0	
Photocopy/printing room	1	6.0	6.0	
Breakout space	0	6.0	0.0	
Quiet workspace	0	5.5	0.0	
Interview room	1	8.0	8.0	
<b>Net allowance</b>			<b>54.0</b>	<b>6.8 per workstation</b>
<b>Open-plan office space: 64 dedicated workstations</b>				
<b>Component spaces</b>	<b>Qty</b>	<b>Unit area allowance</b>	<b>Total area</b>	<b>Open-plan office allowance</b>
Dedicated workstations	64	5.0	320.0	
Photocopy/printing room	2	6.0	12.0	
Breakout space	4	6.0	24.0	
Quiet workspace	4	5.5	22.0	
Interview room	4	8.0	32.0	
<b>Net allowance</b>			<b>410.0</b>	<b>6.4 per workstation</b>
<b>Open-plan office space: 8 shared workstations (32 staff)</b>				
<b>Component spaces</b>	<b>Qty</b>	<b>Unit area allowance</b>	<b>Total area</b>	<b>Open-plan office allowance</b>
Shared workstations	8	5.0	40.0	
Photocopy/printing room	1	6.0	6.0	
Breakout space	0	6.0	0.0	
Quiet workspace	0	5.5	0.0	
Interview room	1	8.0	8.0	
<b>Net allowance</b>			<b>54.0</b>	<b>6.8 per workstation</b>
<b>Open-plan office space: 60 shared workstations (240 staff)</b>				
<b>Component spaces</b>	<b>Qty</b>	<b>Unit area allowance</b>	<b>Total area</b>	<b>Open-plan office allowance</b>
Shared workstations	60	5.0	300.0	
Photocopy/printing room	2	6.0	12.0	
Breakout space	4	6.0	24.0	
Quiet workspace	4	5.5	22.0	
Interview room	4	8.0	32.0	
<b>Net allowance</b>			<b>390.0</b>	<b>6.5 per workstation</b>

**Ergonomic drawings**

*Administration workstation*

12.26 This ergonomic drawing (see Figure 111) shows the space requirements for an administration workstation.

12.27 Office furniture should comply with BS EN 1335-1.

12.28 Desks should include wire management and equipment should be able to be plugged in at desk height. Task lighting should be considered.

12.29 The 900 mm space required to withdraw a chair from the desk will increase to 1000 mm for heavy upholstered chairs.

12.30 Where there is frequent passing behind a desk, the preferred 1500 mm space should be provided. This will also allow for wheelchair access.

Figure 111 Space requirements for an administration workstation

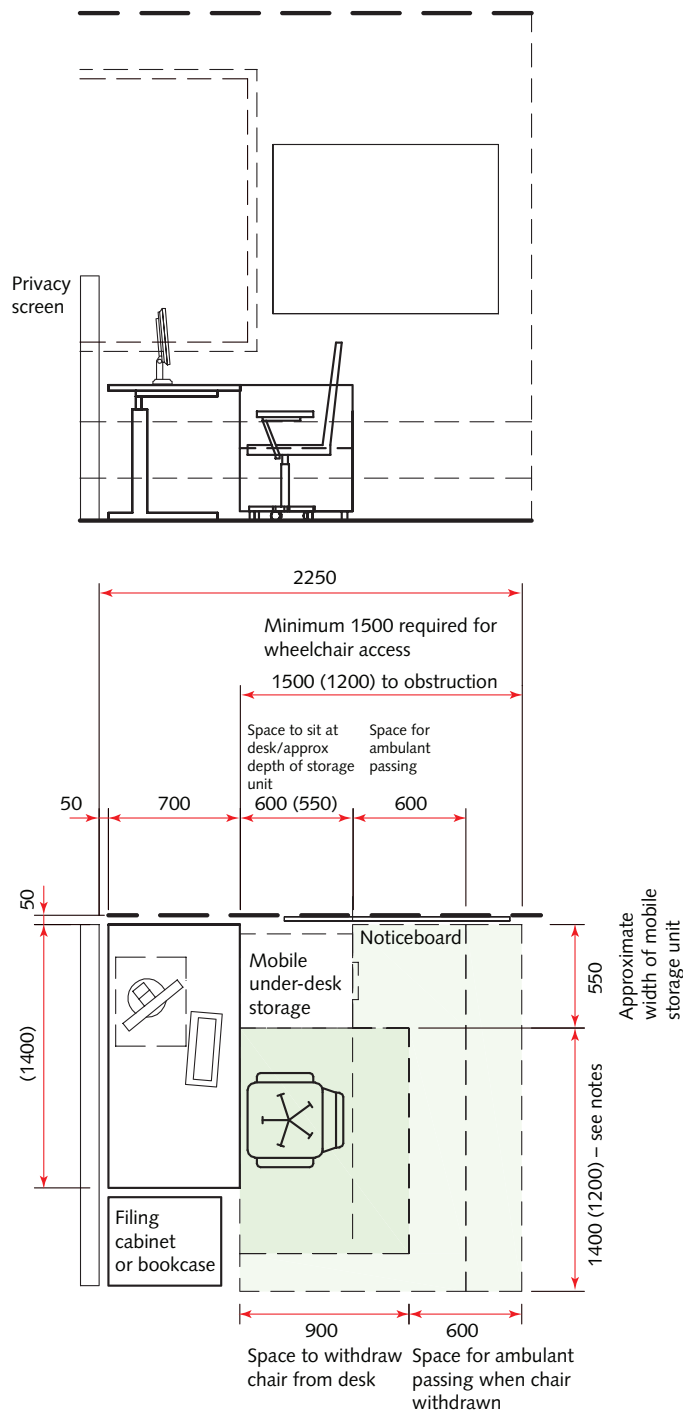



## Breakout space

### Room description and layout

12.31 Breakout spaces are intended to provide for ad hoc social interaction and/or discussions and may be used in either administration areas for staff or within clinical areas for patients or staff.

12.32 The choice of furniture will depend upon the location and function of the space (for example within staff admin areas, chairs and a table for basic work functions, for patient use, easy chairs and a coffee table).

12.33 In open-plan admin areas, they provide extra capacity for workspace should all the shared workstations be occupied. Consideration should be given to providing power and data sockets/outlets for a laptop and a telephone point.

12.34 The room layout provided (see Figure 112) shows a breakout space for use within an administration area.

12.35 Breakout spaces may be located alongside the shared workstations they serve (as shown) or combined with other breakout spaces into a central resource for more flexibility in use.

Figure 112 Space requirements for a breakout space within an administration area

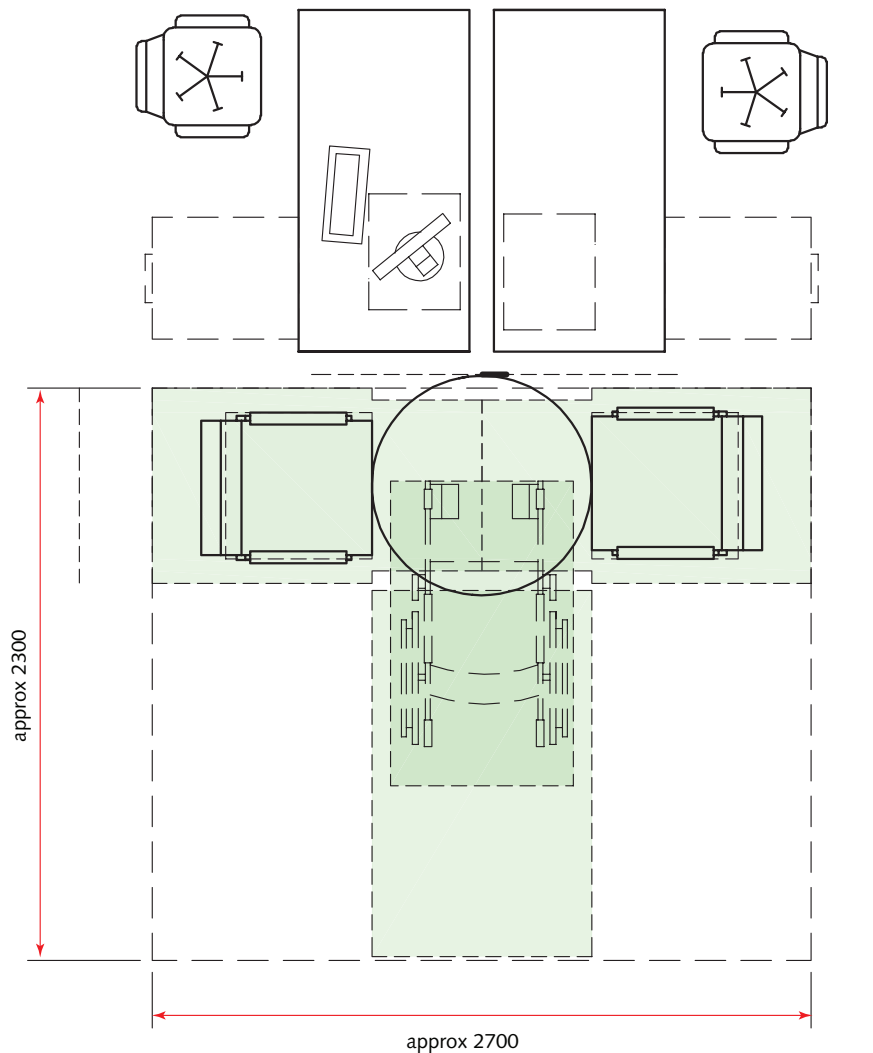

**Ergonomic drawings**

*Space to sit on an easy chair*

12.36 These ergonomic drawings (see Figure 113) show the space requirements for a person to sit on an easy chair.

12.37 When seats are pushed together in rows, the average seat width is 600–650 mm for seats without arms and 750 mm for seats with arms.

Figure 113 Space requirements to sit on an easy chair

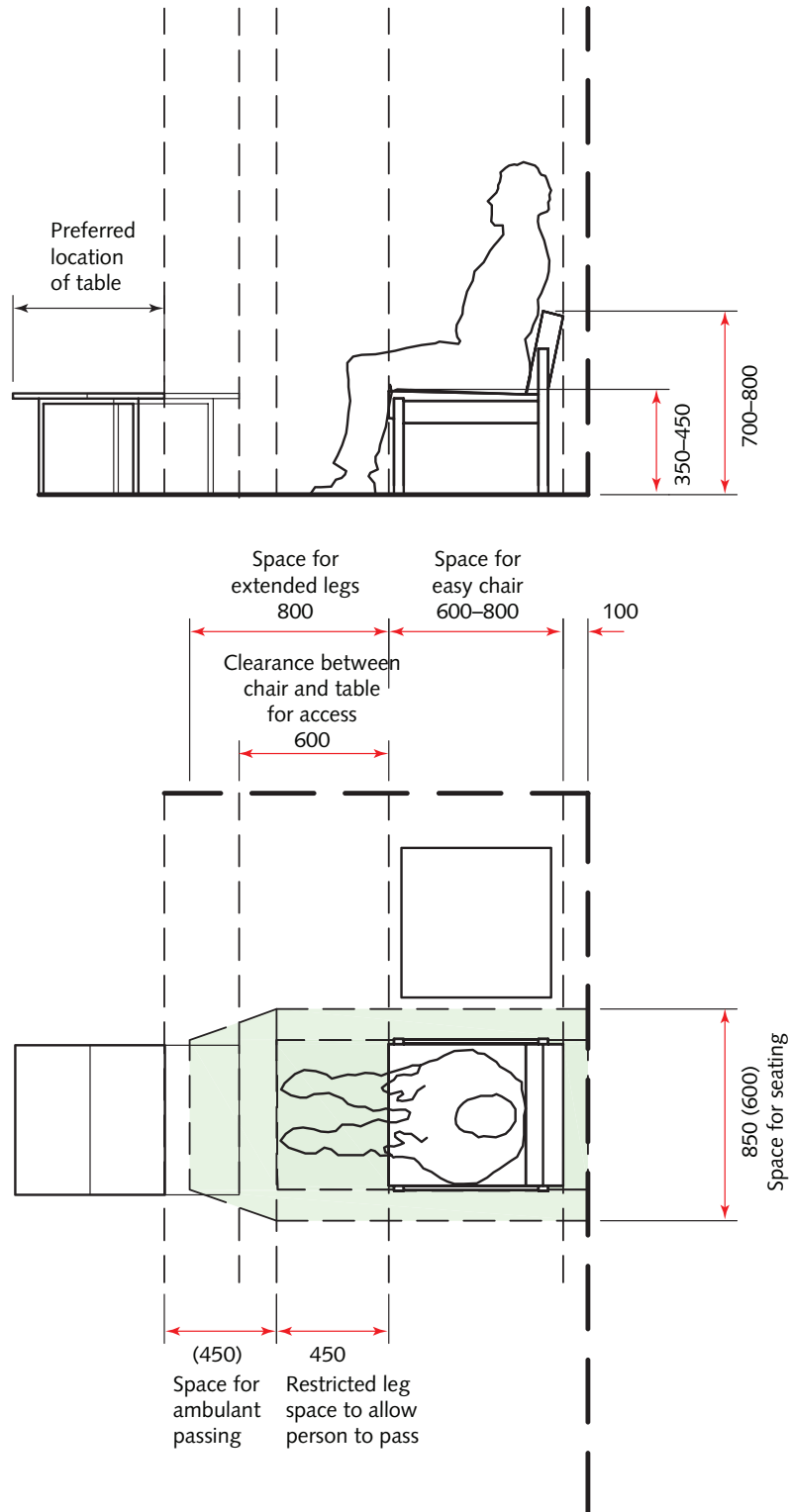

*Working at a desk/table*

12.38 This ergonomic drawing (see Figure 114) illustrates the space requirements for working at a desk/table.

12.39 The chair shown is a standard stacking chair. Where larger chairs are used, the space should be increased by an additional 100 mm in each direction.

12.40 The space requirement for a wheelchair user is based on a standard wheelchair.

12.41 The working zone on the desk/table is 700 mm wide by 500 mm deep. This may be compromised if two users sit at 90 degrees to one another at the corner of the desk/table.

Figure 114 Space requirements for working at a desk/table

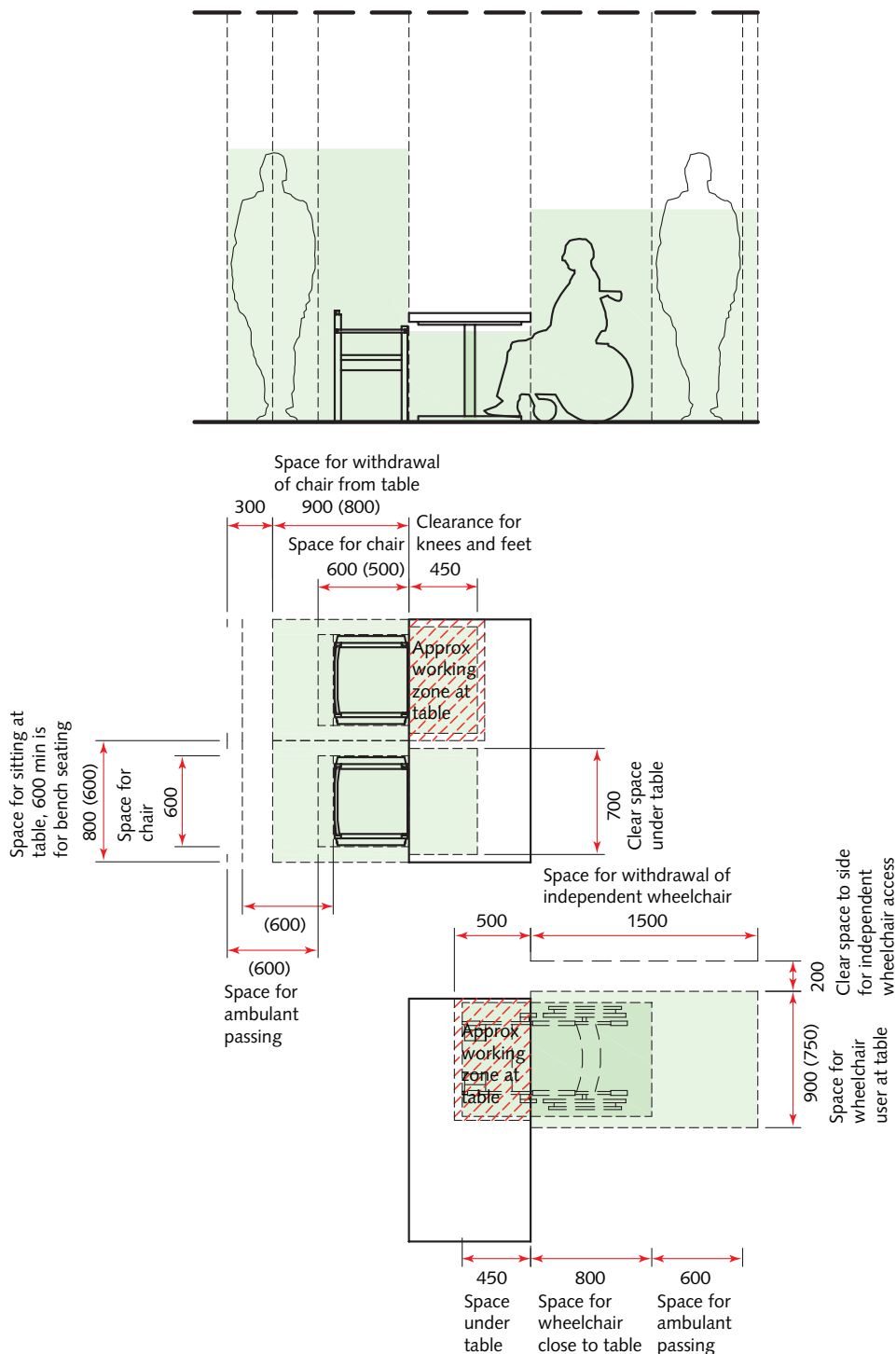

## Quiet workspace

### Room description and layout

12.42 This room provides a quiet space for confidential telephone conversations or laptop/desktopwork by a single person.

12.43 The room has been sized to discourage users from feeling too comfortable and wishing to monopolise the space.

12.44 The design (including finishes) – see Figure 115 – should ensure privacy and a quiet environment.

12.45 It should contain power, data and telephone services.

Figure 115 Space requirements for quiet workspace ensuring privacy

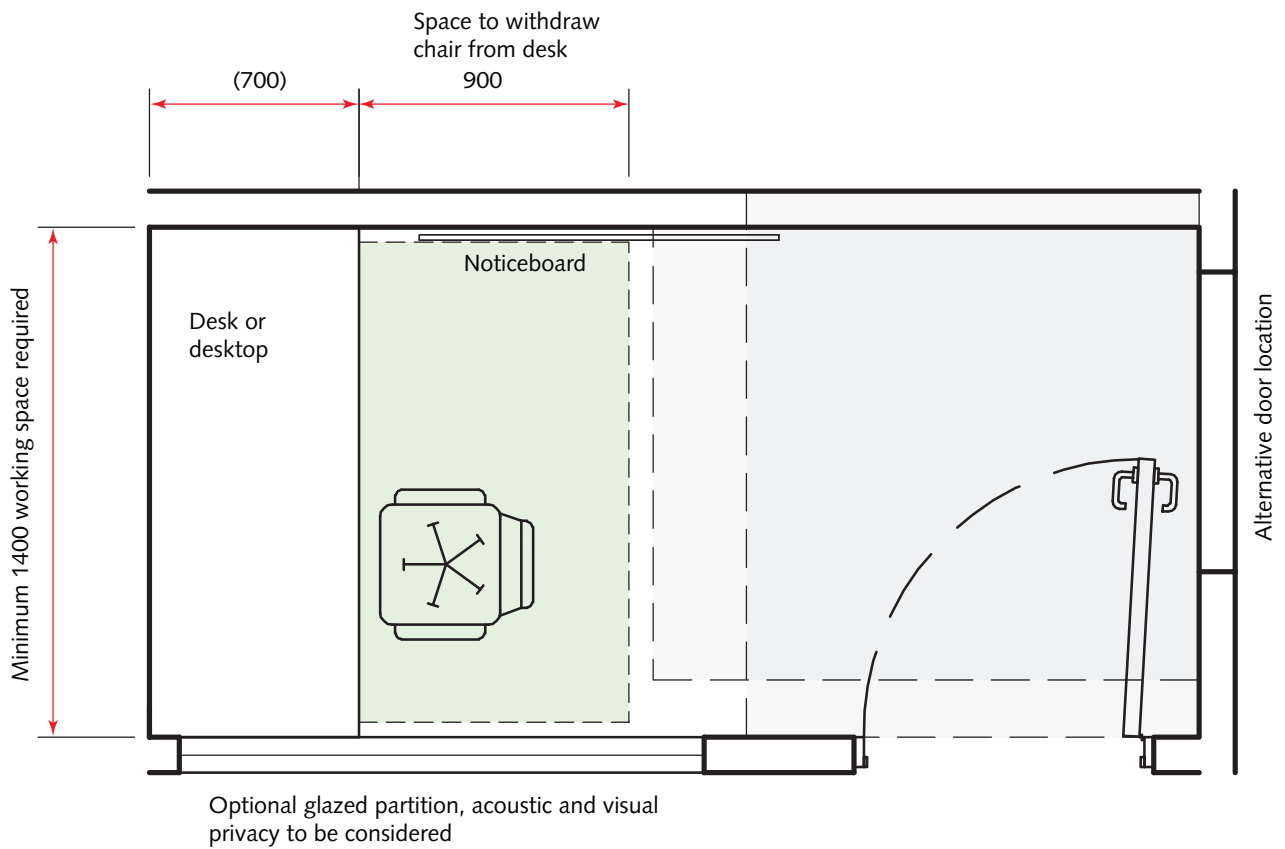

## Staff communication base

### Room description and layout

- 12.46 A staff communication base is a workstation, typically with a split-level counter, intended as a clinical management base within a clinical area.
- 12.47 It replaces the “nurses base” from previous guidance; changes in working practices means the base will be used by a multidisciplinary team rather than just nurses.
- 12.48 It should provide good observation of the clinical area served. Staff emergency call facilities should be provided at the desk.
- 12.49 A telephone and computer should be provided. Task lighting should be considered.
- 12.50 Lamp repeat calls for controlled drugs cupboards (if used) will be located here. An alarm panel may be provided.
- 12.51 Access to a safe room/space must be provided behind the base to ensure staff safety. This could be access to a safe corridor.
- 12.52 A local printer and fax machine may be located in a room behind the base or other nearby secure area.
- 12.53 A space for private discussions should be provided nearby. This may form a discrete part of the base with glass screens or an interview room may be provided for this purpose.
- 12.54 The number of workstations should be based on maximum staff usage at any one time.
- 12.55 Space around the base should ensure free movement of traffic when someone is standing in front of the base.
- 12.56 The layout provided (see [Figure 116](#)) illustrates the generic design issues and space requirements for a staff communication base. Actual design requirements will depend upon local requirements.
- 12.57 The main issues to consider when evaluating the requirements for a staff communication base are:
- the safety of staff at the base and security of the base out-of-hours;
  - the height and size of the desk, which will relate to its access and use.
- 12.58 Staff security may be achieved by providing a vertical or horizontal barrier in front of the base and a safe place behind the base.
- 12.59 The security of the base when not manned/out-of-hours may be achieved by either placing it within a total locked zone of the building or by providing a lockable security grille or similar device to enclose the base.
- 12.60 Care needs to be taken when determining the counter design; high counters can make it difficult for staff and clients to communicate, especially where the client is of short stature, a child, in a wheelchair, or if the client or staff member is hearing impaired. High and particularly wide counters can also create ergonomic risks for staff, particularly short staff.
- 12.61 A low counter is typically around 720 mm above the floor and is suitable for wheelchair/seated users and children. In some circumstances consideration may be given to allowing both the member of staff and client to sit as it may create a more intimate situation.
- 12.62 A high counter, also known as a parcel shelf, may be provided to shield equipment etc from outside view, to provide a convenient writing surface for visitors or staff or to provide an additional safety barrier without the use of intimidating safety glass.
- 12.63 A high counter designed for direct interaction between staff and clients should not result in excessive reach across the work surface. The recommended height of a high counter is around 1200 mm and it should be designed to permit the location of a flat panel monitor on the work surface below (note: BS 8300 recommend a 1100 mm high counter to support standing users).
- 12.64 Staff communication bases with both high and low sections are generally recommended.
- 12.65 The recommended minimum working width for a member of staff at the base is 800 mm per person. A width of 1200 mm per person is generally only required for prolonged use but has been included in the examples for flexibility.
- 12.66 BS 8300 recommends, and Approved Document M requires, that the minimum width of the low level section of counter is 1500 mm, preferably 1800 mm, to allow for a wheelchair user and attendant on one side or two wheelchair users to face each other diagonally.
- 12.67 In addition to staff emergency call, power and data services, the following controls and/or indicators may be located at the base as appropriate:

- controls for general lighting, heating, medical gas isolation and entry systems;
- indicator panels for call systems, fire alarm and controlled drugs cupboards.

12.68 For more details of the space requirements for access to the desk for wheelchair users see BS 8300.

Figure 116 Space requirement for staff communication base

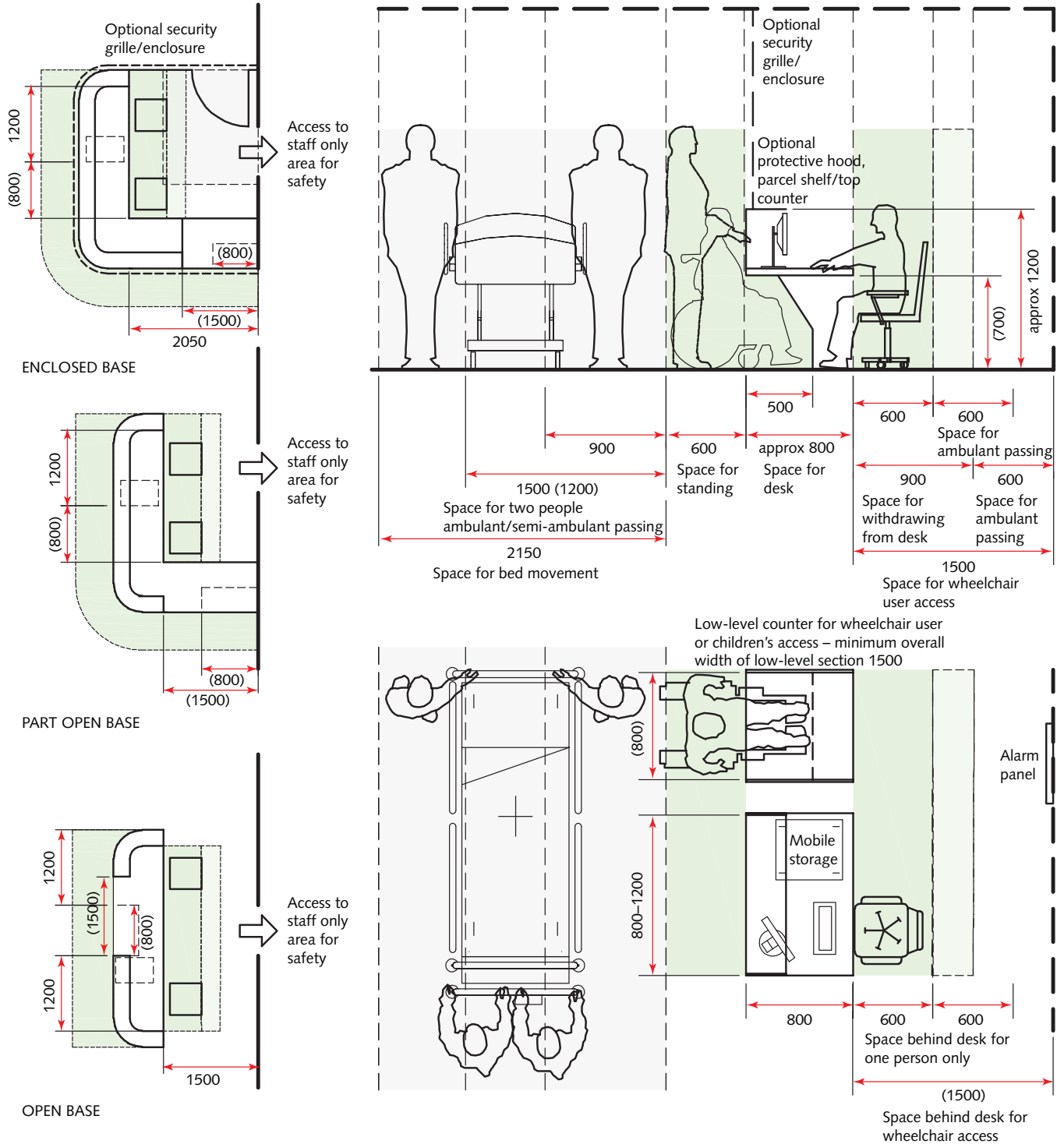

## Touchdown base

### Room description and layout

- 12.69 A touchdown base is intended for accessing and updating electronic patient records and other computer work, adjacent to, but not within, an individual clinical room. It should only be used for short periods of time.
- 12.70 The touchdown base may consist of a worktop (as shown) or mobile workstation and computer at standing height.
- 12.71 A touchdown base should be recessed sufficiently from any circulation routes so that a member of

staff, standing or perching on a stool, does not cause an obstruction.

- 12.72 An alarm panel and lamp repeat calls for controlled drugs cupboards (if used) may be located here.
- 12.73 The computer screen should provide good visibility to the user. Task lighting should be considered.
- 12.74 The security of information should be considered when the computer is not in use/not manned.
- 12.75 The base should include a telephone socket.
- 12.76 The layout provided (see Figure 117) is based on single-person use.

Figure 117 Space requirement for a touchdown base, single-person use

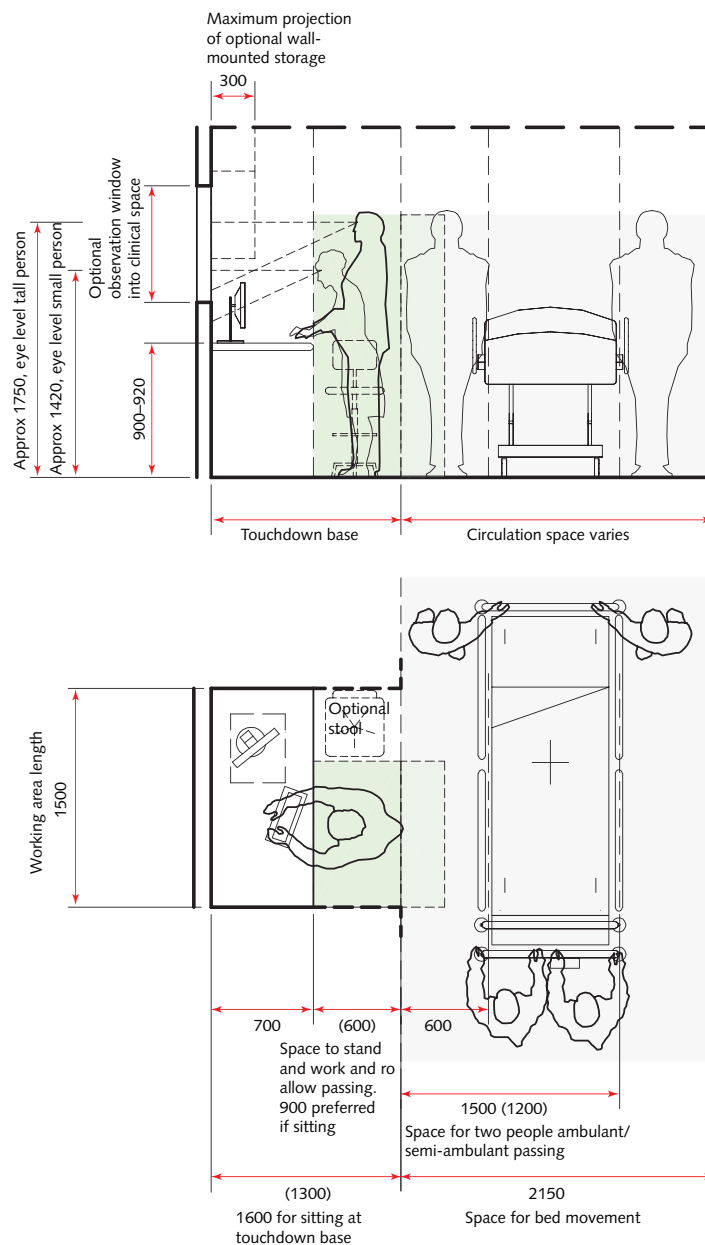

**Ergonomic drawings**

*Clinical workstation*

12.77 This ergonomic drawing (see Figure 118) shows the space requirements for a clinical workstation.

12.78 The clinical workstation is intended for accessing and updating patient records within a clinical environment. It should only be used for short periods of time.

Figure 118 Space requirements for a clinical workstation

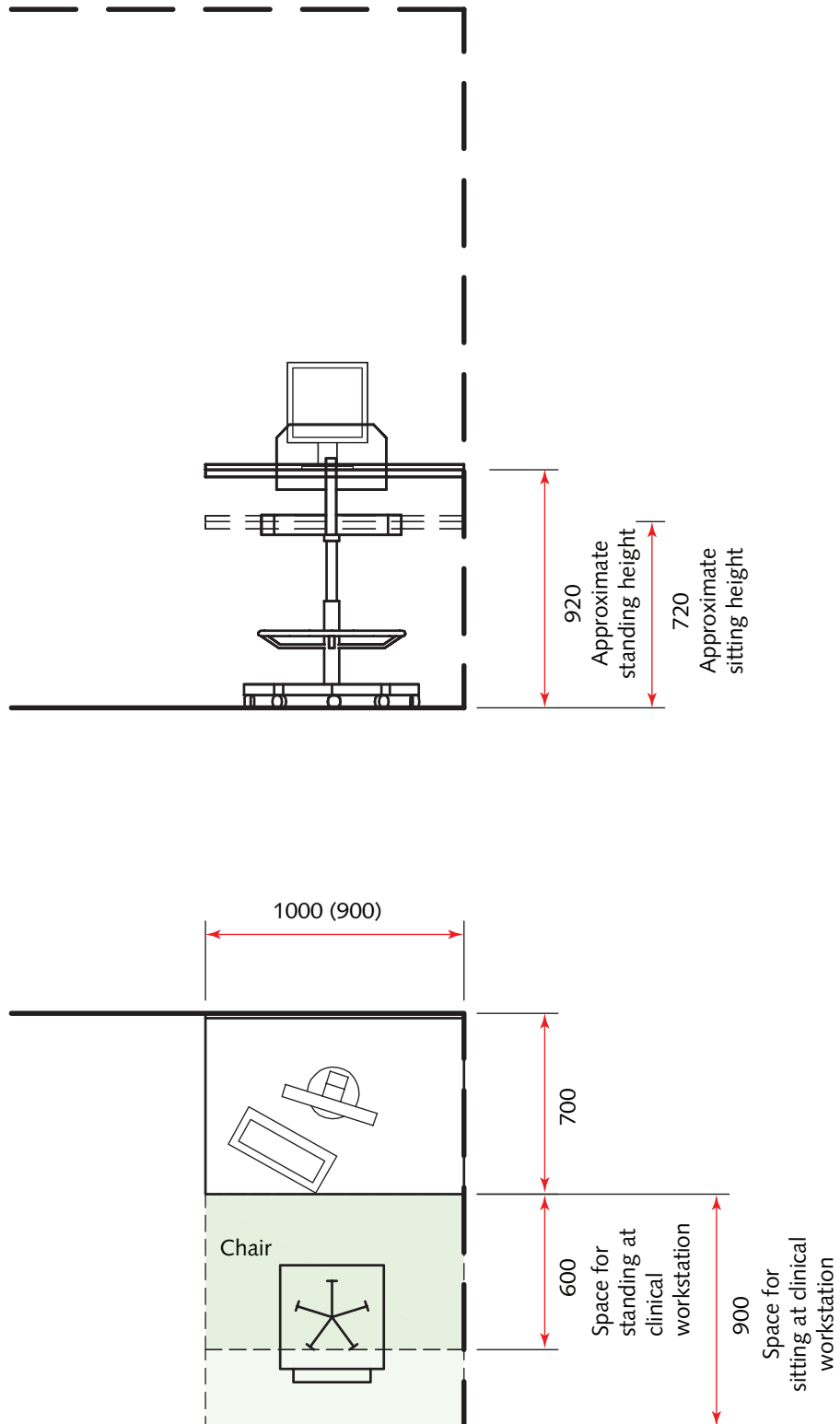



## 13 Generic clinical admin spaces: Offices

### Office/meeting room

#### Room description and layout

13.1 An office/meeting room is intended as a multipurpose office within a clinical environment for handover meetings and technical reviews.

13.2 The room layout provided (see Figure 119) includes two workstations and a table and chairs for informal meetings/handovers in an enclosed office.

13.3 Lamp repeat calls for controlled drug cupboards (if used) and a key cupboard may be located here.

13.4 A small safe, an alarm panel (see ‘Bedhead services’) and cube lockers for the storage of staff personal belongings may also be provided.

13.5 A printer may be provided in each office if a shared printer is not available nearby. However, consideration must be given to the negative sustainability issues relating to the provision of many small local printers.

Figure 119 Space requirements for enclosed office, two workstations, table and chairs

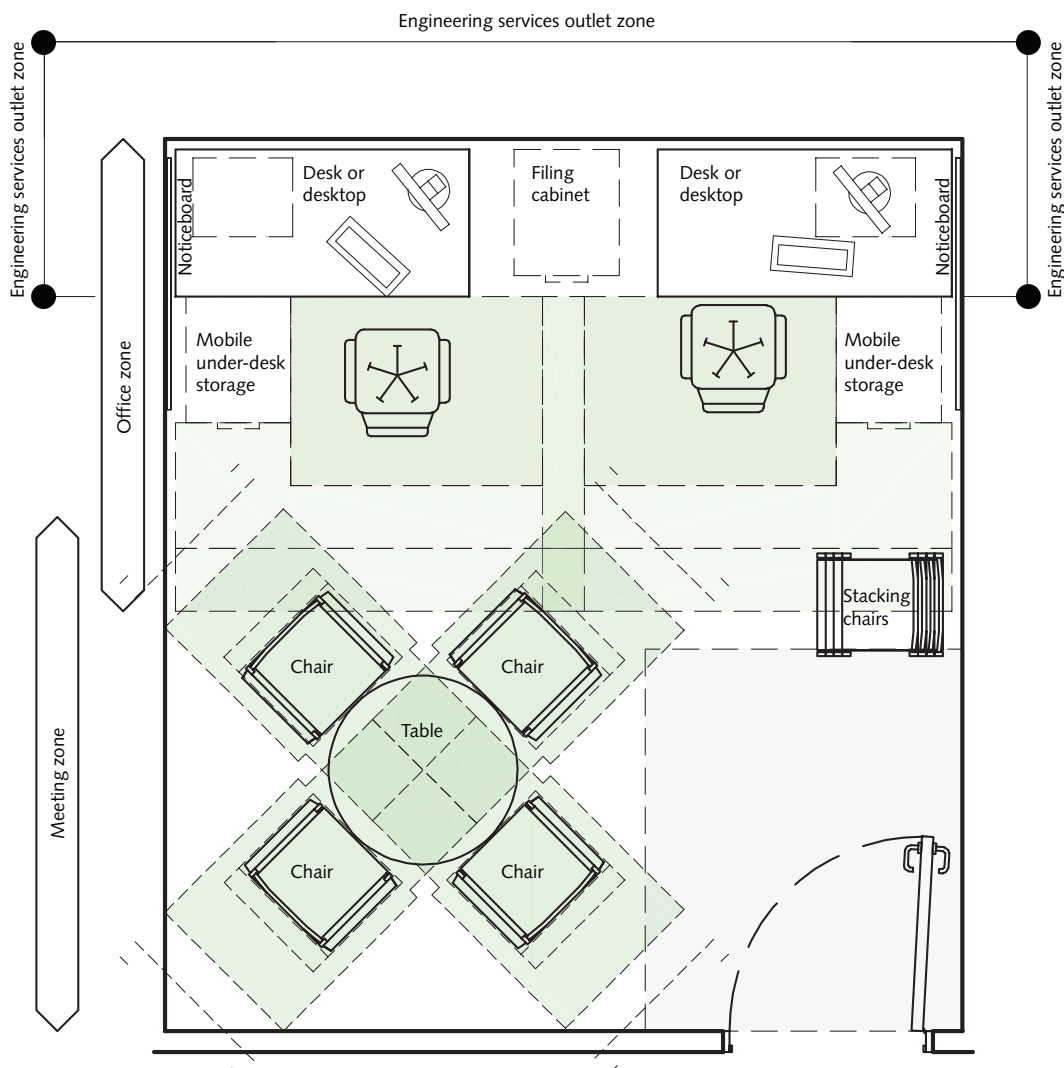

**Ergonomic drawings**

*Administration workstation*

13.6 This ergonomic drawing (see Figure 120) shows the space requirements for an administration workstation.

13.7 Office furniture should comply with BS EN 1335-1.

13.8 Desks should include wire management and equipment should be able to be plugged in at desk height. Task lighting should be considered.

13.9 The 900 mm space required to withdraw a chair from the desk will increase to 1000 mm for heavy upholstered chairs.

13.10 Where there is frequent passing behind a desk, the preferred 1500 mm space should be provided. This will also allow for wheelchair access.

Figure 120 Space requirements for an administration workstation

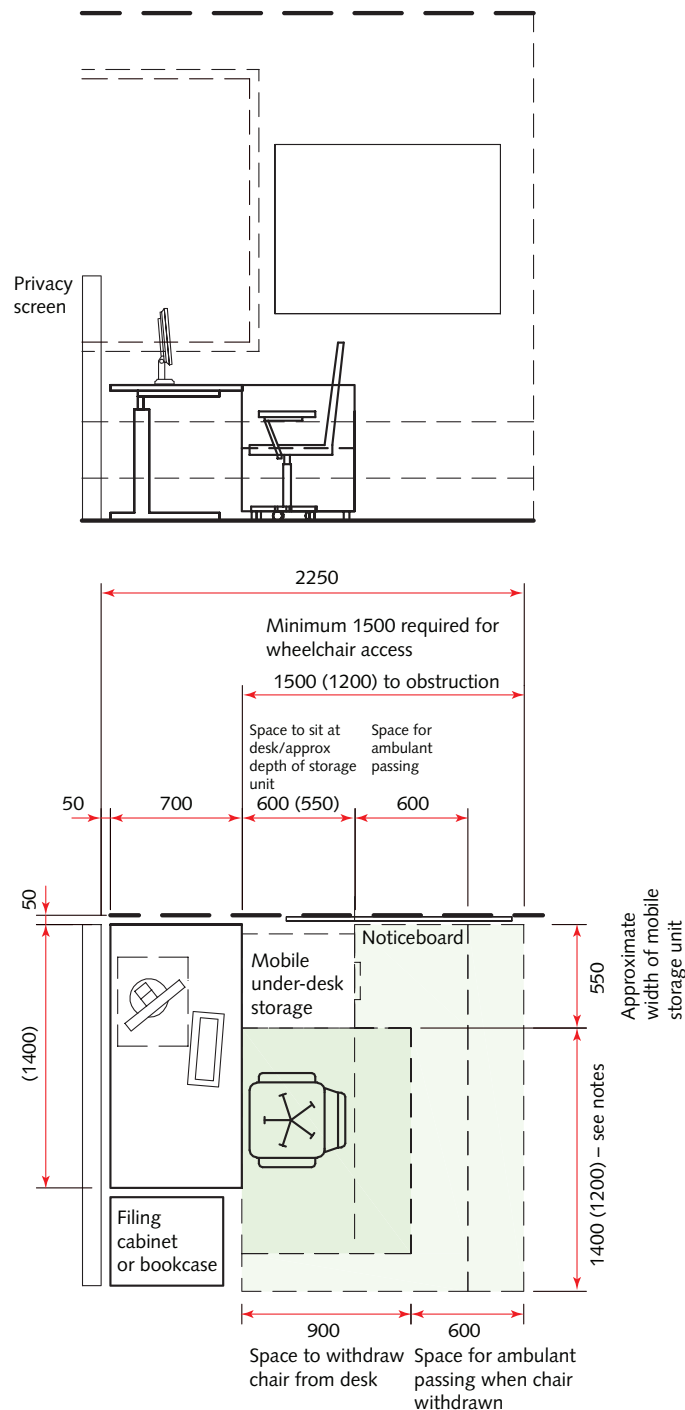

*Working at a desk/table*

- 13.11 This ergonomic drawing (see Figure 121) illustrates the space requirements for working at a desk/table.
- 13.12 The chair shown is a standard stacking chair. Where larger chairs are used, the space should be increased by an additional 100 mm in each direction.

- 13.13 The space requirement for a wheelchair user is based on a standard wheelchair.
- 13.14 The working zone on the desk/table is 700 mm wide by 500 mm deep. This may be compromised if two users sit at 90 degrees to one another at the corner of the desk/table.

Figure 121 Space requirements for working at a desk/table

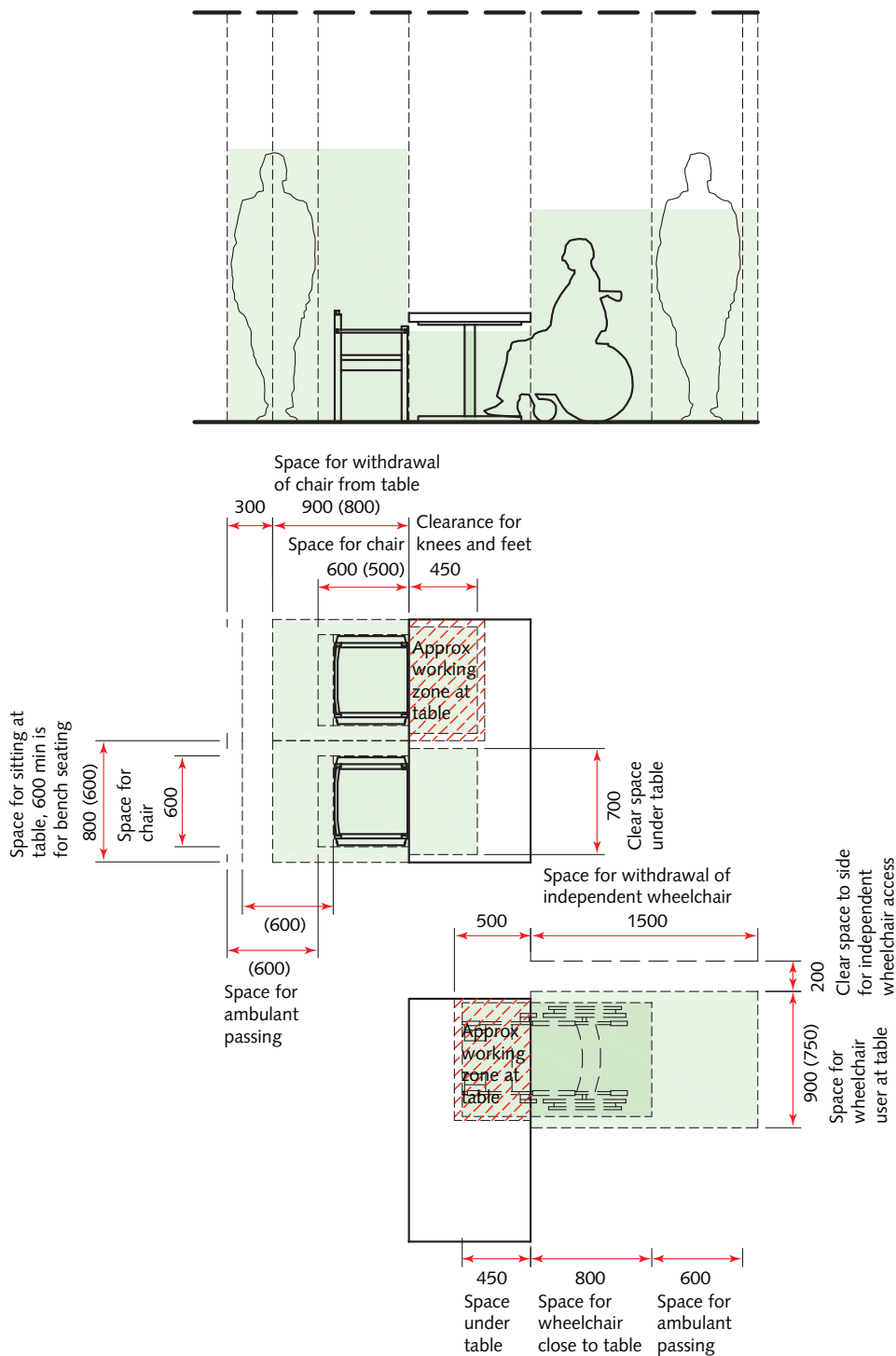

## Office: 1-person

### Room description and layout

- 13.15 Single-person offices (see Figure 122) should only be provided where full-time access to workstations and constant privacy are required.
- 13.16 Offices may be used for discussions and informal interviews as well as clinical administration tasks.

- 13.17 A printer may be provided in each office if a shared printer is not available nearby. However, consideration must be given to the negative sustainability issues relating to the provision of many small local printers.
- 13.18 If the room is used for clinical control, the lamp repeat calls for controlled drugs cupboards (if used) and a key cupboard will be required. A small safe and an alarm panel (see 'Bedhead services') may also be provided.

Figure 122 Space requirements for a single-person office

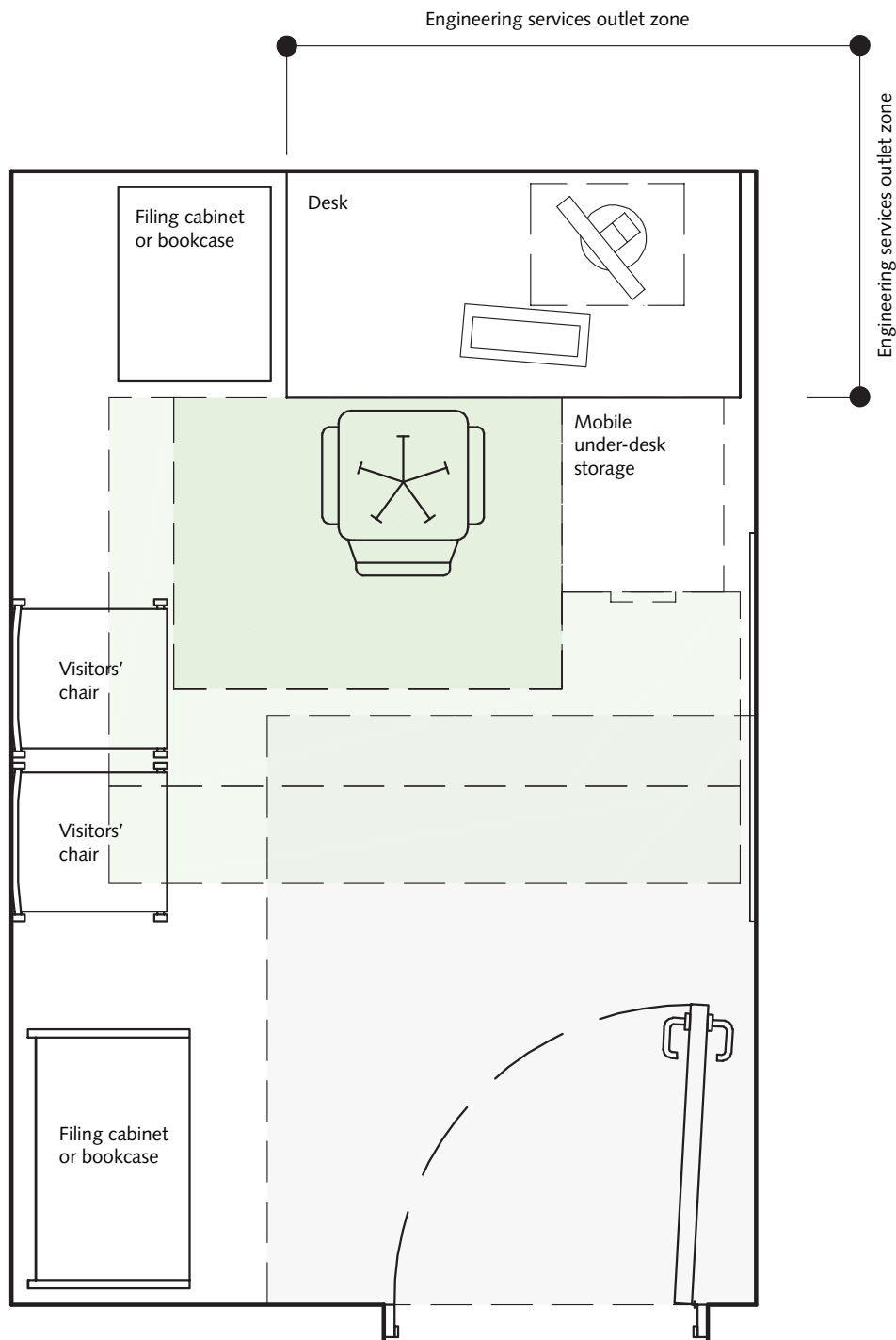

**Ergonomic drawings**

*Administration workstation*

13.19 This ergonomic drawing (see Figure 123) shows the space requirements for an administration workstation.

13.20 Office furniture should comply with BS EN 1335-1.

13.21 Desks should include wire management and equipment should be able to be plugged in at desk height. Task lighting should be considered.

13.22 The 900 mm space required to withdraw a chair from the desk will increase to 1000 mm for heavy upholstered chairs.

13.23 Where there is frequent passing behind a desk, the preferred 1500 mm space should be provided. This will also allow for wheelchair access.

Figure 123 Space requirements for an administration workstation

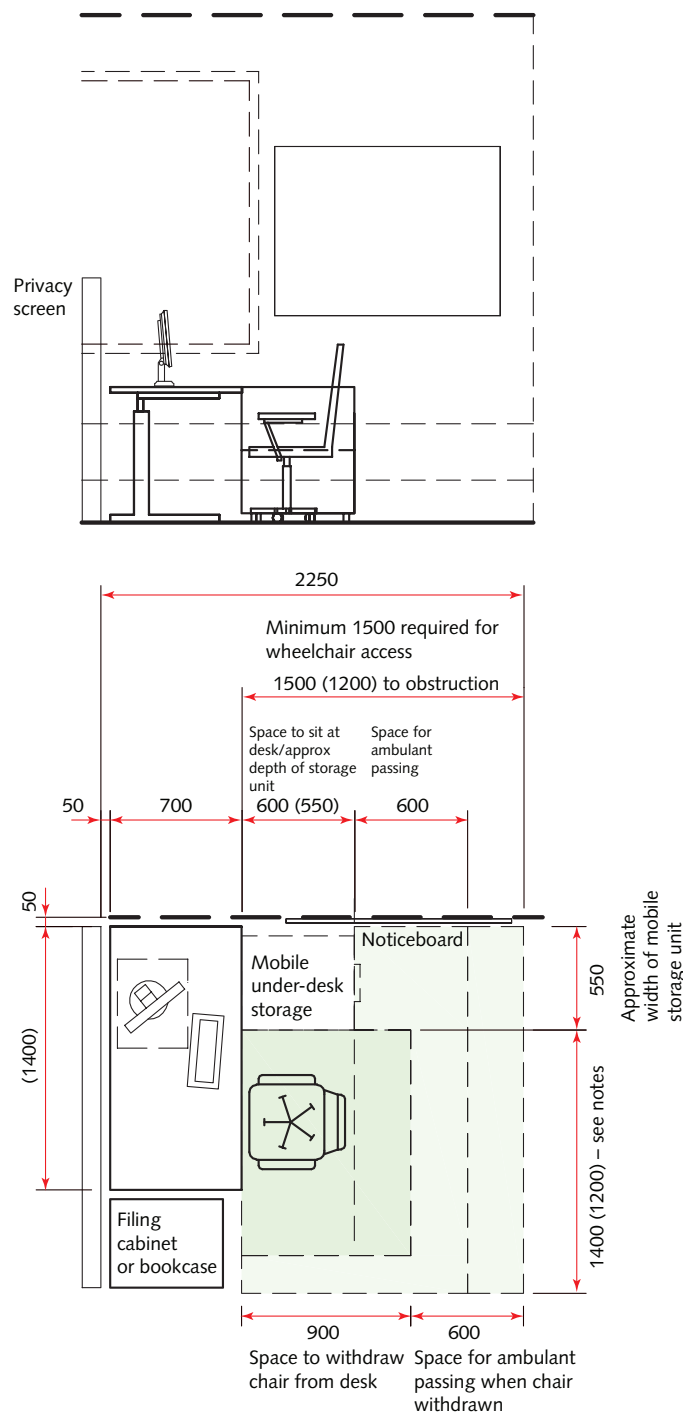

## Office: 2-person

### Room description and layout

13.24 Offices may be used for discussions and informal interviews as well as clinical administration tasks.

13.25 A printer may be provided in each office if a shared printer is not available nearby. However, consideration must be given to the negative sustainability issues relating to the provision of many small local printers.

Figure 124 Space requirements for a two-person office

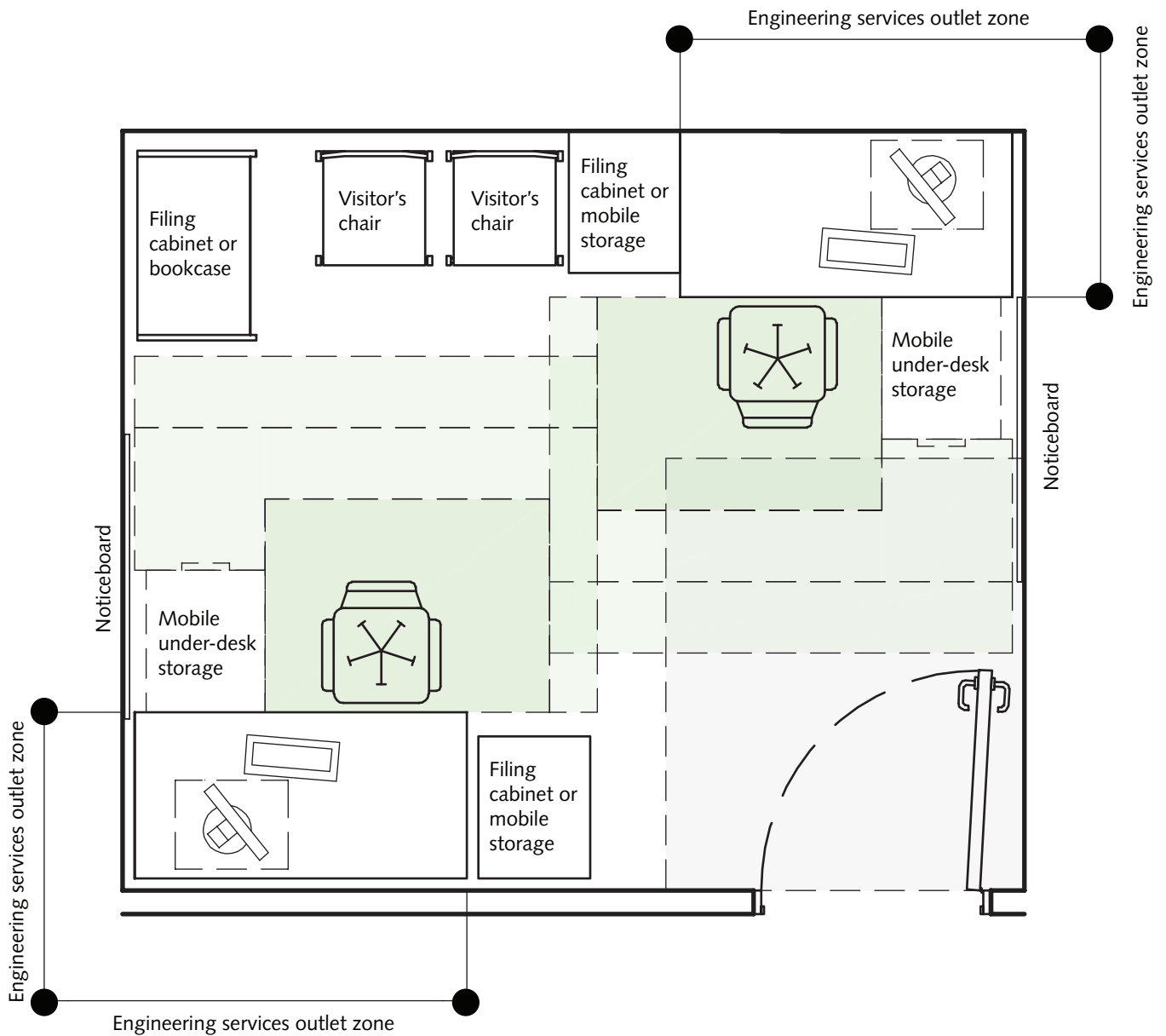

**Ergonomic drawings**

*Administration workstation*

13.26 This ergonomic drawing (see Figure 125) shows the space requirements for an administration workstation.

13.27 Office furniture should comply with BS EN 1335-1.

13.28 Desks should include wire management and equipment should be able to be plugged in at desk height. Task lighting should be considered.

13.29 The 900 mm space required to withdraw a chair from the desk will increase to 1000 mm for heavy upholstered chairs.

13.30 Where there is frequent passing behind a desk, the preferred 1500 mm space should be provided. This will also allow for wheelchair access.

Figure 125 Space requirements for an administration workstation

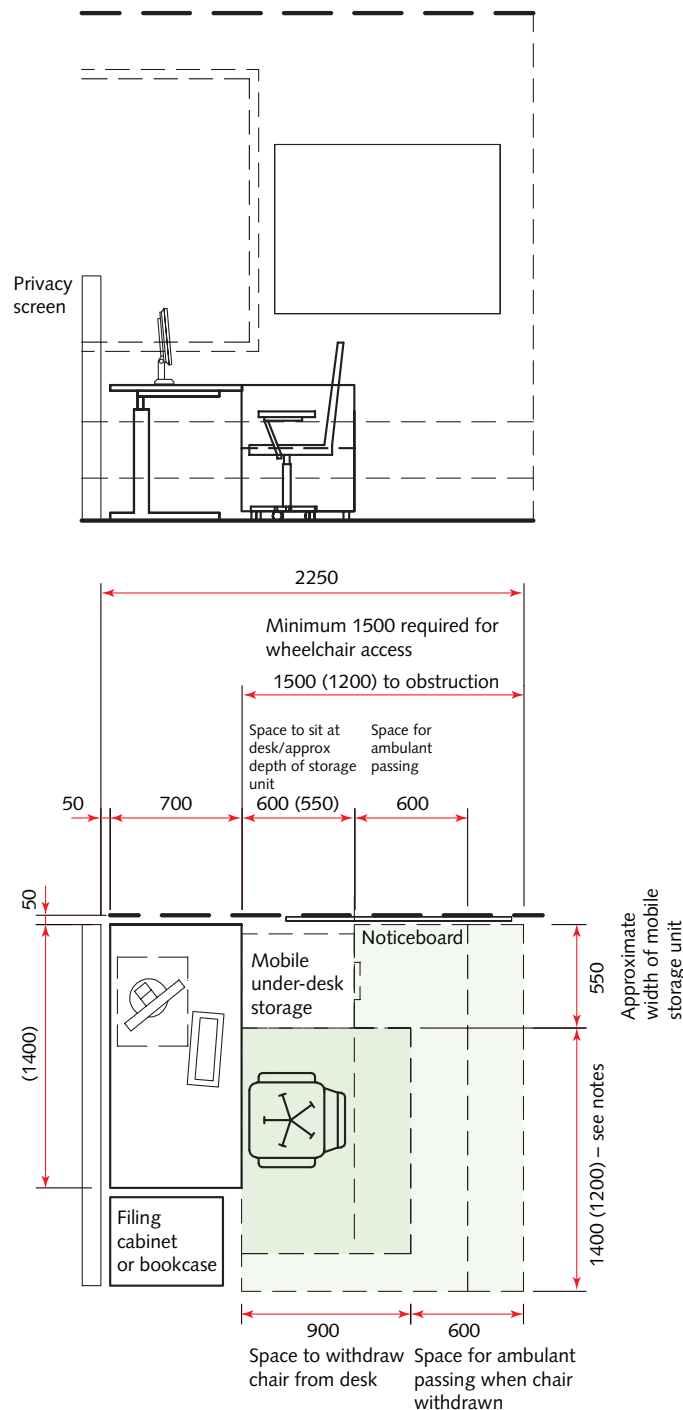

# 14 Specialist spaces

## Plaster room

### Room description and layout

14.1 A plaster room is used for the fitting and removal of plaster casts.

14.2 The room layout provided (see Figure 126) is based on option 2 of the double-sided couch access treatment room with the inclusion of a plaster sink and associated ventilation for plaster dust.

14.3 The computer must be suitable for use in a dusty environment.

Figure 126 Space requirements for a plaster room

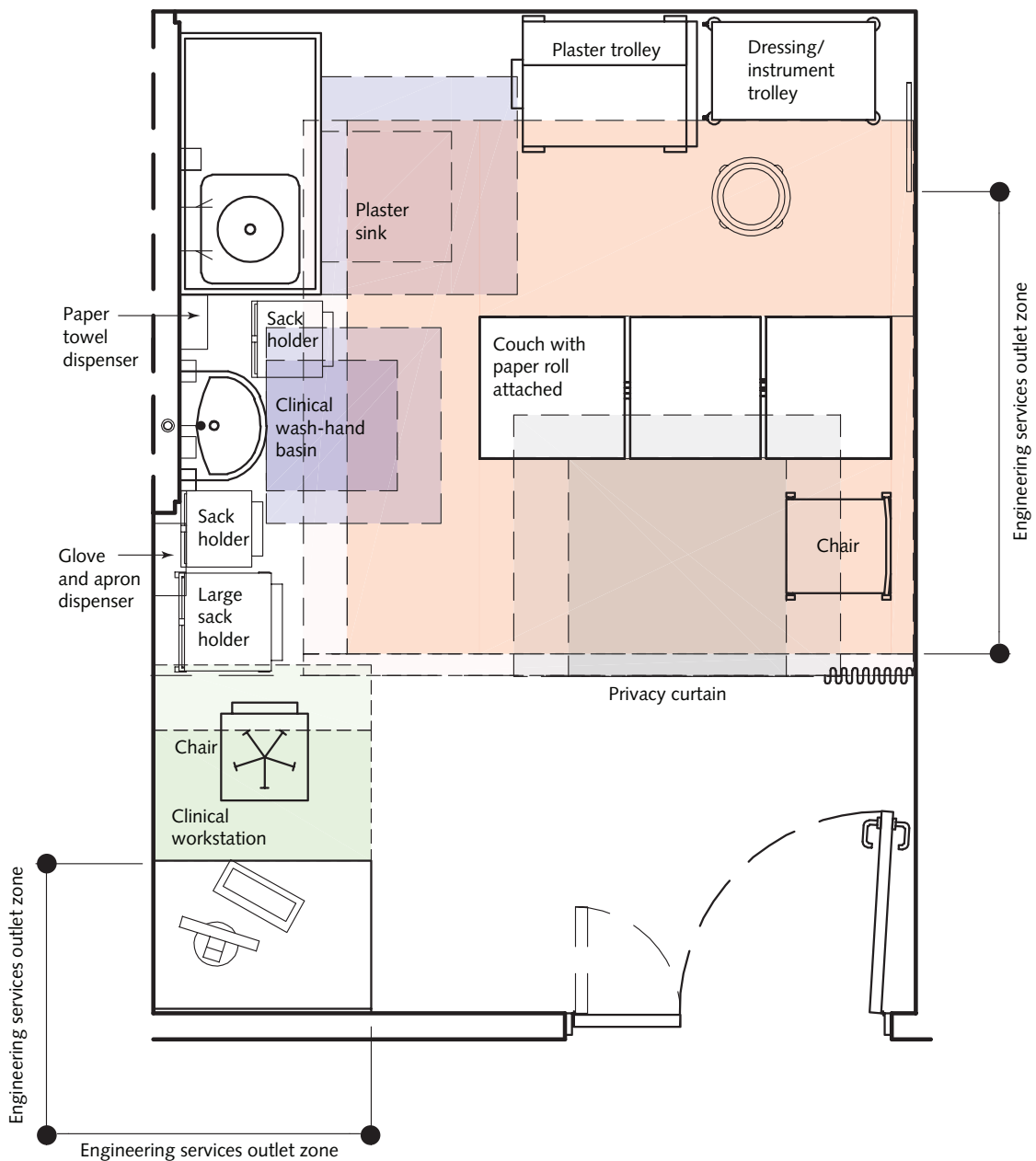



## Ergonomic drawings

### Clinical wash-hand basin

14.4 These ergonomic drawings (see [Figure 127](#)) show the space requirements for standing use of a clinical wash-hand basin assembly. For seated use, the basin will need to be lowered.

14.5 The basin should be fitted with non-touch taps.

14.6 The recommended fixing height of a lever tap on a clinical wash-hand basin is 1095 mm. Where a lever tap is used, the fixing height of the dispensers should be chosen to reduce any possible conflicts in use.

14.7 The illustrated clinical wash-hand basin projects 400 mm from the back panel or wall. However, clinical wash-hand basins may vary from 350 to 500 mm projection. Where basins deeper than 400 mm are used, the impact on/from other components and/or activities undertaken within any space should be considered when evaluating any room layout.

14.8 The glove and apron dispenser illustrated is a combined unit; this is considered the most compact solution although separate units may also be used. Even the most compact unit cannot practically be located within comfortable reach of the basin; it should, however, be conveniently located within the room.

14.9 The ergonomic advice for the height of horizontal elbow operated lever taps is based on the following data:

“Elbow height for shod, slightly bent posture (as when leaning forward) for 50%ile UK male = 1134 mm, for female 1049 mm. 1090 mm is considered the best compromise for an elbow height for both male and female use. The ergonomic advice for the height of a lever tap is 75 mm below elbow height giving a figure height of approx 1015 mm.”

14.10 Lever taps are not illustrated.

14.11 For detailed information on basins, see Health Building Note 00-10 Part C – ‘Sanitary assemblies’.

Figure 127 Space requirements for standing use of a clinical wash-hand basin assembly

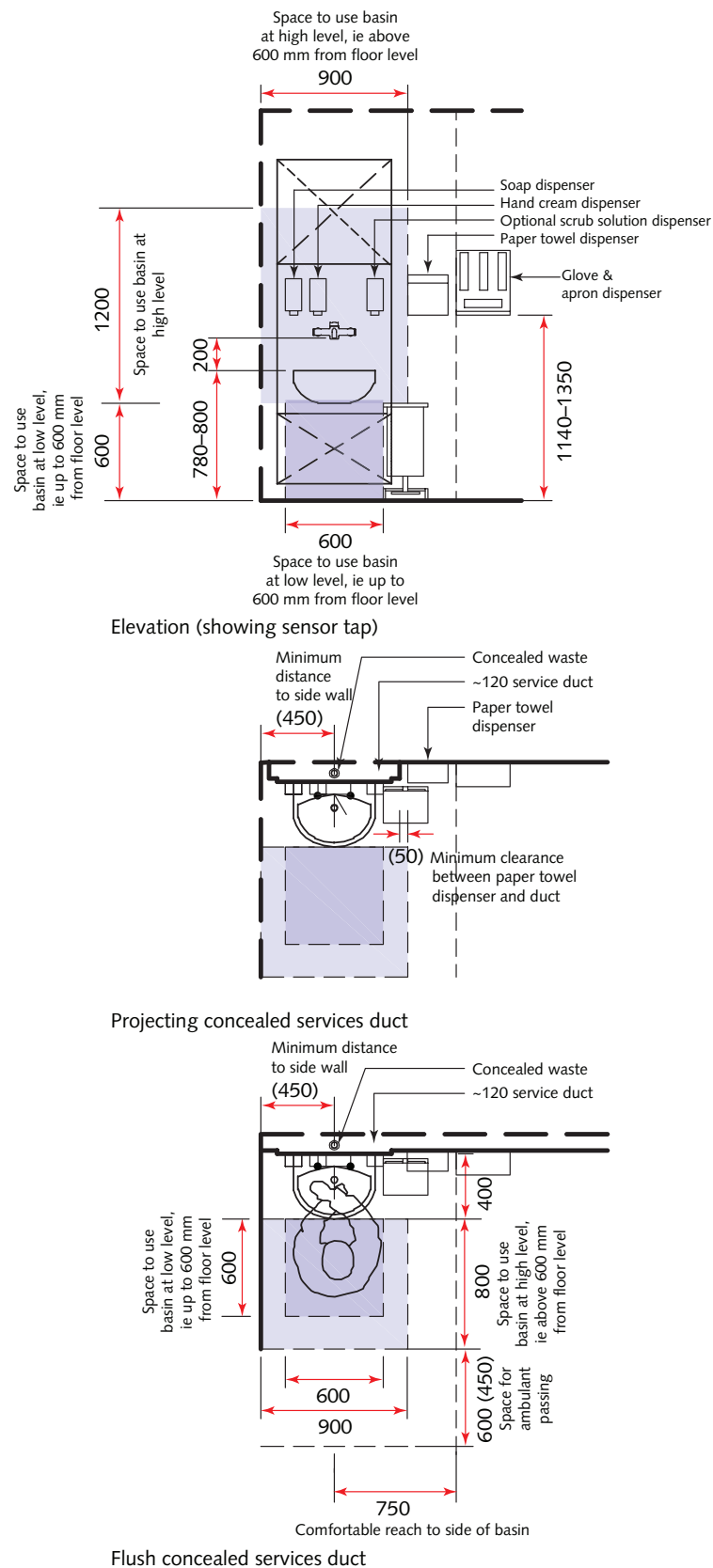

Plaster sink

14.12 This ergonomic drawing (see Figure 128) shows the space requirements for a plaster sink 1200 mm long and 600 mm deep. However, plaster sinks range in length from 1000 mm to 1600 mm. For

further information on plaster sinks, see Health Building Note 00-10 Part C – ‘Sanitary assemblies’. The underside of the sink and area beneath it should be designed for ease of cleaning and to avoid dirt traps.

Figure 128 Space requirements for a plaster sink

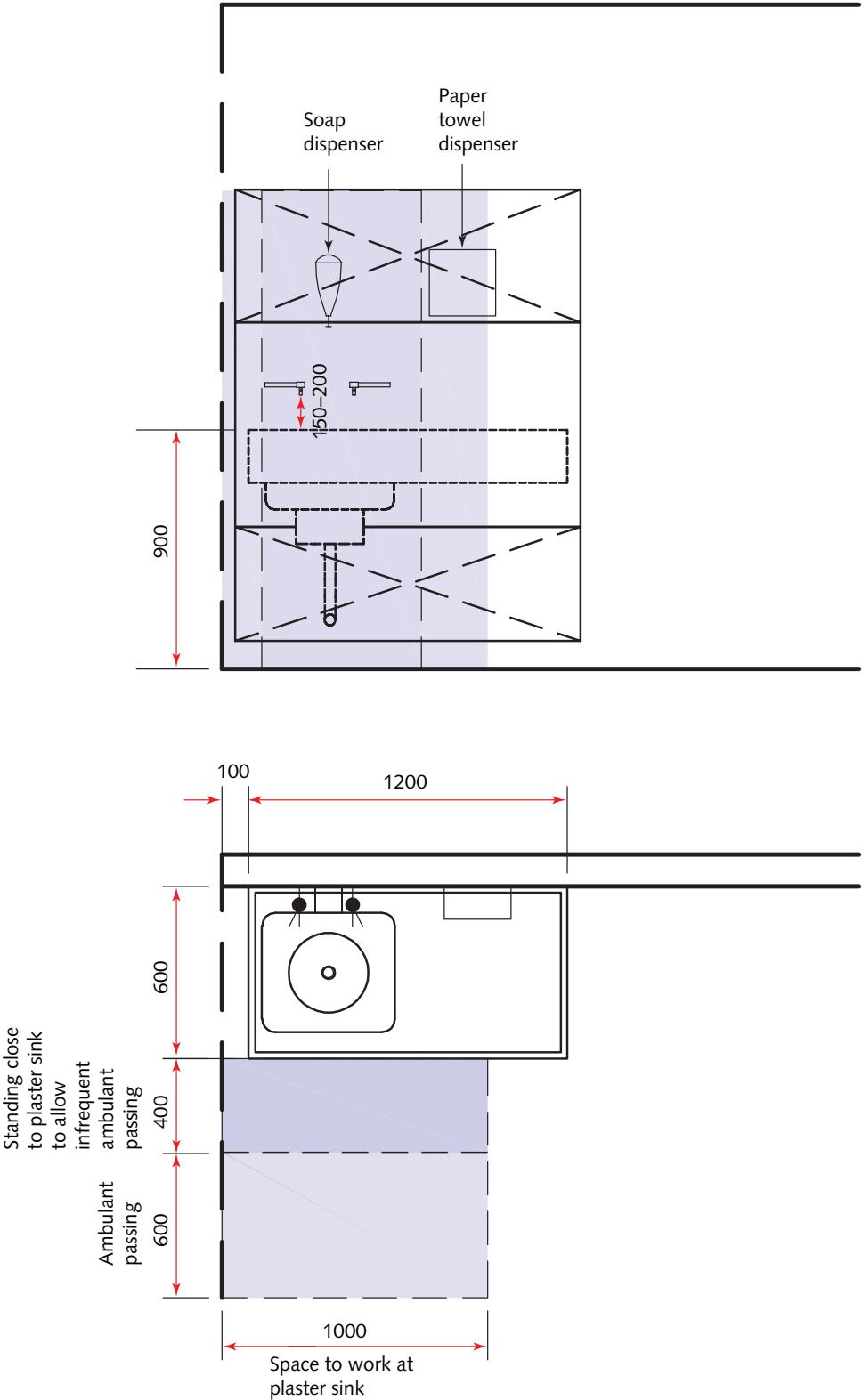

*Clinical workstation*

14.13 This ergonomic drawing (see Figure 129) shows the space requirements for a clinical workstation.

14.14 The clinical workstation is intended for accessing and updating patient records within a clinical environment. It should only be used for short periods of time.

Figure 129 Space requirements for a clinical workstation

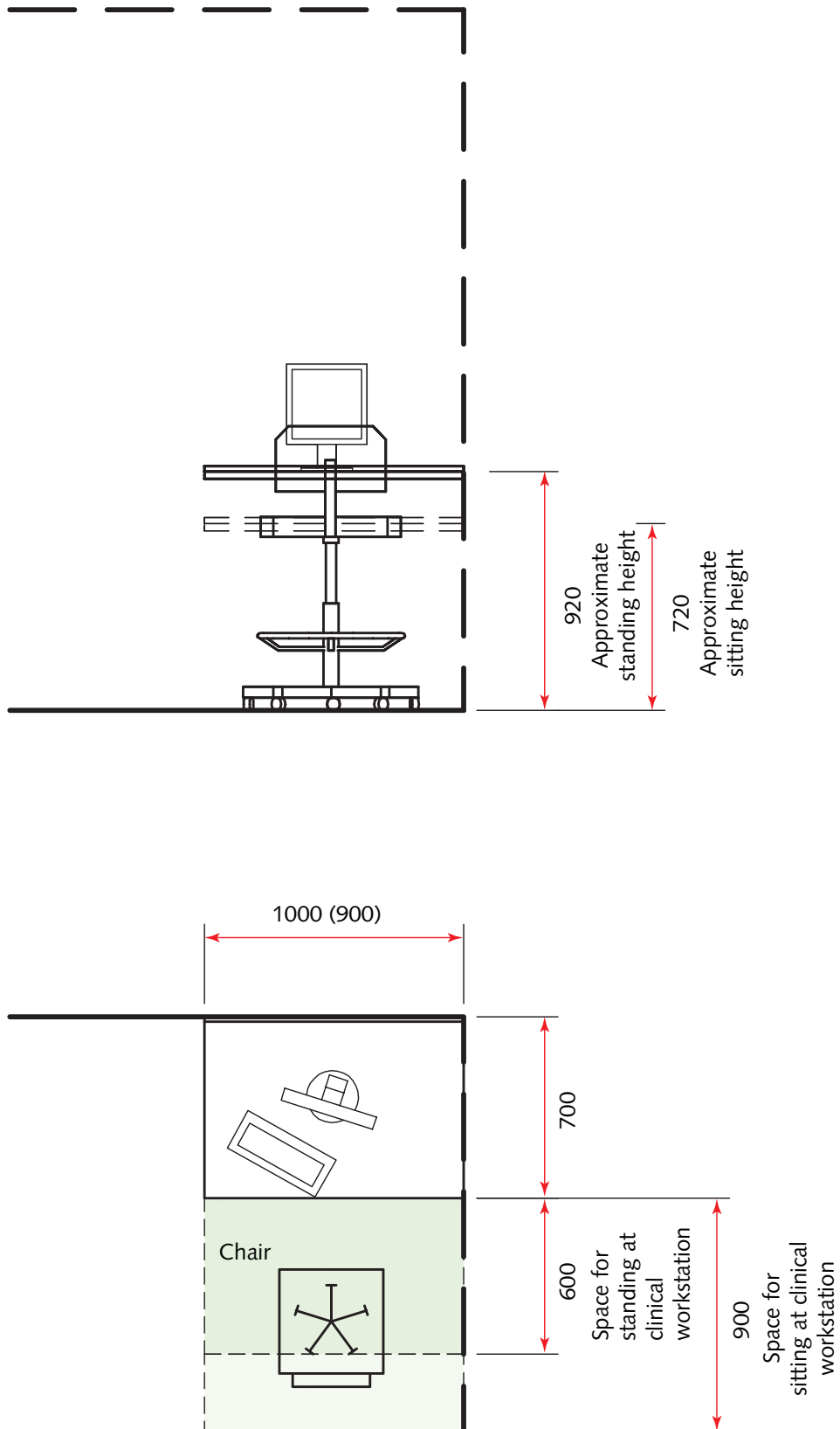

Couch-based plaster activities

14.15 This drawing (see Figure 130) shows the space requirements for double-sided access to a three-section couch for plaster activities.

14.16 The space is slightly larger than that allowed for general examinations or treatments to allow for plastering activities.

14.17 This space has not been defined by specific ergonomic research.

Figure 130 Space requirements for double-sided access to a three-section couch for plaster activities

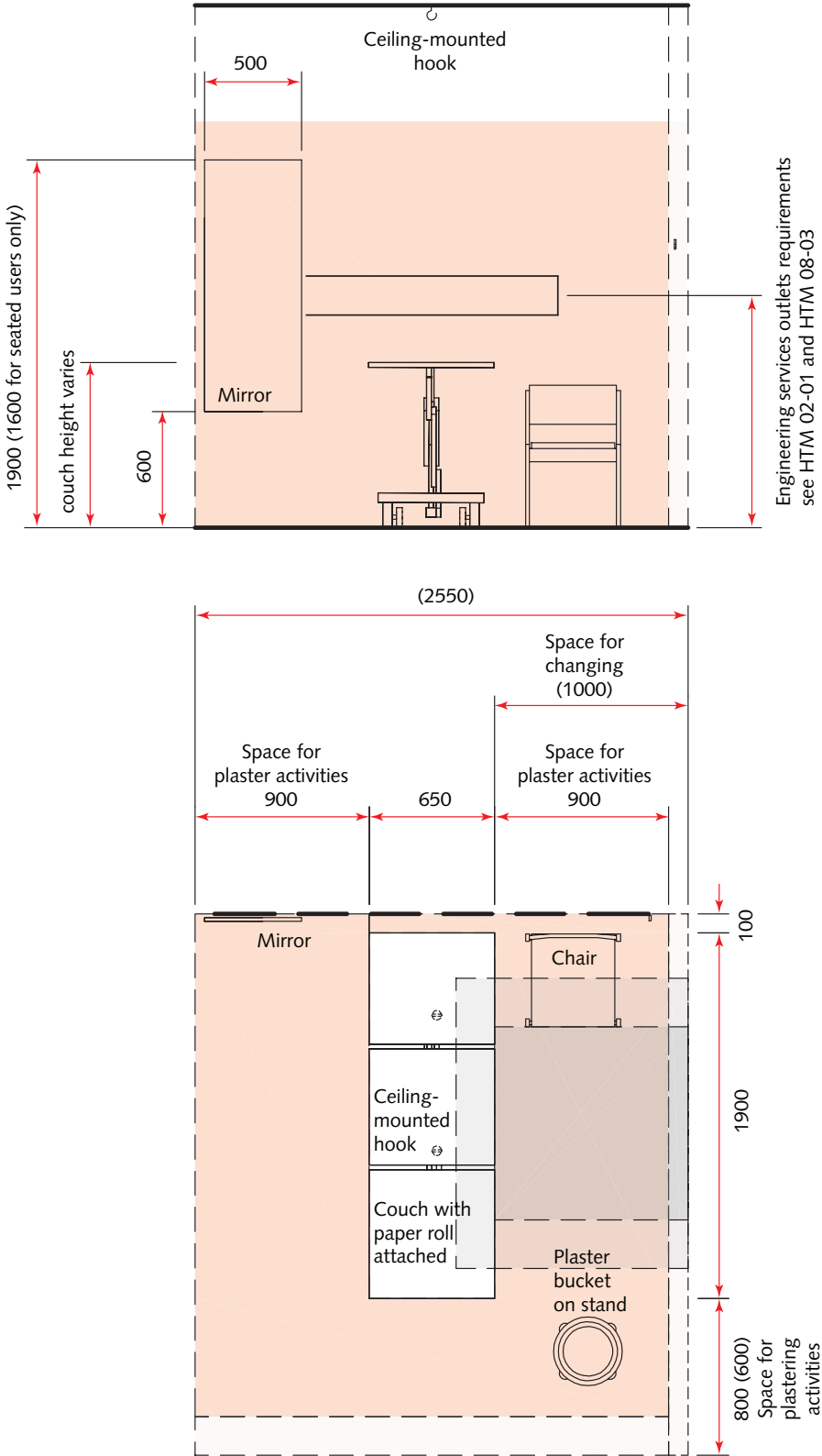

*Dressing and undressing: ambulant*

14.18 These ergonomic drawings (see Figure 131) show the space requirements for ambulant dressing and undressing.

14.19 An identical space provision is suitable for semi-ambulant users though it should be located adjacent to a seating area.

Figure 131 Space requirements for ambulant dressing and undressing

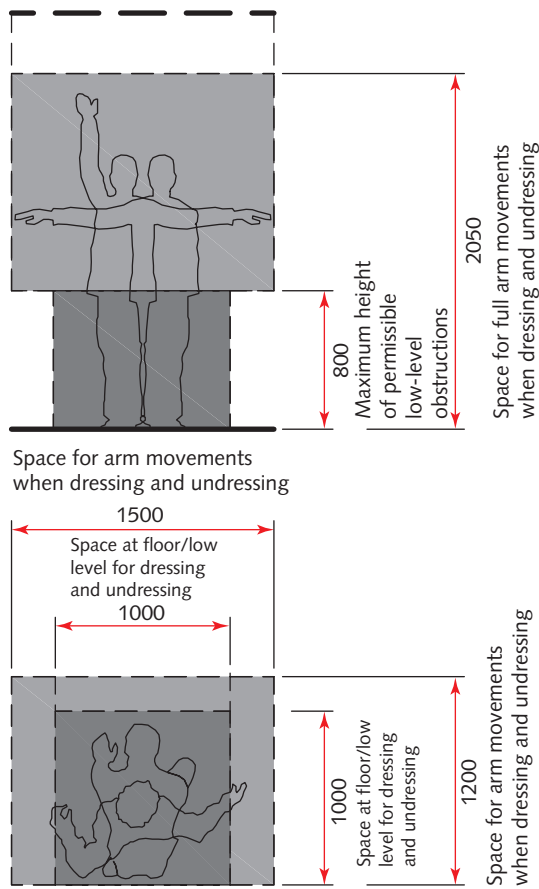

# References

Health Building Note 00-02 – ‘Sanitary spaces’.

Health Building Note 00-10 Part C – ‘Sanitary assemblies’.

Health Technical Memorandum 02-01 – ‘Medical gas pipeline systems’.

Health Technical Memorandum 08-03 – ‘Bedhead services’.

Health Building Note 00-04.

Approved Document M (2010).

BS 8300:2001 (2009).

Loughborough University Healthcare Ergonomics & Patient Safety Unit, DH research report B(05)02, Dec 2007.