

STATUS IN NHSSCOTLAND
BEST PRACTICE GUIDANCE

Health Building Note 6
Volume 2:
Diagnostic imaging:
PACS and specialist imaging

DOH Document Code Part - DOH Document Title and Name

This document must be read in conjunction with current Scottish Government Policy and NHSScotland Guidance, which take precedence. These include publications in both: www.sehd.scot.nhs.uk/ and www.hfs.scot.nhs.uk/publications/.

Specific updates for NHSScotland use:**Chapter No**

Para No.

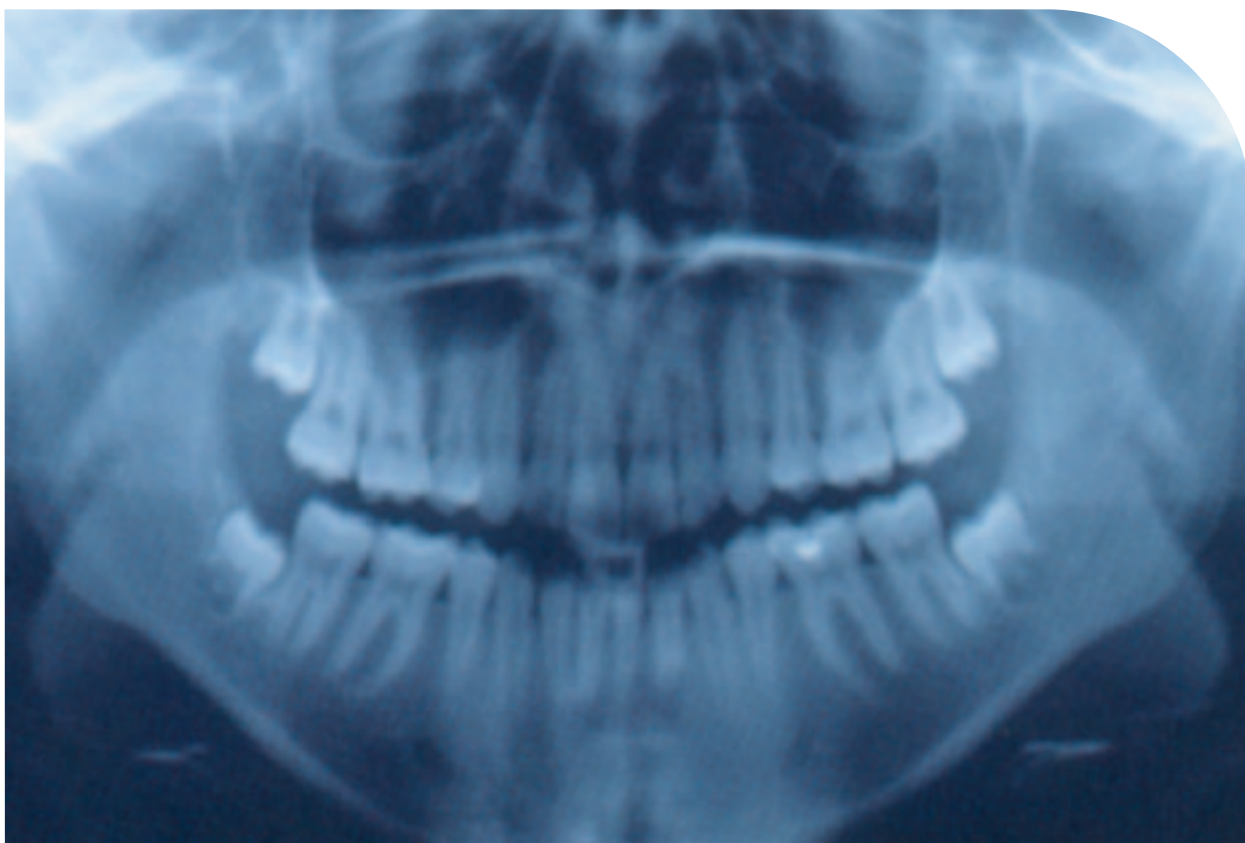

Diagnostic imaging: PACS and specialist imaging

HBN 6 - VOLUME 2

NHS
Estates

Diagnostic imaging: PACS and specialist imaging

HBN 6 – VOLUME 2

Delivering Same Sex Accommodation – Review of Health Building Note Guidance

The Department of Health's Delivering Same-Sex Accommodation (DSSA) programme aims to all but eliminate mixed-sex accommodation from hospitals in England by 2010. Although DSSA is primarily an operational issue, the design and layout of healthcare facilities can help support the provision of same-sex accommodation. With this in mind, the Department's Health Building Note (HBN) series of publications has been reviewed against DSSA requirements.

Amendments have been made to this document at **paragraphs 2.18, 2.44 and 3.76**.

This review makes particular reference to the letter (PL/CNO/2009/2) from the Chief Nursing Officer and Director General NHS Finance, Performance and Operations at:

[www.dh.gov.uk/en/Publicationsandstatistics/Lettersandcirculars/Professionalletters/
Chiefnursingofficerletters/DH_098894](http://www.dh.gov.uk/en/Publicationsandstatistics/Lettersandcirculars/Professionalletters/Chiefnursingofficerletters/DH_098894)

Full details of the DSSA programme are at:

www.dh.gov.uk/en/Healthcare/Samesexaccommodation/index.htm



Published by TSO (The Stationery Office) and available from:

Online

www.tso.co.uk/bookshop

Mail, Telephone, Fax & E-mail

TSO
PO Box 29, Norwich NR3 1GN
Telephone orders/General enquiries 0870 600 5522
Fax orders 0870 600 5533
E-mail book.orders@tso.co.uk

TSO Shops

123 Kingsway, London WC2B 6PQ
020 7242 6393 Fax 020 7242 6394
68–69 Bull Street, Birmingham B4 6AD
0121 236 9696 Fax 0121 236 9699
9–21 Princess Street, Manchester M60 8AS
0161 834 7201 Fax 0161 833 0634
16 Arthur Street, Belfast BT1 4GD
028 9023 8451 Fax 028 9023 5401
18–19 High Street, Cardiff CF10 1PT
029 2039 5548 Fax 029 2038 4347
71 Lothian Road, Edinburgh EH3 9AZ
0870 606 5566 Fax 0870 606 5588

TSO Accredited Agents

(see Yellow Pages)
and through good booksellers

Illustrations

Please note that all network and bubble diagrams are for illustration and demonstration purposes only. Under no circumstances can these be copied or used in the production of material to specify an electronic data network or, where appropriate, new facilities.

© Crown copyright 2002

Published with the permission of NHS Estates,
an Executive Agency of the Department of Health,
on behalf of the Controller of Her Majesty's Stationery
Office.

Applications for reproduction should be made
in writing to:

The Copyright Unit,
Her Majesty's Stationery Office,
St Clements House,
2–16 Colegate,
Norwich NR3 1BQ.

ISBN 0-11-322588-1

First published 2002

Printed in the United Kingdom for The Stationery Office

Executive summary

BACKGROUND

This publication is Volume 2 of NHS Estates' guidance Health Building Note 6, 'Facilities for Diagnostic Imaging and Interventional Radiology'. Volume 1 was published in June 2001 and contains information on design of a number of types of diagnostic healthcare facilities. An Executive Summary of each volume is available from NHS Estates' website.¹ A third volume, covering extremity and open MRI and radiation protection, is scheduled for publication in the near future.

OVERVIEW

The major part of this volume reviews the built environment implications of introducing PACS into an acute hospital. It is noted that all hospitals should implement level 3 electronic patient records (EPR) by 2005, as stipulated in the Department of Health's implementation document 'Information for Health – an information strategy for the modern NHS', published in 1998. An effective Picture Archive and Communication Systems (PACS) is likely to form a major part of most organisations' EPR plan, particularly those aiming to achieve level 6 implementation.

This volume, therefore, gives substantial planning, design and background information for organisations wishing to implement the PACS element of EPR.

Also covered are the subjects of dental radiology, bone mineral densitometry and specialised facilities for neuroradiology.

A similar structure to volume 1 has been applied, with options for providing diagnostic and interventional services given where appropriate. Extensive cross-referencing between volumes 1 and 2 has been necessary. Repetition of text and guidance has been avoided where possible.

A summary of the contents is provided below.

DENTAL IMAGING

This section covers the built-environment requirements for new and refurbished dental X-ray facilities at secondary and tertiary levels. Information on facilities for

dental imaging in community dental clinics and at primary care level will be covered in future updates of this guidance or in future guidance on primary care.

Patient referral routes for secondary or tertiary level dental examinations from a range of clinicians are described in outline.

The design and installation requirements for extra-oral (or intra-oral) units and ortho-pantomograph (OPG)/dental panoramic dental-imaging systems are described. Example illustrations and dimensions are given.

A comparison is made between the three types of image acquisition approaches used in conjunction with dental X-ray imaging units. These comprise: conventional film screen, part-digital, and fully digital. The respective effects of these approaches on the built environment are described.

The provision and number of facilities at both tertiary and secondary levels is outlined and supported by architectural drawings. The effect on design requirements of sialographic examinations and other new procedures involving intervention is summarised. Additional modalities required at a tertiary referral level, such as skull X-ray imaging systems, are described in Volume 1 or will be included in future updates of this guidance.

Finally, outline engineering requirements for the installation of dental X-ray equipment and radiation protection as required by the 1999 Ionising Radiations Regulations, associated guidance notes and codes of practice are provided.

BONE DENSITOMETRY

Bone mineral densitometry (BMD) imaging and analysis systems are used to assess a patient's bone density and body composition (protein, bone, protein levels etc). Bone mineral density measurements may establish whether the patient is suffering from osteoporosis, a clinical condition marked by lower-than-normal bone mineral density.

Within the limits of existing technology, axial (whole-body) X-ray densitometry equipment is commonly used to undertake this type of patient physiological

¹ http://www.nhsestates.gov.uk/publications_guidance/index.asp

measurement. These systems can provide more accurate assessment in clinically important measurement areas such as the femur or spine when compared to peripheral measurement X-ray systems and ultrasound heel devices.

The section therefore focuses on the use of axial bone densitometers, their installation and built environment requirements, together with the associated requirements of the patient. Compared to other X-ray imaging modalities, the built environment requirements are relatively simple. These are described in this section, together with its relation to the provision of other clinical services and an overview of the engineering specifications.

The installation and built-environment requirements of the axial (whole-body) X-ray densitometry equipment commonly used to measure BMD is described. The associated requirements of the patient, provision of other clinical services, and an overview of the engineering specifications are also provided.

NEURO-RADIOLOGY

When designing a neuro-radiology facility, inter-departmental patient transfers should be made as easy as possible and kept to a minimum. This section provides sample patient journeys and relates them to the design of the built environment.

Overviews of the potential options for the provision of neurological imaging services are provided.

Any differences to the design of specialised facilities for neuro-radiology procedures are described and compared with those in Volume 1. Following additional research, reviews and further information will be provided in future updates of this guidance.

Finally, facilities needed to support a dedicated neurological imaging department are listed. This can be adapted by designers developing decentralised facilities.

PICTURE ARCHIVE AND COMMUNICATION SYSTEMS

Picture Archive and Communication Systems (PACS) offer digital archiving and retrieval of images from patient examinations and can replace the need for hard-copy film and paper storage and distribution. However, to be truly effective, PACS must be fully interfaced with other IT systems and the appropriate infrastructure must be in place to allow information to be made widely available.

This section covers all aspects of the design, installation and facilities management aspects of a PACS system. A suggested phasing and project management structure for implementing a PACS system is given, and advice is provided on how to manage the effective gradual run-down of a film library.

An overview of some of the built-environment challenges when introducing PACS into the clinical environment is provided.

An overview of the networking requirements is provided, together with illustrative network designs and a description of the built environment required to support the high-speed networking elements that facilitate the transfer of information.

An overview is given of the two information management systems, a Radiology Information System (RIS) and an Image Management System (IMS), that will be used in tandem as part of a PACS. A description of the facilities required to appropriately install the major components of these systems is included.

Lastly, a brief review is given of some of the challenges associated with the impact of the PACS on departments outside radiology. This will be expanded upon in future updates of this guidance.

Readers are strongly advised to read Chapter 3, "Imaging approach" within Volume 1 of this guidance in conjunction with the chapter in this volume on PACS.

Acknowledgements

NHS Estates would like to thank the following people, along with their respective teams and colleagues, for contributing towards the publication of this guidance:

Mark Viner, Royal College of Radiographers, Procurement Manager, St Bartholomew's and Royal London NHS Trust, London

Claire Sims, Superintendent Radiographer in MRI, Addenbrooke's Hospital, Cambridge

Craig Forster, Radiology Services Manager, Royal United Hospital, Bath

Dr Chris Rogers, Clinical Director of Radiology, Wexham Park Hospital, Slough

Eric Waites, Clinical Director for Dental Services, King's College NHS Trust, London

Janet O'Neil, Superintendent Radiographer, Walton Hospital, Aintree Hospitals NHS Trust, Liverpool

Rob Robson, Radiology Services Manager, Frenchay Hospital, Bristol

Dr Wady Gedroyc, Consultant Radiologist, St Mary's Hospital, London

The Wolfson Brain Imaging Centre, Addenbrooke's NHS Trust, Cambridge

Dewinder Bachu, PACS-NET Centre Manager, St George's Hospital, London

Sarah Bourne, Superintendent Radiographer, London Hospital Dental Institute, London

ADB Drafting Group

Andrew Sinclair, Sinclair Alanco Associates

Maryla Twin, Maryla Twin Associates

Representatives from industry

Peter West, Service Manager South-East England, GE Medical Systems

Owen Travis, Corrillion Private Finance Services, Princess Margaret Hospital, Swindon

Department of Health

Steve Ebdon-Jackson, Head of Imaging Policy Unit, Health Services Directorate

Principal authors

Jason Britton, Assistant Scientific Advisor, Engineering and Science Group, Inventures

Stephen Wolstenholme, Senior Partner, Stanhope Wilkinson Associates

Mel King, Assistant Scientific Advisor, Engineering and Science Group, Inventures

With contributions from

Nigel Tomlinson, Chief Scientific Advisor, Engineering and Science Group, Inventures

Gerald Stone, Project Manager, Engineering and Science Group, Inventures

Barry O'Connell, Consultant Engineer, Engineering and Science Group, Inventures

Steve Morgan, Consultant Engineer, Engineering and Science Group, Inventures

Contents

Executive summary
Acknowledgements

1.0 Dental X-ray imaging **page 3**

Introduction
Referral routes and clinical applications for dental radiology
Departmental planning
Room descriptions and common dental imaging equipment and installation requirements – secondary and tertiary contexts
Tertiary level requirements for the installation of specialised imaging equipment
Alternative imaging approaches and their effect on the built environment
Engineering and radiation protection requirements

2.0 Whole-body dual energy X-ray bone mineral densitometry systems **page 12**

Scope
Overview and potential clinical applications
Patient journey
The basic suite of rooms required to complete the patient journey
Room descriptions
Installation and engineering requirements for a bone densitometer

3.0 Neuroradiology in specialised tertiary referral centres **page 17**

Introduction
Provision of neuroradiology facilities
Examples of clinical procedures and related patient journeys
Particular aspects of design to support neuroradiology imaging applications
Imaging approach
Support facilities within the neurological imaging department – single departmental model only

4.0 The implementation of a picture archive and communication system (PACS) within a modern hospital **page 26**

Introduction
Challenges in the communication of digital data
Benefits and disadvantages of PACS – background information
Planning considerations when undertaking a hospital-wide PACS project
Overview of PACS and its implications for the design of the built environment
Network technologies and installation
Radiology information systems (RIS)
Image management systems (IMS)
Overview of PACS implementation outside radiology facilities

Appendix 1 Ergonomic drawings **page 54**

Glossary of terms **page 65**

References **page 71**

About NHS Estates guidance and publications **page 76**

1.0 Dental X-ray imaging

INTRODUCTION

1.1 This section looks at the requirements for configuring dental imaging facilities at tertiary and secondary levels of healthcare in the UK.

1.2 No direct reference is made to installations that could be provided in a primary care setting, within local dental practices or in a community dental clinic. However, the information provided in this section may be relevant to the design of such facilities.

1.3 Dental radiography (excluding dental CT examinations) makes up approximately 25% of the examinations undertaken in the UK annually. It is also one of the largest groups of examinations performed, matched only by chest X-rays and limb/joint examinations. However, as in the majority of examinations, the radiation exposure is relatively low. Dental radiography accounts for less than 2% of the total radiation dose given to the population as a whole from medical applications.

1.4 As is common with other areas in radiology, the rate of development of dental imaging techniques, equipment and procedures is relatively high. New dental imaging facilities, particularly at the tertiary level, should therefore be flexible and easily upgradable.

1.5 The majority of procedures undertaken in dental radiology do not involve any intervention. However, a number of interventional techniques are currently being developed and evaluated in the UK and in other countries. These may enter mainstream clinical practice within the UK at the tertiary level within the next 5–10 years.

1.6 This section focuses principally on the design requirements for the installation and operation of extra-oral X-ray and orthopantomograph (OPG)/panoramic X-ray units with cephalostat attachments. Other specialised imaging equipment may be used in tertiary centres, and more information relating to these systems will be provided in future updates to this guidance.

1.7 Extra-oral units may also be referred to as intra-oral X-ray systems, or procedures, as the examination involves placing the X-ray film in the patient's mouth. All references in this publication will be to extra-oral dental

X-ray systems. A full description of this equipment is provided in [paragraphs 1.18–1.25](#).

1.8 This section of the guidance is divided up under the following headings:

- Introduction;
- Referral routes and clinical applications for dental radiology;
- Departmental planning;
- Room descriptions and common dental imaging equipment and installation requirements – secondary and tertiary contexts;
- Tertiary level requirements for the installation of specialised imaging equipment;
- Alternative imaging approaches and their effect on the built environment;
- Engineering and radiation protection requirements.

REFERRAL ROUTES AND CLINICAL APPLICATIONS FOR DENTAL RADIOLOGY

1.9 Patients may be referred to dental imaging in a District General Hospital (DGH) or specialist centre for a wide variety of reasons. Some examples illustrating this process are given below:

- a dentist in primary care may refer patients for either extra-oral or more complex dental X-ray imaging at a tertiary or secondary centre. A radiologist or other clinical specialist may interpret the images and reports may be sent back to the dentist;
- a dentist within the DGH may see patient groups with special needs, such as people with learning difficulties or paediatric patients with particular requirements. The dentist may then refer these patients for more specialist dental X-ray imaging as part of a single episode or multiple out-patient episodes. In these cases the patients may return with their images to the out-patient dental clinic following the radiological examination. In some instances, where a hospital-wide picture archive and communication system (PACS) exists, the images may be sent digitally to the referring dentist;

- radiological imaging may be undertaken when planning orthodontic treatment associated with specialist centres. The examination would be carried out as part of an out-patient episode and the images acquired would be sent to the referring orthodontist;
- in a tertiary teaching centre, dental imaging may be used to support the full range of departmental activities including:
 - (i) dental surgery;
 - (ii) orthodontics;
 - (iii) support of maxillo-facial surgical procedures;
 - (iv) construction of prostheses;
 - (v) cosmetic dentistry;
 - (vi) periodontal procedures (gum treatments);
 - (vii) oral medicine;
 - (viii) dental A&E referrals;
- at secondary level, a number of less specialised procedures may also be carried out. These may possibly include orthodontics, cosmetic dentistry or procedures in support of maxillo-facial surgery;
- the use of diagnostic imaging in preparation for maxillo-facial surgical applications may include CT and ultrasound as well as conventional dental X-ray examinations. Conventional CT scanner facilities, shared with other clinical applications, would be used.

The imaging would take place as part of an out-patient episode or pre-/post-surgery where the patient is admitted to hospital for the procedure (for example for reconstructive surgery);
- self-referrals – for example by patients who require emergency treatment out of core working hours or who may or may not be registered with a primary care dentist;
- soft tissue investigations in tertiary centres only. Patients may be referred for diagnostic imaging of the soft tissues of the mouth and salivary glands – for example, for imaging stones in the salivary ducts or monitoring the function of the salivary glands following surgery or other treatments. This may be carried out using a variety of imaging techniques. These include:
 - (i) contrast-enhanced X-ray imaging (sialography) using a standard extra-oral unit (as described in [paragraphs 1.38–1.41](#));

- (ii) conventional diagnostic ultrasound imaging equipment, utilised as a replacement imaging procedure or in addition to those carried out in conventional X-ray rooms;
- (iii) magnetic resonance imaging (MRI), which may also be used in this context.

1.10 The spaces and rooms required to examine the broad range of patients referred for dental imaging investigations are listed in the following section.

DEPARTMENTAL PLANNING

Secondary level

1.11 At secondary level, dental imaging facilities will typically be provided as part of a larger diagnostic imaging department. The location of the facilities within the department will depend on local policies, practices and overall space allocation.

1.12 The type and number of spaces that should be provided at secondary level are listed below:

- space(s) to accommodate extra-oral dental X-ray equipment and an OPG/dental panoramic X-ray unit with a cephalostat attachment. This equipment may be installed jointly in a single room, separately in smaller adjacent spaces or in a general X-ray room;
- shared, or possibly dedicated, sub-waiting areas. The accommodation must be adequately sized to allow for large numbers of patients on a sessional basis along with relatives or carers who may be accompanying them. Where large numbers of paediatric patients are expected, shared waiting areas should be designed with the inclusion of play areas etc;
- accessible WC facilities should be available relatively close to the dental rooms and may be shared with other diagnostic imaging facilities;
- image processing and reporting facilities should be shared with other imaging modalities. The use of some digital technologies may negate the need for separate and shared processing facilities;
- an example loaded drawing of a dental X-ray diagnostic imaging suite at secondary level is shown in [Appendix 1](#). The list of rooms and the descriptions below give further information and clarification where this is required.

Tertiary level

1.13 The following spaces should be appropriate to support a throughput of approximately 100 examinations per day at the tertiary level. Departmental planning should allow for predicted throughputs and

include flexibility for an anticipated annual growth in routine examinations of at least 5–10%:

- patient waiting area for a minimum of 25 seated patients and relatives or carers who may be accompanying them;
- a two-position reception and booking counter with administration area situated behind it for the storage of records;
- accessible WC facilities, available relatively close to the dental rooms and waiting areas;
- dedicated space allocated to dental image processing and reporting facilities;
- a minimum of three separate examination bays or cubicles provided with extra-oral X-ray units;
- a minimum of two dental panoramic/OPG systems in separate X-ray rooms. These systems should be sized to incorporate a cephalostat attachment;
- a separate room for undertaking sialographic examinations using ultrasound;
- space for the installation of a skull X-ray unit, either in a dedicated X-ray room or in a room also accommodating a dental panoramic/OPG system;
- dedicated storage space;
- shared offices to accommodate students and other trainees;
- separate, but dedicated, offices for radiologists and radiographers working in the department;
- storage area for at least one mobile extra-oral unit for use in other clinical areas;

- a library/seminar room for teaching and review purposes, sized to accommodate up to 15 people;
- depending on local clinical requirements, additional space for the installation of other specialist dental radiology equipment not noted above. Members of the dental radiology department should advise on such requirements at the beginning of the project.

1.14 For general planning purposes, separate spaces for any such equipment should be allocated, sized and designed as for a small general X-ray room. It is unlikely that such spaces will have any special height requirements, but this should be checked with the specialist equipment supplier, if known.

1.15 A tertiary dental X-ray department will almost certainly provide education and vocational experience to radiography students, undergraduates, dental students and junior clinical professionals in the area of dental radiology. As such, it is advised that all the rooms, including control areas, are made larger than those provided at DGH level in order to accommodate a larger number of people. In a busy tertiary level department, at least 150 students per annum may receive training in the facilities.

1.16 Tertiary dental departments must be close to those related clinical areas to which patients may be referred. These are likely to include clinical departments such as orthodontics, maxillo-facial surgery, dental, A&E and other areas that are regularly served by the main dental imaging department. There is no requirement to site the department adjacent to the main entrance, although it is advised that directions to the facilities should be clearly signposted.

1.17 Some patients may need to be photographed as part of the preparation for maxillo-facial procedures. The relationship between the dental X-ray department and

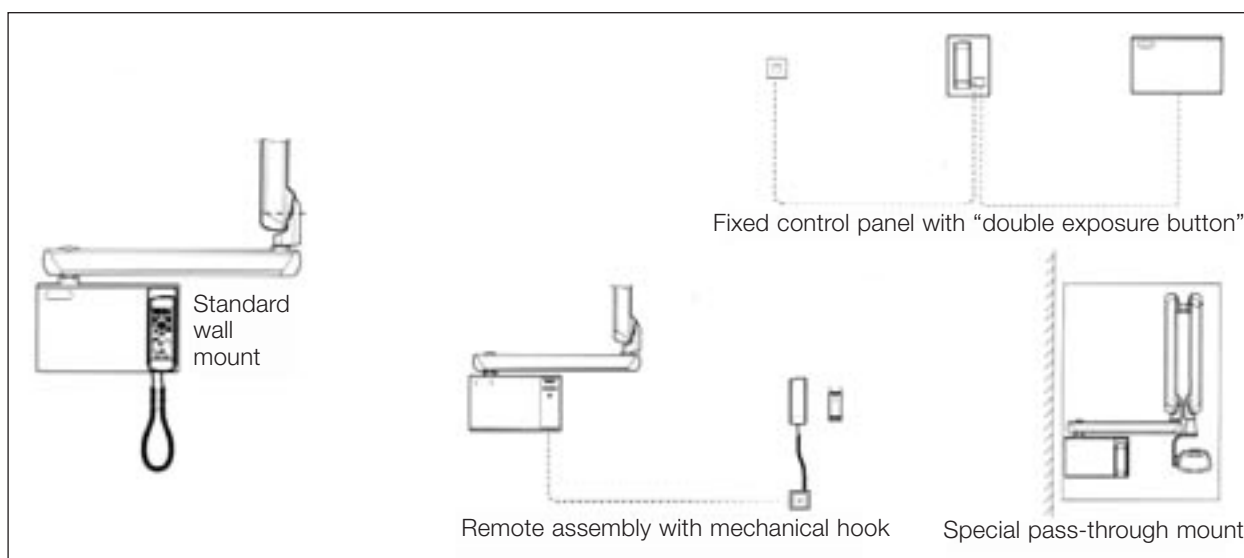

Figure 1.1 Examples of installation configurations for extra-oral dental units, courtesy Planmeca

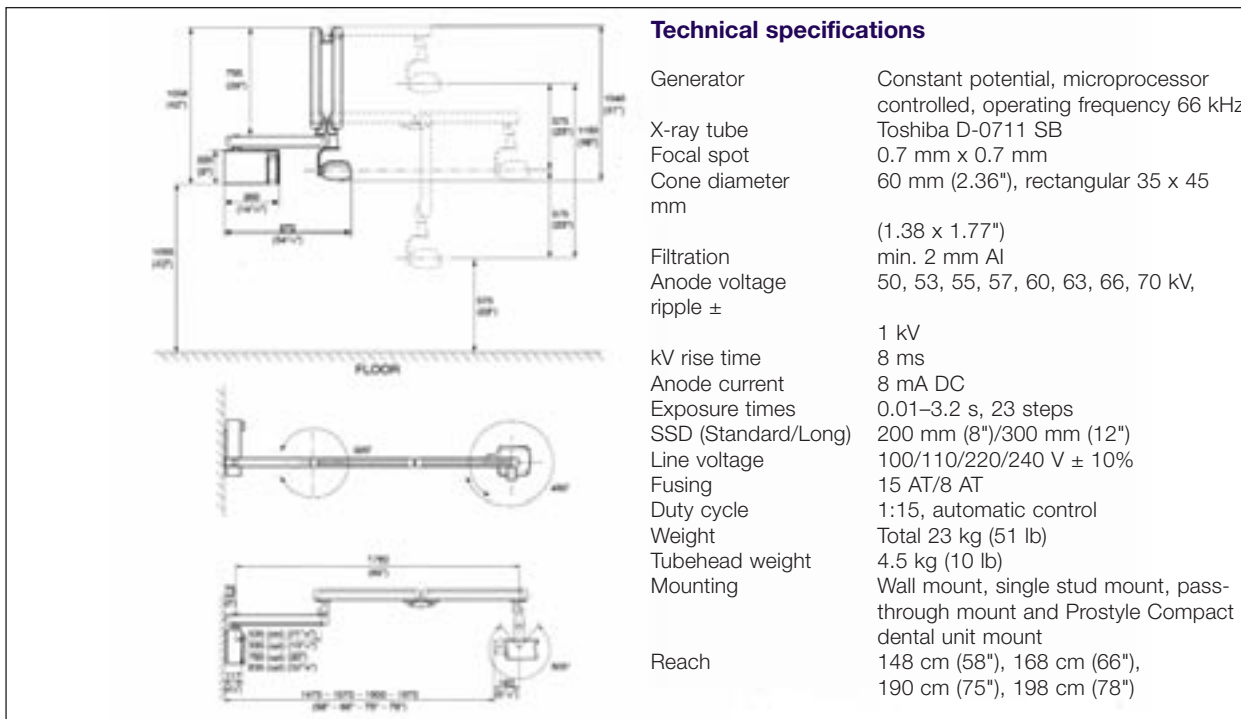

Figure 1.2 Example dimensions for a typical extra-oral X-ray unit, courtesy Planmeca

medical illustration should therefore be considered within the context of the patient's journey.

ROOM DESCRIPTIONS AND COMMON DENTAL IMAGING EQUIPMENT AND INSTALLATION REQUIREMENTS – SECONDARY AND TERTIARY CONTEXTS

Extra-oral dental X-ray equipment

1.18 The X-ray tube in extra-oral systems is a compact unit mounted on an extending, articulating flexible arm that allows for a range of X-ray projections. A variety of options are available and the supporting arm may extend up to 2 m from its mounting point. The articulating arm is usually wall- or ceiling-mounted separately from the X-ray generator. The X-ray generator is compact – 200 x 300 x 50 mm (H x W x D) – usually separate and wall-mounted close to the fixing point of the articulating arm. Local wall reinforcement may be needed to support the structure.

1.19 The X-ray unit controls may be wall-mounted in combination with the generator. Alternatively, the controls (including the exposure switch) may be mounted on a flexible lead. A wall bracket may be needed to park the unit when not in use.

1.20 An alternative arrangement is to mount the generator and control arm/tube jointly on a moveable trolley. This arrangement is more common in out-patient dental rooms as it offers greater flexibility and ability to transfer equipment between adjoining clinical spaces.

Orthopantomograph (OPG)/dental panoramic X-ray units

1.21 OPG/dental panoramic units are usually mounted on a column fixed to the floor. Depending on manufacturer, the mounting column may also extend and be fixed to the ceiling. The panoramic unit is height-adjustable to suit virtually all patients in alternative sitting or standing positions. During the examination the patient's head is fixed, using head supports to minimise movement.

1.22 The X-ray tube and image receptor-mounted, diametrically opposed, on an inverted U-arm that rotates through approximately 180° in the horizontal plane. This

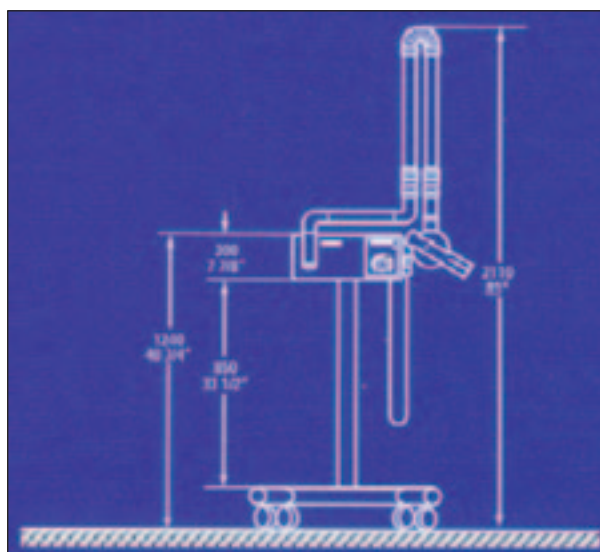

Figure 1.3 Example of mobile extra-oral unit, courtesy Sirona Dental Systems, a division of Siemens Medical Solutions



Figure 1.4 Example of an OPG/dental panoramic unit fitted with a cephalostat attachment, courtesy Sirona, a division of Siemens Medical Solutions

allows the equipment to take a single panoramic view of the whole of the patient's jaw and teeth. The detector size used to acquire the images is usually in the order of 15 cm x 30 cm, comparable to film sizes used in conventional radiography.

1.23 In the majority of cases the X-ray generator is integrated with the imaging system and separate space for this unit is not required.

Cephalostat attachment

1.24 A cephalostat attachment may be procured with an OPG/dental panoramic unit, and room spaces should be planned accordingly. The attachment is mounted on the column supporting the OPG/dental panoramic unit. The cephalostat attachment will extend at least up to 1 m away from the column of the X-ray tube.

1.25 The dimensions of the OPG/dental panoramic equipment, including a cephalostat attachment, from both sectional and plan views are shown in Figure 1.4 overleaf.

Room designs to incorporate extra-oral and panoramic/OPG equipment

1.26 Both extra-oral and OPG/dental panoramic X-ray imaging equipment have modest installation requirements compared with other X-ray imaging modalities. In the majority of cases room sizes are comparable to those provided for film-based mammography units, as described in Volume 1 of this guidance.

1.27 For rooms accommodating extra-oral equipment only, an indicative plan area of 10 m² will be appropriate. Where OPG/panoramic equipment is

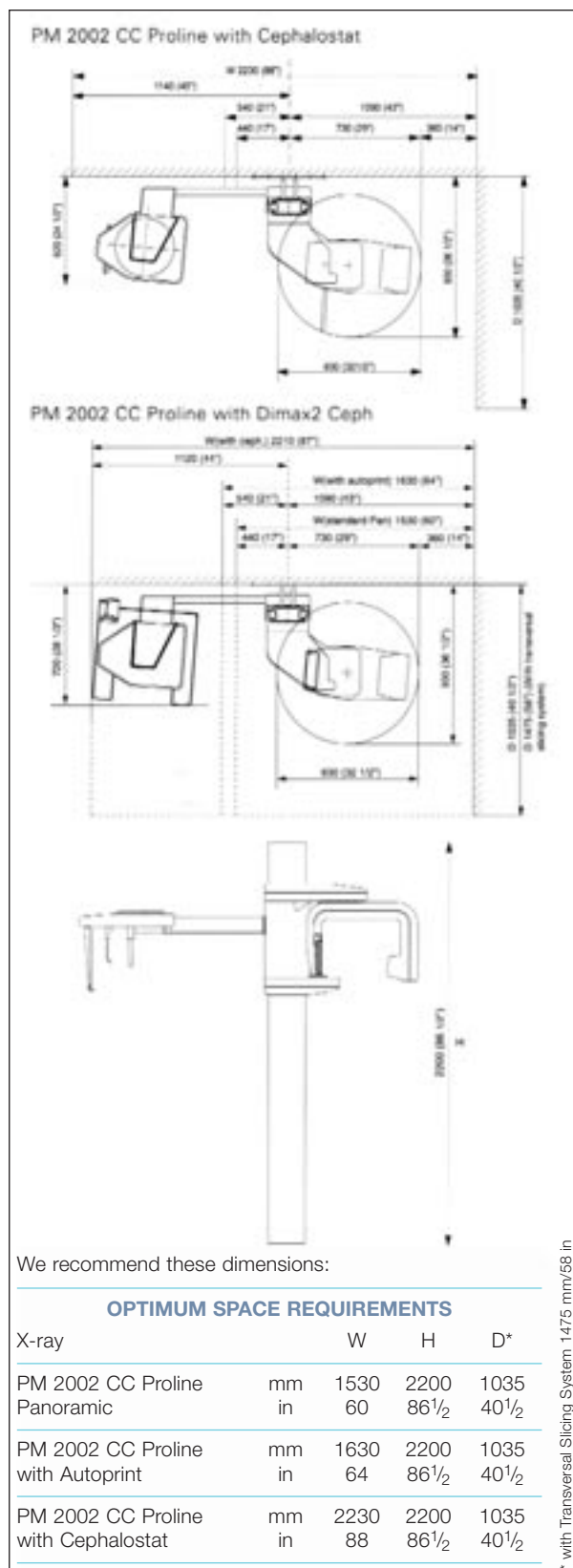

Figure 1.5 Example dimensions of an OPG/dental panoramic unit fitted with cephalostat attachment, courtesy Planmeca

installed on its own, an indicative room area of 12 m² will be needed. Where a single room is intended to accommodate both types of equipment, at least 15 m²

of space should be provided. A conventional ceiling height of 2.4 m will be appropriate in all cases.

1.28 All rooms will require a separate clinical hand-wash basin. Standard clinical finishes should be provided within the room.

1.29 A worktop incorporating cupboard storage space will be needed. This will accommodate a minimum of one computer workstation for review of patient records, an additional unit, possibly for imaging, and space for the clinicians or radiographer to review paper records. Worktop depths should be appropriate to accommodate an imaging workstation where required – that is, at least 850 mm deep.

1.30 Two wall-mounted X-ray viewers should be provided, even if the department has started using a full-digital approach. Depending on the imaging approach taken, additional space may be required for a small bench-mounted computed radiography (CR) reader to process extra-oral or panoramic and cephalostat plates.

1.31 Space will be required within the room for a height-adjustable dental examination chair. A minimum of two additional seats may be required for accompanying relatives or carers. These persons may need to wear lead aprons, if remaining with the patient when the images are acquired, and apron hangers will therefore be required in the room. The maximum number of persons in the room during an examination is not likely to exceed five at any one time.

1.32 At the discretion of the radiation protection advisor (RPA), a screened control area may be provided within a space containing a single extra-oral unit – either in the form of a mobile unit incorporating the controls or by fixed screens as used in general X-ray rooms. The RPA's recommendation will depend on the potential exposure to the operators, maximum throughput in one day and the size of the room. Local radiation warning signs should be installed, but there is no requirement for these to be illuminated or interfaced with the extra-oral X-ray equipment.

1.33 Extra-oral units may typically be installed in curtained bays or cubicles. Conventional construction to the partitions bounding each bay will usually provide appropriate X-ray protection to adjacent areas. However, the advice of an RPA should again be obtained.

1.34 Fixed screens to control areas should be provided where OPG/dental panoramic units are installed. This is because of the much higher scattered radiation doses from these units. Emergency stop controls and isolator switches for the generator should be located behind the fixed screen. As an indication, the screen will typically require a minimum of 1 mm lead equivalence at 100 kV.

However, the appropriate level of lead equivalence for the protective screen will depend on the particular room geometry and equipment usage and should be calculated by the RPA. Equal lead equivalence should be achieved in the construction of the walls to these rooms.

1.35 Where cephalostat/OPG/panoramic equipment is installed, a single-leaf door should be provided, sized to be accessible to wheelchair users and fitted with two-stage illuminated radiation warning signs.

1.36 In all cases, lighting may generally be of domestic standard but must be dimmable to very low levels (less than 2 Lux) to allow the review of dental X-ray images. Windows are not recommended unless X-ray safety and protection beyond the windows can be created – for example by local rules or physical barriers. If installed, windows will require blackout blinds so that the ambient light levels can be dimmed to the appropriate levels. Mechanical ventilation or air-conditioning will also be required.

Requirements for installation of specialised imaging equipment at tertiary level

Installation of a skull unit

1.37 This is as described in Volume 1 of this guidance but may be installed in a dental imaging department to support referrals from A&E. Ideally, this should be provided in a separate X-ray protected room, similar but smaller to those described for general X-ray equipment. This unit will be ceiling-mounted and therefore the room will require structural reinforcement and locally increased height, in accordance with the manufacturer's recommendations. A hard ceiling height of 2.9–3.1 m is required for optimal installation. Unlike other X-ray systems used in dentistry this unit will have a separate generator cabinet.

Sialographic examination and procedure rooms

1.38 The room should be similar to one allocated for extra-oral equipment, but larger. This is in order to accommodate additional equipment including an ultrasound machine and additional clinical staff present during the examination.

1.39 The room will need to accommodate a ceiling-mounted dental operating lamp, a mobile ultrasound unit and an extra-oral dental X-ray unit. Contrast media are also used during these procedures and therefore space should be allocated for the provision of additional lay-up or clinical trolleys.

1.40 This room should include user-controlled air-conditioning for reasons of patient and operator comfort during long procedures. Careful attention should be paid to the lighting in the room, with a mixture of dimmable

spotlights and fluorescent lights provided. The positioning of the spotlights should not cause any glare on the monitor screen of the ultrasound unit and enable the practitioner to view older, but relevant, films in low lighting levels.

1.41 It is likely that at least six people will be present during an examination, including the practitioner, an operator, a nurse and up to three observers or carers.

Reporting of dental examinations

1.42 In most cases, the films or images are returned to the referring clinician directly after the examination. However, a small proportion of the images may be reported by specialist dental radiologists.

1.43 A small, two-station reporting area, as described in Volume 1 of this guidance, should be provided to meet the limited reporting requirements within a specialised tertiary dental X-ray department. The detailed layout and equipment of the reporting facilities will depend on the imaging approach adopted in the department, that is, film-based or digital system.

1.44 Where a film-based system is used, special wall-mounted X-ray viewers tailored for dental applications will be required – that is, the viewing of small extra-oral and normal size OPG/cephalostat films. Integrated bench-mounted X-ray viewers may be optimal for the viewing of some smaller dental X-ray films, and their use in specialised departments may be considered.

1.45 Where a digital system with soft-copy reporting is used, two computer workstations should be installed, each incorporating a single high-resolution monitor for the display of images. The workstations may be located in the radiologists' offices or in a separate shared reporting room. The layout would be as described in the reporting room requirements section within Volume 1 of this guidance.

TERTIARY LEVEL REQUIREMENTS FOR THE INSTALLATION OF SPECIALISED IMAGING EQUIPMENT

Processing and viewing area

1.46 A separate processing area should be provided. Its size, design and requirements will depend on the particular imaging approach utilised, as described in paragraphs 1.52–1.69. Even if conventional film-based imaging methods are used when the department is first commissioned, the processing area should be planned to allow upgrading for the use of digital technologies and high-speed networks at a later date.

1.47 The design and character of the processing area will be similar to, but smaller than, a standard general radiology processing area, as described in Volume 1 of this guidance. The amount of space that will need to be

allocated will depend on the amount of equipment and size of the department.

Image distribution

1.48 In common with other diagnostic imaging applications, digital technologies and high-speed networks may provide the most effective and efficient means of acquiring, storing and distributing dental X-ray images.

1.49 Consideration should be given in planning a dental X-ray department to the need to incorporate a radiology information system (RIS) and a full PACS, interfaced where appropriate with digital systems in other radiology departments and elsewhere.

1.50 However, the clinical benefits typically accruing from PACS, in terms of efficient image storage and retrieval, may be less applicable in the case of dental imaging. Specific cost/benefit assessments should therefore be made by project teams.

1.51 The design of the dental PACS will be comparable in terms of operational requirements to those utilised in general radiology, but may be on a smaller scale. However, requirements for the volume of data and rate of data transmission will require similar networking standards and specifications to those utilised in general radiology PACS.

ALTERNATIVE IMAGING APPROACHES AND THEIR EFFECT ON THE BUILT ENVIRONMENT

Extra-oral films and images

Conventional film processing

1.52 Extra-oral X-ray examinations utilise single-use small films in disposable covers and intensifying screens. They are not placed in conventional cassettes. These are available in a variety of sizes up to 80 mm x 60 mm to suit different patients and projections. These are typically mounted on specialised film holders, which are held in position by the patient's teeth.

1.53 The films are customarily processed using a small, dedicated automatic desktop processor located in a separate darkroom. Manual handling of the films in the darkroom may be required to remove them from the single-use covers and screens.

1.54 If extra-oral dental radiographs are produced in hard-copy format, laminating them will allow for greater protection and the addition of the patient's name, hospital number etc. This should also reduce the chances of losing the items or films at a later date. Space within a shared processing or viewing area should be allocated for this purpose, together with the appropriate equipment.

1.55 In a tertiary centre, or specialised dental hospital, where the image acquisition rate is expected to be high, the processing of films may be undertaken using a high-throughput, automatic daylight unit.

Computed radiography (CR) – digital processing

1.56 An alternative image-processing option is to use small multi-use CR plates instead of conventional film. These are placed within hygienic envelopes to minimise cross-infection risks and allow re-use of the plates between different patients. The plates are comparable sizes to standard extra-oral films.

1.57 A compact desktop dental CR plate reader, typically 200 x 400 x 400 mm (H x W x D), is required to process the plates and acquire the data. These units allow the user to process up to 12 extra-oral plates simultaneously. An additional computer workstation will be required to display and view the images for technical quality. This unit can also be used to process films acquired from cephalostat and dental panoramic/OPG X-ray examinations.

Direct radiography (DR) option

1.58 Under the DR option digital images are directly acquired, processed and displayed. Extra-oral charge-coupled diode (CCD) sensor plates are available in a range of sizes with cable connections to a CCD control unit and image frame grabber. The sensor plates should be mounted within hygienic single-use covers. This allows the images acquired to be displayed using a computer workstation, possibly with a flat-screen display. The flat-screen monitor could be located close to where the patient is being treated and would allow almost instantaneous acquisition and display of the dental X-ray images.

1.59 Modifications can be made to new or existing X-ray units to allow for direct digital acquisition of dental radiological images. These changes are mainly concerned with the internal exposure characteristics of the unit and there are no changes to the overall size of the dental imaging equipment, although this does take away the need for external processing. Additional space will be needed to incorporate an imaging and processing workstation appropriately within the imaging room or bay.

OPG/panoramic and cephalostat projections

Conventional film processing

1.60 The films are of conventional sizes, usually 15 cm x 30 cm. They are similar to those used in general radiographic applications and so can usually be processed using automatic daylight or darkroom processors, as described in Volume 1 of this guidance. Depending on departmental layout and location, it may be appropriate to share the film processing and viewing

facilities of the general diagnostic imaging department. There may be a requirement to change the settings (temperature, cycle time etc) on the processor to accommodate the special needs of dental radiography.

Computed radiography (CR)

1.61 In order to acquire images using CR for OPG/cephalostat images, two options are currently available. The appropriate route will depend on the manufacturer chosen for the procurement:

- utilise standard radiographic size 24 cm x 30 cm dental CR plates. In order to allow for the use of a 24 cm x 30 cm CR plate in OPG/dental panoramic work, an adaptation may have to be made to the film cassette holder. This is not required for the cephalostat attachment as it uses standard general radiographic cassette sizes. The CR cassette/plate can be processed using dedicated or shared general radiographic CR readers and workstations, as described in Volume 1 of this guidance, provided the additional processing software has been installed;
- alternatively, 15 cm x 30 cm CR plates are available from specific manufacturers. These can be processed using a simple desktop reader, as described above for CR extra-oral plates.

Examples of the impact of CR on design of the facilities

1.62 The use of desktop and standard radiographic CR readers may replace the need for automatic, desktop dental film processors for extra-oral films. In a dedicated unit this may negate the need for a separate darkroom within a department and the space may be used for other applications, such as increasing the size of the daylight processing area to accommodate the additional equipment or providing additional dental X-ray imaging rooms.

1.63 If the dental X-ray imaging facilities are located near other imaging modalities, as may be the case in a DGH, additional space may need to be found within the central processing area to accommodate the CR readers, patient identification terminals and computer workstations.

1.64 Project teams should determine the number and type of such units required, depending on factors including:

- the current the level of CR integration applied within the diagnostic imaging department generally;
- current and expected throughput levels;
- the types of film that require processing;
- the level of redundancy necessary to ensure continuous operation.

1.65 Where CR is utilised, space should be allocated to install a desktop dry laser printer, in order that images can be reproduced in hard-copy format. Even if the department is networked and supports the distribution of images electronically, the dry laser printer will be required as a means of providing a back-up facility and for producing hard-copy images for distribution and use beyond the department.

Example of the impact of DR on the design of facilities

1.66 If the dental X-ray facilities are located within a main diagnostic imaging facility, this may negate the requirement for separate processing equipment for extra-oral films. If the department is already using CR for general radiography, the films acquired in cephalostat and panoramic projections can be processed using this equipment. This may free up some space within an existing darkroom or processing and viewing area.

Storage of dental X-ray images (OPG/panoramic, extra-oral and cephalostat projections)

1.67 All sizes of conventional dental X-ray film or laser-printed digital image, including smaller extra-oral and larger OPG/panoramic and cephalostat films, may be stored together with the patient's notes, provided these are in an A4 format. Alternatively, the films or copies may be stored in the patient's film folder and placed in the main departmental X-ray film archive. The duration of film retention is as described for X-ray films generally.

1.68 Although dependent on local and departmental policies, in the majority of instances the dental X-ray films and notes will be stored elsewhere and not within the dental imaging or general radiology department. Dental record storage facilities are therefore not described.

1.69 If digital image acquisition technologies are implemented within a full PACS environment, dental images will be stored and retrieved as for other diagnostic images, as described elsewhere in this guidance. Alternatively, in a specialist dental radiology centre, a small digital image archive may be installed together with a local network to store, retrieve and display images.

ENGINEERING AND RADIATION PROTECTION REQUIREMENTS

Extra-oral dental X-ray systems

1.70 Permanently mounted devices should have a fused spur connection fitted with isolation and emergency cut-off switches. The latter are used in the event of tube malfunction, as a requirement of 1999 Ionising Radiations Regulations.

1.71 Environmental heat-loads are normally low and there are no special requirements for room cooling or air-conditioning associated with the extra-oral X-ray equipment.

Radiation protection requirements for extra-oral dental X-ray systems

1.72 The scattered radiation levels associated with extra-oral procedures are much lower than for general and even OPG/panoramic X-ray units. The maximum beam energy used will only be up to 70 kVp as compared to 150 kVp for general X-ray systems.

1.73 For installations containing extra-oral equipment only, appropriate radiation protection will be typically be achieved by using internal partitions with 100 mm medium density blockwork and plaster finishes, or by using stud partitions achieving equivalent resistance.

1.74 Standard door construction, with a 45 mm solid softwood core and no lead lining, will be appropriate in most cases and, according to layout and control area screens, it may be possible to substitute cubicle curtains for doors. The exact requirements should be determined by the RPA.

OPG/dental panoramic and cephalostat equipment

1.75 The generator for an OPG/dental panoramic unit will be integrated into the main unit. In the majority of cases a single-phase power supply will be needed operating at 240 V and 13 A. Specified equipment suppliers should also be consulted before installation.

1.76 The systems will need to be earthed in accordance with Institute of Engineers (IEE) Regulations (16th edition) and, as for standard general X-ray rooms, there may be an additional need to provide an earth reference terminal. As with other X-ray systems, the OPG units may lose excess energy to earth following an exposure and therefore the earthing provided for dental X-ray units should be separate to that for computer systems and other sensitive electrical equipment.

Radiation protection

1.77 The maximum beam energy used will only be up to 90 kVp, as compared to 150 kVp for general X-ray systems. For installations containing panoramic/OPG equipment with cephalostat attachments, appropriate radiation protection will be achieved, in the majority of cases, by using wall/door construction and, where appropriate, floor and ceiling construction of approximately 0.5–1.0 mm of lead equivalence at 90 kV. The exact lead equivalent thickness should be determined by the RPA working in conjunction with the supplying manufacturer, and will depend on the overall patient workload and overall room geometry.

2.0 Whole-body dual energy X-ray bone mineral densitometry systems

SCOPE

2.1 This section describes the built environment that supports whole-body (axial) imaging and bone mineral density (BMD) analysis systems using dual X-ray beam technology.

2.2 The use of peripheral (heel/forearm) ultrasound and X-ray systems to measure bone density is recognised, but as the design requirements to install these systems are minimal, they will not be described in this section.

2.3 CT scanners can also provide an assessment of BMD, but the radiation doses involved are slightly higher and the scanners are only able to measure a limited number of sites when compared to axial bone densitometers. The axial systems in the majority of cases are therefore more appropriate for use when compared to CT.

2.4 This section of the guidance is divided up under the following headings:

- Scope;
- Overview and potential clinical applications;
- Patient journey;
- The basic suite of rooms required to complete the patient journey;
- Room descriptions;
- Installation and engineering requirements for a bone densitometer.

OVERVIEW AND POTENTIAL CLINICAL APPLICATIONS

2.5 Whole-body bone densitometry systems provide an accurate assessment of BMD and body composition by means of X-ray absorption. These systems utilise dual energy X-rays operating at low energies – approximately half that of standard radiographic systems. Consequently, the installation and radiation protection requirements are relatively modest when compared with other X-ray systems.

2.6 There are three main types of whole-body X-ray imaging equipment – conventional fan beam, narrow-angle fan beam and pencil beam systems. In addition, a small number of systems using sealed radioactive sources remain in use. For conventional fan and pencil beam systems, the detection system used is sodium iodide crystal – similar to that used in gamma cameras. Narrow-angle fan beam systems utilise a solid state detector. The radiation dose to patients per examination is low, typically less than 1 mSv. Figure 2.1 below shows a narrow-angle fan densitometer (GE Lunar Prodigy) and conventional fan beam system (GE Lunar Expert) scan configurations.

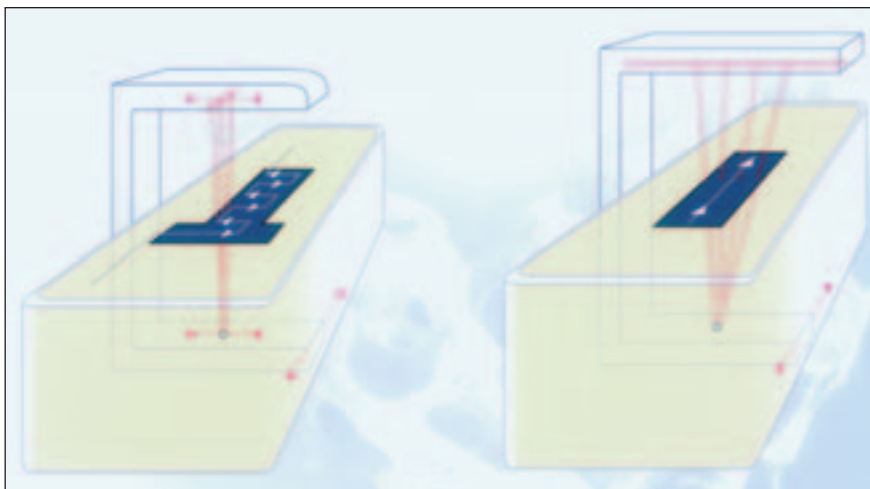

Figure 2.1 The scan configuration between a narrow-angle fan beam system and a conventional fan beam unit, courtesy GE

2.7 Whole-body imaging and analysis systems are often preferred to other types of system and approach, as they are able to assess the bone density in the spine, femur and whole body. These sites provide the clinician with the most accurate and reproducible means for assessing a patient's BMD. They are therefore suited to meet a broad range of clinical and operational targets including the assessment for risk of low-impact fractures, as outlined below in paragraphs 2.8–2.16.

Osteoporosis

2.8 Osteoporosis is defined by the World Health Organisation (WHO) as a disease characterised by low bone mass and micro-architectural deterioration of bone tissue, leading to increased bone fragility and a consequent increase in fracture risk. The WHO has identified that on a worldwide basis the problem affects one in three women and one in 12 men over the age of 50 (WHO Technical Report Series 843).

2.9 Hormone deficiencies are among the most frequent causes of osteoporosis, and women over the age of 50 are most commonly affected due to the reduction of oestrogen production during menopause. A number of studies by bodies including the Royal College of Physicians (RCP) have investigated the potential of introducing a national screening programme for this group of patients (Royal College of Physicians & Bone and Tooth Society, 2000). However, evidence collected thus far does not suggest a need for this innovation.

2.10 The Chartered Society of Physiotherapy's (CSP) guidelines on the treatment of osteoporosis identify that patients still have limited access to bone mineral densitometry X-ray facilities. As a result, the majority of referrals are for treatment rather than prevention (Chartered Society of Physiotherapy and National Osteoporosis Society, 2000).

2.11 The Royal College of Physicians' guidelines on the treatment of osteoporosis advise a measurement of bone density within the femur and the spine using dual energy X-ray techniques, as this is predictive of both fractures and vertebral compression fractures. These fractures may cause the highest levels of morbidity and mortality, with high costs of rehabilitation. The precision of error in these anatomical sites is low, and adequate reference data are available for all ethnic groups.

2.12 X-ray absorption techniques can also be used to monitor the response to therapeutic interventions by patients with osteoporosis. The spine's high concentration of metabolically active trabecular (soft, spongy) bone makes it the most suitable site for monitoring response to therapy.

Patients on long-term steroid treatments

2.13 Some patients may be taking cortico-steroid based drugs as a means of controlling other medical

conditions. Long-term administration of these drugs may cause osteoporosis. Whole-body bone densitometry units can provide an accurate assessment of these side-effects.

Prediction fractures, particularly in older patients

2.14 An assessment of femur BMD is a good predictive measure of the risk of a femur fracture and, in some cases, can aid prevention.

Endocrine disorders

2.15 A number of endocrine disorders, particularly hyperthyroidism, hyper-parathyroidism or those of the pituitary gland, may affect hormone levels which control bone regeneration and re-absorption. In large hospitals some endocrine units may be able to justify the provision of a single or multiple dedicated unit associated with the department.

2.16 Other clinical specialties, including rheumatology and general orthopaedics, oncology, renal medicine, respiratory medicine and paediatric services, may also make use of an axial (whole-body) bone densitometer.

PATIENT JOURNEY

2.17 Patients may be referred for a bone density assessment by clinicians at all levels of healthcare, including general practitioners (GPs), medical consultants and (in some cases) nurses and physiotherapy practitioners. Information about the examination, including specific requirements, must be sent to the patient before they attend the assessment. In addition, the patient may wish to access further information related to their pathology.

2.18 The majority of patients will need to undress for the examination, as their clothes may partially absorb the X-rays and render the results inaccurate. Separate changing facilities should therefore be provided. Planning decisions should take account of patient culture and preferences in terms of privacy, modesty and same-sex accommodation. Patients may also need to remove valuables, such as necklaces and watches, as these may introduce artefacts into the imaging and analysis procedure. Secure valuables storage should therefore be provided. In some cases it may be possible to share these facilities with other modalities or accommodation.

2.19 Patients may attend the imaging suite on foot or in a bed, trolley or wheelchair. Facilities should therefore be designed to accommodate this wide variety of patient groups. Frail patients may find it difficult to step up to the examination couch. A mobile patient hoist or a small step may therefore need to be provided.

2.20 Paediatric patients will be using these facilities and therefore sedation may be required. However, it is unlikely that general anaesthetic procedures will be

followed in this suite of rooms and therefore piped anaesthetic supplies will not be required.

2.21 The average length of a procedure will be 15–60 minutes, depending on the clinical requirements, procedure, machine type and age of equipment. This figure assumes that there will be adequate supporting spaces to prepare the patient before the examination. If there is a requirement to change the patient in the room, this may have a consequent effect on throughput and time taken to complete the examination.

2.22 Interventional procedures will not be undertaken in this suite of spaces.

THE BASIC SUITE OF ROOMS REQUIRED TO COMPLETE THE PATIENT JOURNEY

List of rooms

2.23 The following spaces are required to facilitate the provision of bone densitometry imaging and analysis services. The requirements are based on the patient journey and clinical requirements described above:

- imaging room. This houses the bone densitometry equipment and main control area. It will be similar in character and finishes to a standard general X-ray room, but with less rigorous requirements;
- sub-waiting area. This space allows for ambulatory, non-ambulatory and patients on trolleys and beds. It may be shared with other services or modalities;
- assisted patient changing cubicles. These could also be shared with other modalities or procedures;
- lockers – to store patients' valuables;
- reporting room – a small, one-person room to house a separate analysis computer workstation. This system would be used to perform any further analysis. Where space is limited, this could be shared with other image and data review facilities;
- recovery/induction room for paediatric patients who may need to be sedated in order to complete the examination;
- counselling room. This could be shared with the facilities provided in the main diagnostic imaging department.

2.24 In some circumstances service requirements may indicate the use of multiple units. The number of rooms and space allocated should therefore be scaled accordingly.

Location of bone densitometry services

2.25 Depending on service requirements, X-ray bone densitometry services may be provided in the main diagnostic imaging department or in association with

other units that utilise ionising radiation. This will allow for some sharing of facilities and economies of space provision.

2.26 Alternatively, some departments, including endocrine, respiratory medicine, radionuclide imaging, or other clinical facilities may support the use of single or multiple dedicated imaging rooms. The units would be installed adjacent to, or within, these clinical areas and should not be situated close to any other diagnostic imaging facilities.

2.27 It is unlikely that the bone densitometry scanner will be used to examine patients directly from A&E. A close relationship with A&E facilities may therefore not be considered essential. However, the scanner may be used to support some out-patient services, and the relationship between the scanner and these departments may need to be considered.

2.28 Access to patient information facilities should be considered when providing a bone densitometry service within a hospital or trust.

2.29 A small local inkjet printer is required for the reproduction of patients' scan results. Images are not usually used for direct diagnosis, so the resulting information can be printed onto paper using the small inkjet device.

ROOM DESCRIPTIONS

2.30 An example loaded drawing for a bone densitometry suite is shown in [Appendix 1](#). The following statements are provided to give further clarity and information.

The imaging and control room

2.31 A room size of approximately 15–20 m² will be appropriate to install the bone densitometry services and accommodate all the persons who may be present during an examination. The actual space required will depend on the original equipment manufacturer, as some systems incorporate the use of a moving couch and rotating detector/X-ray tube assembly.

2.32 The room should include the main imaging unit together with space allocated for a control area. In this instance at least 2.5 m² should be allocated to the control area, with the rest used for examination couch and ancillary equipment. Where units are installed in hospitals providing a teaching service to clinicians and radiographers, consideration should be given to increasing the size of the room, or area, allocated for control of the X-ray system.

2.33 If there is only limited space available, the size of the room can be reduced to about 10 m² if a compact pencil beam system is utilised. This is the minimum room size that will accommodate the unit and control cabinet. The space allocated for the control area should

be scaled accordingly. However, reducing the room size too much may have the effect of decreasing the levels of throughput and hindering the training and education of students and healthcare professionals.

2.34 Where possible, good access around the imaging unit should be provided in order to accommodate frail and elderly patients. As mentioned above, this group of patients may find it difficult to move onto the couch for their examination and may require a mobile hoist or other transfer equipment such as patient transfer boards.

2.35 A separate X-ray generator cabinet will not be installed as part of the equipment. The X-ray generator is integral to the primary imaging system, and additional cabinets are not needed.

2.36 Oxygen and vacuum services should be provided and there should be good access to patient resuscitation equipment. Clinical hand-washing services should also be provided in the room. It may be necessary to include access to a cold water supply for the user to undertake system quality assurance.

2.37 It will be appropriate to provide a single entrance for use by both staff and patients. If the room is large enough to allow transfer between the bed and the X-ray imaging table, the entrance doors should be large enough to accommodate a standard patient bed. In other cases, the doors should allow for patients to be moved and transferred using trolleys and wheelchairs.

2.38 At the discretion of the local RPA, the control workstation may be located behind a screen similar to those described for general X-ray installations. This will have minimal lead protection of up to about 0.3 mm of lead equivalence at 100 kV. This is generally not required for pencil beam or narrow fan beam systems as, in the majority of cases, the minimum operating

distance of 1.5 m between scanner and operator can be achieved. For fan beam systems the operating distance would be at least 2.5 m, and a lead screen may be required in smaller environments. The control workstation should be placed as far from the actual scanner as possible so as to minimise the potential radiation dose to the operator, whilst still ensuring that optimal patient management can be achieved at all times.

2.39 With most conventional fan beam systems, radiation protection requirements for the ceilings will usually be covered by the use of a concrete slab. For the walls, 100 mm high-density building blocks should be adequate. Alternatively, in some cases, adequate protection may also be achieved by adding a construction comprising two layers of 12.5 mm plasterboard to each face of a standard partition construction. The patient entrance doors may require a small amount of lead lining, up to 0.3 mm lead equivalence at 100 kV, although this will depend on the size of the room and the location of the scanner relative to the entrance doors. The radiation protection requirements must be designed in collaboration with an RPA.

2.40 In the majority of cases, there are no special radiation protection construction requirements necessary for pencil beam or narrow-angle fan beam units. This is due to the minimal scatter of radiation from these types of system. However, an RPA should again be consulted on room design.

2.41 For all types of bone densitometer, two-stage warning lights do not generally need to be provided at the entrance to the imaging room. If there is any need for these devices, it should be discussed with the RPA prior to their installation. As a minimum it is advised that removable door signs should be provided to indicate that an examination is in progress.



Figure 2.2 A Hologic QDR4500 Elite bone densitometry system

Data storage and retention

2.42 Images and data acquired from the bone densitometry procedure will be in a digital format and made available to the operator at the control console after completion of the examination. The data may therefore be moved, using a network, to a review workstation so that further post-processing can take place, or hard-copy film produced for distribution to other hospital departments. Further analysis can also be undertaken at the control workstation and the results printed on ordinary paper. A thermal or sublimation printer may be provided in conjunction with the review workstation.

2.43 Comparing results from previous scans may be helpful in areas such as the diagnosis of low bone density, osteoporosis, and in monitoring the effects of hormone or bisphosphonate treatments. Clinicians and radiologists will therefore wish to have easy access to previous outcomes and images. In the absence of PACS, the project team may wish to save the data locally to optical-based media or to provide a small digital archive. Space may need to be allocated within the suite for either of these approaches.

Sub-waiting area

2.44 Space in the sub-waiting area should be provided for at least four patients per machine, together with accompanying relatives. A curtained area should be set aside for patients waiting on beds and trolleys. Lockers for the storage of valuables should be located close to the patient waiting area. Patient toilets should be readily accessible from the waiting area.

NOTE: Preservation of patients' modesty, particularly at points of transfer between changing, sub-waiting and treatment facilities, should be given high priority, and in some cases men and women should be segregated. This may be achieved operationally or by providing separate facilities.

Greater segregation should be provided where patients' modesty may be compromised (for example when wearing hospital gowns/nightwear, or where the body (other than the extremities) is exposed. (Ref: PL/CNO/2009/2)

What about units for children and young people?

There are no exemptions from the need to provide high standards of privacy and dignity. This applies to all areas, including children's and young people's units. However, for many children and young people, clinical need, age and stage of development will sometimes take precedence. Many children and young people take comfort from sharing with others of their own age, and this may outweigh any concerns about mixed-sex accommodation. Young people should be given the choice. Toilet and washing facilities do not need to be designated as same-sex, as long as they accommodate

only one patient at a time, and can be locked by the patient (with an external override for emergency use only).

Changing cubicles

2.45 A single, patient-assisted changing cubicle per dual energy X-ray absorptiometry (DEXA) system should be located close to the main waiting area and not integrated with the main examination room.

INSTALLATION AND ENGINEERING REQUIREMENTS FOR A BONE DENSITOMETER

2.46 A standard X-ray room floor should be provided, as described in Volume 1 of this guidance. This should have a screed depth of at least 75 mm. The equipment is floor-mounted and there are no specific issues surrounding room height. The distance from the floor to the ceiling should be minimum 2.4 m. There is no requirement to provide for ceiling-mounted supporting tracks. Wall and ceiling finishes should be as for general clinical rooms, as described in Volume 1 of this guidance.

2.47 Some example engineering statistics for a bone densitometry system are given below:

- the maximum size of the main imaging units is 3.0 m x 1.5 m x 1.5 m (L x W x H). For the control workstation this system will have a maximum size of 0.75 m x 0.75 m x 1.5 m;
- the weight of the main imaging system will be of the order of 0.5 metric tonnes. If the unit is not installed on the ground floor of the building, consideration should be given to the provision of lifts able to support the weight of the systems;
- the ambient temperature in the room should be maintained at between 18 and 25°C;
- the power requirements for the X-ray bone densitometer are single phase at 230/240 V AC $\pm 10\%$, at 50 Hz;
- a separate supply for the computer system should be provided on a dedicated circuit with specifications of 230/240 V AC $\pm 10\%$, 6.5 A, 50 Hz;
- the installation of the equipment should comply with TRS89 (Medical Devices Agency, Department of Health, 1989) in terms of earthing and electrical supply arrangements.

2.48 The detector may be made using sodium iodide crystal, as is common in conventional fan beam and pencil beam systems. In certain circumstances air-conditioning may be required to maintain a constant equipment temperature and humidity. Please also refer to the radionuclide imaging section in Part 3 of this guidance.

3.0 Neuroradiology in specialised tertiary referral centres

INTRODUCTION

3.1 This section of the guidance describes the design requirements involved in providing specialised neurodiagnostic imaging and interventional services to support both neurosurgery and neurological clinical departments.

3.2 The imaging modalities and rooms used to support neuroimaging procedures are broadly similar to those described in Volume 1 of this guidance. However, in some respects, adaptations will need to be made to the room/suite design, room relationships, adjacencies to different departments and the environment services in order to meet the requirements of neurological imaging.

3.3 This section of the guidance notes the design exceptions when providing specialised neuroimaging and interventional services but will not duplicate the work undertaken in Volume 1 of this guidance. The reader is therefore advised to use this guidance in conjunction with the appropriate sections in the first document. Example designs for installations to support neurodiagnostic imaging are shown in [Appendix 1](#).

3.4 Diagnostic imaging modalities to support clinical neurological services in a tertiary centre are likely to include the following:

- neuroangiography and interventional;
- general X-ray guided interventional procedures;
- magnetic resonance imaging (MRI);
- computed tomography (CT);
- radionuclide imaging (RI);
- positron emission tomography (PET), possibly as gamma camera PET, or dedicated systems;
- general and skull X-ray facilities.

3.5 There are limitations to the use of ultrasound in neurological applications due to the bony structure of the skull. However, ultrasound imaging may be used to image vessels in the neck. Mobile ultrasound will typically be used throughout discrete areas of the neuroradiology facilities.

3.6 It is common for specialised neuroradiology services to undertake research activity as well as general clinical work. Two of the techniques currently attracting a lot of research attention are functional magnetic resonance imaging (fMRI) and positron emission tomography (PET), using a range of short-lived isotopes in addition to the more commonly used fluorine 18 (FDG). These would be used for looking at functional central nervous system response and activity rather than just anatomy.

3.7 The neuroradiology facilities will provide for both adult and paediatric patients within the same suites of rooms. Therefore, the design of neuroradiology services should reflect the needs of both these groups of patients.

PROVISION OF NEURORADIOLOGY FACILITIES

History

3.8 Although there are arguments for the integration of neuroradiology facilities within a wider diagnostic imaging department, it is observed that, in the UK, these facilities are frequently provided separately or as free-standing sub-departments. This has been driven by the need to provide essential adjacencies as described below.

Functional relationships

3.9 It is desirable for neuroradiology facilities to be near to the areas listed below (see [Figure 3.1](#)):

- neurosurgical operating theatre suites;
- critical care units (CCU);
- A&E.

Models of provision

3.10 Subject to the key relationships described above, a number of models of provision can be observed in practice. These may be considered when updating or providing new specialised neuroradiology services within a specialist referral centre. Three of these models of provision are described below:

- building a separate neuroradiology department equipped with a number of diagnostic imaging modalities, including all or the majority of those listed

above. Where such a decision is made, the location within the trust should achieve the core relationships described in Figure 3.1;

- providing separate facilities comprising neuroangiography and intervention close to the neurosurgical operating theatres, critical care units and recovery areas etc. Other modalities used to support neuroradiology, such as MRI and CT, could then be installed elsewhere in the main diagnostic imaging department. In some instances, however, there may be a need to provide urgent CT or MRI examinations for neurosurgical patients and the model described above may be more appropriate. In addition, there is a need to maintain functional integrity of the neuroradiology service offered by the hospital, and in a number of cases it may not be possible to operate the facilities in two distinct areas of the hospital. This issue should be carefully considered by planning teams at an early stage of design;
- providing specialised neuroradiology services as part of the main general diagnostic imaging department. Subject to appropriate management of the department to maintain the priority of neuroradiology, virtually all the modalities may also be used to support a broad spectrum of general radiology imaging procedures.

Planning and design factors

3.11 The overall decision by project teams as to the most appropriate approach should be based on a careful assessment of clinical standards and frameworks, medical risks to the patient and hospital policies, together with operational requirements. Some of the factors that may be considered are listed below:

- the numbers of patients requiring medical imaging or interventional procedures in support of neurological or neurosurgical services within the trust or hospital;
- the distances that patients may need to be transferred from CCU to neuroradiology facilities for imaging or interventional procedures. Local teams will consider the medical risks and difficulties of transferring patients who are on beds or trolleys, attached to life support equipment or anaesthetised/ sedated over what in some cases may be relatively large distances.

This would require a careful review of the patient journey, of which some examples are described in paragraphs 3.12–3.43, and hospital sedation and anaesthetic policies (for example, if hospital policy is to prohibit the transfer of anaesthetised patients between departments, this is likely to have a great impact on the design or the number of imaging facilities required);

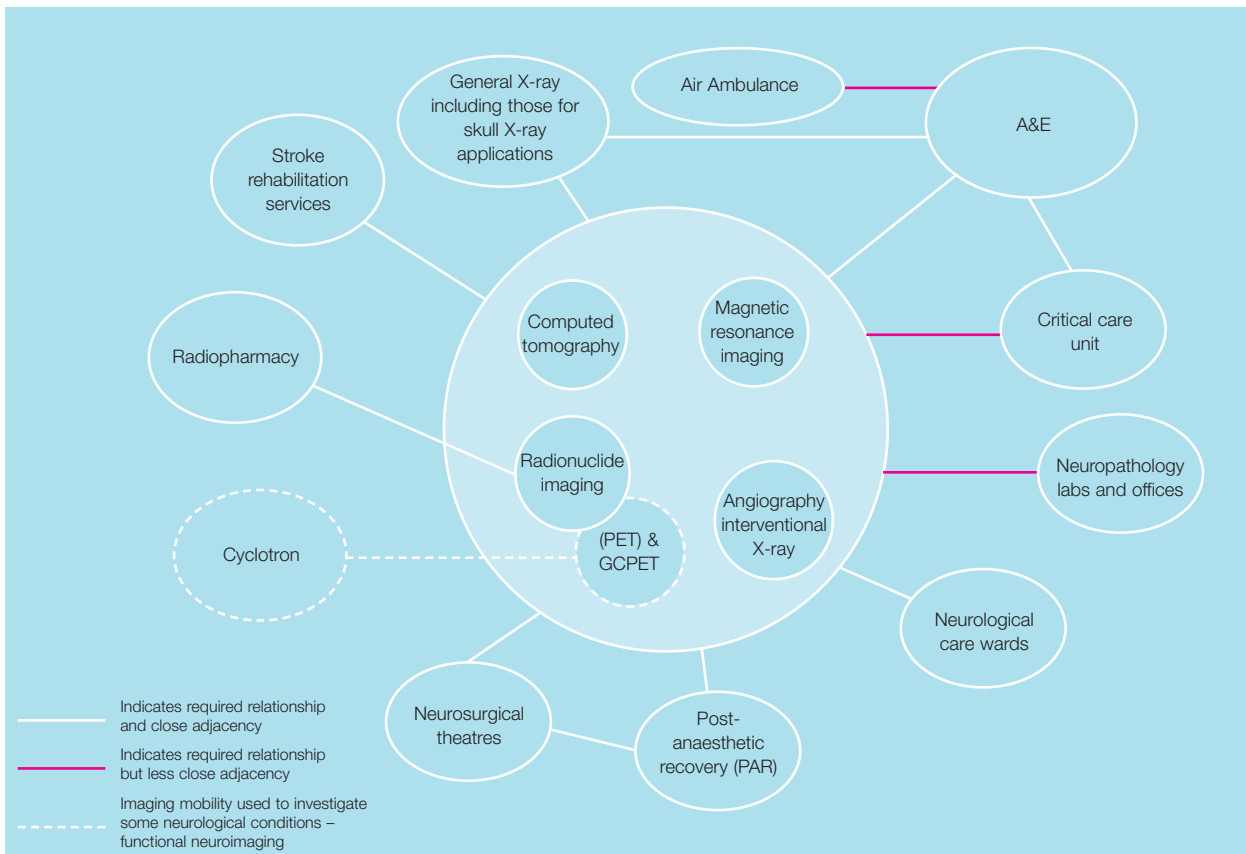

Figure 3.1 Bubble diagram showing primary functional relationships

- the potential staff workflow operational advantages of providing neuroradiology services as a single, multi-modality integrated department;
- if patients with neurological conditions or injuries are to be supported within a general radiology department, facilities will be required, such as suitably equipped preparation and recovery areas designed to care for critically ill patients;
- the ability to participate in single- or multi-centre research projects and introduce new techniques that support and improve patient care.

EXAMPLES OF CLINICAL PROCEDURES AND RELATED PATIENT JOURNEYS

3.12 This section lists some examples of patient journeys through neuroradiology facilities. It is not designed to be comprehensive, but rather an overview of some of the challenges that may be faced by planners etc.

Major head trauma including road traffic accident (RTA)

3.13 Initial assessment of such patients will usually take place in an A&E department, which should have its own general X-ray facilities, possibly together with CT. Patients requiring specialised imaging and treatment will then be transferred to a regional or tertiary neurological care centre. The transfer will be by ambulance or, in some instances, air ambulance.

3.14 Initial diagnostic images acquired when the patient is first admitted can be transmitted to the referral centre using teleradiology links. Further imaging, for instance using MRI or CT, at the specialist centre will probably be required. This is necessary to reassess the patient before decisions are made as to the most appropriate course of treatment. The images may also be used in planning for surgery, if required, as this has clear benefits of reducing potential risks during the procedure.

3.15 The distances that critically ill and medically supported patients have to travel between facilities such as A&E, neurosurgery, and neuroradiology are critical and should be carefully considered in planning new or upgraded facilities.

Critical care patients

3.16 Patients from CCU are likely to require ongoing neurological imaging and assessment. It is likely that these patients will be unconscious and have received sedation and other forms of pain relief. It is also likely that they will be attached to a ventilator and a number of patient-monitoring devices. Specialist nursing staff, and possibly other clinicians including anaesthetists, will accompany the patient when he/she is transferred to the neuroradiology facilities and into the imaging room.

3.17 As discussed, the distances over which the patients have to travel between departments should be an important consideration for the provision and location of the neuroradiology imaging services.

Patients with oncological disorders

3.18 Initial assessment of patients for neurological conditions may take place within a general diagnostic imaging and interventional radiology department. Following a suspected diagnosis of central nervous system (CNS) cancer, they may then be referred to the neurological centre for further diagnostic assessment, image-guided biopsy procedures and treatment using surgery. Alternatively, this next stage of specialist neurological imaging and treatment may take place within a dedicated cancer centre – if the centre includes the appropriate facilities and required staff, such as neuroradiologists.

3.19 For these procedures staff should be appropriately skilled. Specifically, neuroradiologists and neurosurgeons should be available to supervise and interpret the results from the examinations.

3.20 Neuroradiology would be used to locate the position of tumours in three dimensions within the brain for biopsy or subsequent surgical procedures. These locational techniques include frame-based or frame-less stereotactic procedures.

3.21 Frame-based procedures require the patient to be fitted with a stereotactic frame, and this is undertaken in the operating theatre under general anaesthesia. The patient is then transferred, whilst still anaesthetised or heavily sedated, to the MRI and/or CT scanner and imaged with the frame in situ. Depending on the techniques utilised by the centre, patients may undergo MRI or CT scanning on their own or in succession. Using the images acquired of the patient's brain, together with the stereotactic frame, it is possible to calculate the spatial location of the tumour inside the patient's head relative to the frame. The patient is then transferred back to the operating theatre, where the surgical procedure is undertaken using the spatial co-ordinates derived from diagnostic imaging. The stereotactic frame is then removed.

3.22 The patient will need to recover following the procedure, and the biopsy samples, where relevant, will be prepared and analysed in the neuropathology department. This may in some cases be adjacent.

3.23 If the imaging facilities, neurosurgical operating theatres and critical care units are remote from each other, project teams must allow for the provision of dedicated electromechanical lifts or covered walkways. When constructing these walkways or lifts, attention should be paid to providing a level floor surface with the minimum number of discontinuities.

3.24 Stereotactic radiosurgery may be undertaken utilising gamma knife technology (see [Glossary](#)) within the neurosurgical operating department. The interface for the communication of information between the neuroradiology facilities and operating theatres should be integrated into the design. In particular, MRI and neuroangiography need to be considered at early planning stages. This planning needs to extend beyond the use of data communication links and take into account other organisational and relationship perspectives.

Image-guided interventional neurovascular treatments

3.25 The use of imaging-guided, interventional neurovascular treatments (interventional neuroangiography) is relatively new, but is gradually becoming part of standard clinical practice and procedures within a number of centres in the UK and worldwide. The procedures are considered to be a potentially safer alternative to neurosurgery for those patients who are at significant risk of major neurological deficit or death due to haemorrhage in the brain caused by arteriovenous malformations (see [Glossary](#)) or other related conditions.

3.26 The interventional therapies available fall into three broad categories – cerebrovascular embolisation, angioplasty, and direct intra-arterial infusions (see [Glossary](#)). Interventional procedures have in some cases replaced more invasive neurosurgical procedures or provided options where neurosurgery was not considered to be clinically appropriate.

3.27 Patients who have a neurovascular defect may undergo initial imaging and diagnosis within a non-specialised centre such as a DGH. They may then be referred to a specialised neurological centre for further assessment. The patient may then be treated using an interventional imaging procedure alone or in combination with neurosurgery.

3.28 The use of interventional angiography as a stand-alone procedure should avoid the need for surgery and result in a shorter stay in hospital and an earlier return to normal activity.

3.29 X-ray neuroangiography suites for interventional procedures should ideally be dedicated areas. They should also be constructed adjacent to, or as part of, the neurosurgical operating department for the following reasons:

- the majority of procedures will carry a relatively high medical risk and, on occasion, patients will need to undergo neurosurgery, particularly if complications develop during the interventional procedure. In these instances, the distance over which the patient is

transferred will become medically important. Thus, the operating theatres and neuroangiography facilities need to be close together;

- the recent enquiry into the performance of paediatric cardiology services at Bristol Royal Infirmary (Bristol Royal Infirmary enquiry final report) highlighted problems in the discontinuity of care and communication breakdowns due to the cardiologists and cardiac surgeons being located in distinct, separate facilities. Continuity of patient care will be extremely important if interventional techniques are used in combination with neurosurgery. To be successful, good communication and patient focus within the multidisciplinary professional care team are essential;
- it is unlikely that the highly specialised neuroangiographic equipment will be suitable for use in other similar vascular procedures as the set-up of the unit will be configured for cerebral or brain imaging. For infection control reasons, project teams should discourage the use of the equipment for the majority of non-vascular interventional purposes;
- the cost savings generated by the unit in obviating the need for some neurosurgical procedures, together with reduction in patient stays, could be used (when constructing a business plan) for the installation of a new separate neuroangiography unit in conjunction with a neurosurgical operating department;
- patients will need to be monitored and observed during the recovery from the procedure and the effects of anaesthesia. The post-anaesthesia recovery (PAR) room may appropriately be shared between neuroangiography and neurosurgery facilities, if these are adjacent.

Stroke – current and future applications

3.30 In current UK practice, diagnostic imaging of the majority of stroke victims will take place primarily within a DGH. Current national frameworks for older people and cardiac disease ('National service framework for coronary heart disease: modern standards and service models', Department of Health, 2000; 'National service framework for older people', Department of Health, 2001) also support the provision of additional MRI imaging capacity for the diagnosis of stroke patients.

3.31 New techniques in monitoring the initial onset and rehabilitation of stroke patients, such as diffusion-weighted imaging, fMRI and magnetic resonance spectroscopy (MRS), are being introduced in a number of centres.

3.32 In addition, interventional procedures for the early treatment of strokes are being developed and may enter

UK medical practice following further evaluation and research. Therefore, greater numbers of stroke patients may in the future receive both imaging and treatment in specialised neuroradiology facilities. However, there are probably not enough trained radiologists available within the UK to support the introduction of this service and therefore it is unlikely to enter mainstream practice in the near future ('Clinical Radiology – a workforce in crisis', The Royal College of Radiologists, 2002).

Degenerative or chronic neurological conditions

3.33 A specialist neurological imaging facility may also serve patients who have degenerative conditions affecting the brain, such as Alzheimer's and Parkinson's diseases or general dementia.

3.34 These patients are likely to be elderly and may be treated on an out-patient/day-patient basis. For such patients, MR scans will commonly be used to form diagnostic images of the brain anatomy to assess the progression of their conditions.

3.35 Initial research with PET has shown a great deal of potential in diagnosing patients with the early signs of Alzheimer's and Parkinson's diseases. PET has the advantage of being able to easily demonstrate physiological/functional as well as anatomical information. However, it is observed that PET is not currently provided in the majority of neurological imaging facilities in the UK.

3.36 The majority of patients imaged in this group will be out-patients. It is unlikely that any interventional procedures will be undertaken with this group of patients. Other imaging modalities are likely to include CT and RI.

3.37 Research may be undertaken with some patients using fMRI and MRI spectroscopy. These techniques may involve slight adaptations of the scanner, such as the use of dedicated receiver or gradient coils. In other respects, conventional 1.5 T (Tesla) MRI scanners will be appropriate for use in these techniques.

3.38 Alternatively, higher field scanners (above 1.5 T) may be used for both research and clinical applications in fMRI and MRI spectroscopy, as these offer enhanced quality of diagnostic images. Installation requirements for higher field strength scanners are described in [paragraph 3.57](#). The installation of 1.5 T systems is described in Volume 1 of this guidance.

Spinal injuries

3.39 Some patients with long-standing spinal injuries and paralysis may require CT and MRI imaging periodically to assess the benefits of treatment and long-term rehabilitation. Specialised beds and transfer techniques may be required for such patients.

3.40 A myelography service will need to be provided for those patients who are unable to undergo MRI. In addition, some centres also undertake specialised imaging and interventional procedures within the spine. As such, either interventional fluoroscopy facilities should be provided as part of a neuroradiology service, or access to these units should be made available.

Epilepsy

3.41 Children and adults may be assessed for epileptic conditions. This may involve the administration of certain drugs to control the seizures or identify the type of epilepsy involved. PET, MRI or CT and SPECT (see Glossary) may also be used to provide functional information, particularly in assessment of potential neurological deficit if palliative or curative surgery is contemplated in a specific anatomical area of the brain. Neurological imaging services may be provided to a local epilepsy treatment centre, as defined by the Clinical Standards Advisory Group (CSAG) ('Services for patients with epilepsy', 1999).

3.42 Wada tests are commonly undertaken in neuroradiology facilities to investigate the activity and involvement of separate hemispheres in epilepsy. The test also consists of behavioural testing. A small amount of anaesthetic is injected into either the right or left internal carotid artery. Clinical teams have a small amount of time (before the drugs wear off) to observe the activities of one of the hemispheres as the abilities of the other hemisphere are suspended. The investigation is important in surgical planning as it will allow the surgeon to determine the potential neurological deficit, such as the effects on language capabilities, following the surgical procedure.

3.43 In order to support this procedure, facilities should be provided to support the administration of the anaesthetic drugs and to allow the patient to recover following this investigation, as they may be disorientated and amnesic due to the effects of the drugs.

PARTICULAR ASPECTS OF DESIGN TO SUPPORT NEURORADIOLOGY IMAGING APPLICATIONS

3.44 Paragraphs 3.46–3.68 give details of the special aspects of neuroradiology facilities, where these differ from standard modality installations described in Volume 1 of this guidance.

3.45 Depending on local circumstances, there may be a case for providing piped anaesthetic gas services to all neuroradiology services. This should be discussed by project teams at early planning stages and included, if considered necessary, to support the provision of clinical services.

Neuroangiography facilities

3.46 The general types of imaging equipment, the design and the layout of the imaging room will be similar to that for vascular interventional imaging procedures, as described in Volume 1 of this guidance. A large proportion of neurological angiography patients will require general anaesthesia before the intervention is performed, and appropriate supporting spaces will be needed for induction of anaesthesia.

3.47 All neuroangiography rooms should allow for interventional procedures to be carried out and should be designed and equipped accordingly. Particular attention should be paid to the requirements for clinical cleanliness and to appropriate rates of supply and extract ventilation with the use of high-efficiency particulate air (HEPA) filters. In general, the standards of cleanliness applied should be the same as those used in operating theatres. Advice from the infection control team should be sought when designing the interventional facilities.

3.48 Supporting spaces required adjacent to the imaging/interventional room will include a clean utility/lay-up, scrub-up bay and an anaesthetic bay. Other supporting areas, not necessarily immediately adjacent but requiring good access, will include recovery, clean store/TSSU and staff changing facilities for theatre gowns and clothing ("blues"). A machine room and an X-ray control area should be provided separately to the imaging room.

3.49 The imaging equipment used for neurological applications in X-ray angiography is likely to consist of bi-plane C-arm equipment, as described in Volume 1 of this guidance. Bi-plane units may reduce the patient's exposure to ionising radiation and reduce the amount of contrast media needed per examination. This is important when undertaking procedures with young paediatric patients and will greatly facilitate rotational angiography examinations (see [Glossary](#)). Where bi-plane equipment is proposed, designers should be aware that at least four (up to a maximum of six) image review monitors will need to be mounted onto ceiling tracks within the main imaging room.

3.50 Even where project teams make a decision to procure single-plane units, the room should be made large enough to accommodate bi-plane units as a possible future procurement or replacement.

3.51 A room in excess of 50 m² is likely to be required to accommodate this type of equipment together with the large number of staff present (up to approximately ten people, including students). The machine will be similar to the conventional C-arm single- or bi-plane units, as described in Volume 1 of this guidance, with the exception that they will have a relatively small image

intensifier of 23 cm and be optimised for undertaking neurological imaging.

Computed tomography (CT)

3.52 The layout and equipment to support CT imaging in neuroradiology cases is similar to that already described in Volume 1 of this guidance. All CT scanner rooms should allow for life-support, including piped gases and monitoring equipment, and additional numbers of essential staff who may remain in the room during the X-ray exposure. It is advised that any CT room could be used for neurological purposes, provided the appropriate support facilities are available. Lead aprons and other radiation protection equipment should be provided in the CT scanner room for at least five members of staff, and the walls may need to be structurally reinforced to take the weight of the jackets and other equipment.

3.53 The control room should be sized to allow for anaesthetic monitoring equipment to be installed, together with space for nursing staff and other clinicians to remain in the control area during scanning, if required.

3.54 Based on local policies, practices and procedures, the waiting area serving CT may also be equipped with life-support equipment including gas outlets.

3.55 An adjacent reporting and post-imaging reconstruction room is required, particularly in neurological departments for the creation of 3D images used in the planning of further treatment including surgery.

Magnetic resonance imaging (MRI)

3.56 The layout for a 1.5 T MRI scanner room used in neurological applications is similar to that described in Volume 1 of this guidance.

3.57 Project teams considering the installation of 3 T systems should make allowance for the following factors:

- 3 T systems are heavier than 1.5 T systems – 15 metric tonnes as opposed to 7 metric tonnes for an actively shielded 1.5 T MRI system. This may affect access requirements for magnet replacement;
- the fringe fields for the systems are much larger and therefore a larger room may be required to install the system. Alternatively, magnetic shielding may need to be incorporated into the structures surrounding the MRI system;
- the scanner's footprint may be larger when compared to 1.5 T machines. The examination room may have to be made larger to accommodate this.

3.58 For fMRI applications, imaging procedures will need to be carried out whilst the patient undertakes a designated cognitive task, for example looking at a particular set of images. Visual and auditory stimuli will be presented to the patient through goggles and headphones. The room should be designed to minimise external stimuli by dimming lighting to blackout levels. The patient may be provided with hearing protection, or possibly ear-defenders, to reduce the background noise from the gradients and the cooling system. The use of acoustic shielding in the room construction should also be rigorously considered.

3.59 The MRI unit may be equipped to undertake MRS examinations, and some additional space may be needed for additional equipment such as receiver coils. The requirements for each manufacturer will be different and should be checked before finalising the examination room design.

3.60 A small proportion of patients receiving neurological MRI imaging will require general anaesthesia or sedation. A significant proportion of these will be paediatric patients on a pre-booked, sessional basis, but these may also be patients from critical care who also require life-support and monitoring facilities. An anaesthetic/recovery and holding area for such patients must be provided adjacent to the MRI scanning and control room. An additional or shared facility should also serve the CT suite.

3.61 If the anaesthetic equipment is to be taken into the examination room, careful attention should be paid to the following within the overall risk management strategy for the MRI suite:

- is the anaesthetic equipment MRI-compatible? The equipment procured should be compatible with the MRI environment in being unaffected by the strong magnetic field. Some devices may be compatible with 1.5 T magnets, but this may not hold true for higher-strength field scanners such as those operating at 3.0 T, as described above. The effects that the anaesthetic equipment has on the function of the scanner should also be considered, and devices purchased with additional radiofrequency shielding if needed. In some instances, additional space may need to be provided to ensure that interference between the medical device and the scanner does not occur, and this should be accounted for in the design of the examination room;
- although the device may be MRI-compatible in that it does not represent a direct safety risk to either patients or staff, it needs to operate reliably within the magnetic field environment. The monitors should be tested within the environment before being used with patients, particularly for 3.0 T scanners;

- all equipment that is considered to be compatible within the MRI environment should be appropriately marked and possibly segregated from other equipment that is considered non-compatible. Storage within the unit may need to be found to support this operational requirement;
- in some instances, the anaesthetist and assisting staff may wish to remain with the patient during the procedure inside the examination room, and appropriate space should be provided. Alternatively, the anaesthetist may take a precautionary approach to their own exposure to the static magnetic field. Current guidance (not backed by any scientific evidence) suggests this should not be more than 0.2 T weighted over a period of 24 hours (Radiology Information Systems Board of Faculty of Clinical Radiology, 2000). The design of the suite should therefore allow for both approaches, with the anaesthetist and assisting staff remaining within the control room or in the examination room.

3.63 A larger control area and viewing panel should therefore be provided to accommodate the anaesthetist, other clinical staff and additional remote monitoring equipment. In addition, space should be provided within the scanner room for MRI-compatible equipment to undertake anaesthesia and monitoring of patients undergoing imaging procedures.

3.64 A small MRI reporting area should be provided adjacent to the control area for 3D-image reconstruction and treatment planning.

3.65 Interventional MRI techniques for neurological applications are currently well integrated in modern practices in other European countries such as Germany, but are in early stages of development within the UK.

Radionuclide imaging – gamma cameras and radiopharmacies

3.66 These facilities may be required, but will not significantly differ from those described in Volume 1 of this guidance.

Positron emission tomography (PET)

3.67 PET is currently rarely used as part of neurological imaging in the UK. This may change under future policy and national procurement initiatives.

3.68 The facilities required are similar to those described in Volume 1 of this guidance. The exceptions to support neuroradiology are as follows:

- space will need to be allocated within a larger scanner room to accommodate additional life-support equipment together with additional

personnel. An indicative scanner room size will be approximately 35–40 m²;

- a holding/anaesthesia/recovery area should be provided in support of the PET scanner room;
- where a cyclotron is provided on site, there may be opportunities to undertake imaging research with very short-lived radionuclides such as Oxygen 15. This will require a directly piped connection from the adjacent cyclotron and radio-chemical production facilities to the scanner room. The radioactive liquid or gases will be administered to the patient concerned whilst they are undergoing imaging.

IMAGING APPROACH

3.69 Because of the imaging modalities used, most of the images acquired in the neurological imaging department will be inherently digital. Therefore, the most effective means of storing and distributing these images may be the use of a mini-PACS system. This might serve only this department, but could also be part of a hospital-wide PACS.

3.70 Project teams should also consider the provision of conventional processing and viewing areas, together with reporting and storage facilities. These may still be required in support of any plain film radiology or part-digital approaches, if carried in association with neuroradiology. Some of these facilities, particularly storage of films, may be integrated with the general diagnostic imaging facilities.

3.71 Dry laser printers will be required as primary or back-up facilities – for example, during major system upgrades and failures or possibly for the distribution of images to other hospitals, departments or clinicians without digital viewing facilities. At least two dry laser printers should be provided, possibly on a separate network to that of the PACS. Some continuing use will be made of conventional X-ray film in neurosurgical operating theatres, and conventional X-ray viewing boxes will still be required.

3.72 Teleradiology facilities should be provided to export images to neuroradiologists' homes for out-of-core-hours consultation and reporting. These facilities will be used to import images from other non-specialist hospitals for neuroradiology reporting and prior to the transfer of patients from other healthcare centres.

3.73 Monitoring of progressive diseases and impact of drug regimens and treatment will typically be from images acquired in CT, MRI and radionuclide imaging. Neuroradiologists will need to frequently review imaging studies that may be five, or occasionally up to ten, years old, and this influences the design of a mini-PACS system if installed. Please also refer to the section on [PACS, Part 4](#) of this guidance.

3.74 Images from functional PET and anatomical (CT/MRI) imaging modalities may be fused to form composite images, principally for cancer treatment planning and assessment. These may make use of the same workstation facilities undertaking 3D reconstructions, or be provided separately in the department.

3.75 Images may be acquired and displayed in the neurosurgical operating theatres with mobile ("mobile C-arms") X-ray image intensifiers, as described in Volume 1 of this guidance. These images will be transferred by the use of secondary capture devices and network connections and then stored as part of the mini-PACS system.

SUPPORT FACILITIES WITHIN THE NEUROLOGICAL IMAGING DEPARTMENT – SINGLE DEPARTMENTAL MODEL ONLY

3.76 The following spaces are required to make up a neurological imaging department, where this is planned as a coherent free-standing unit. These spaces are in addition to those described above:

- staff offices;
- general reporting areas for both digital and hard-copy film reporting;
- space for data-network hub/switchcupboards (including teleradiology links such as ISDN) and related data archives, possibly elsewhere on site;
- staff toilets;
- public toilets;
- reception areas plus supporting office (this should include some space allocated to a records area);
- a main waiting area for at least 30 people (in proportion to six to seven imaging rooms) and additional sub-waiting areas, including facilities for ambulant patients and bed/trolley bays for non-ambulant patients. The sub-waiting areas should be adjacent to each modality and sized according to anticipated patient category, as described in Volume 1 of this guidance;
- patient changing facilities, ideally close to the sub-waiting areas (the numbers of these facilities were indicated in Volume 1 of this guidance);

NOTE: Preservation of patients' modesty, particularly at points of transfer between changing, sub-waiting and treatment facilities, should be given high priority, and in some cases men and women should be segregated. This may be achieved operationally or by providing separate facilities.

Greater segregation should be provided where patients' modesty may be compromised (for example when wearing hospital gowns/nightwear, or where the body (other than the extremities) is exposed). (Ref: PL/CNO/2009/2)

What about units for children and young people?

There are no exemptions from the need to provide high standards of privacy and dignity. This applies to all areas, including children's and young people's units. However, for many children and young people, clinical need, age and stage of development will sometimes take precedence. Many children and young people take comfort from sharing with others of their own age, and this may outweigh any concerns about mixed-sex accommodation. Young people should be given the choice. Toilet and washing facilities do not need to be designated as same-sex, as long as they accommodate only one patient at a time, and can be locked by the patient (with an external override for emergency use only).

- dedicated staff changing areas;
- dry laser printing areas for the generation of hard-copy images;
- a counselling and interview room;
- a general clean store for catheters and other prepared disposable sterile equipment. This would be supported by TSSU/SSD facilities elsewhere.

4.0 The implementation of a picture archive and communication system (PACS) within a modern hospital

INTRODUCTION

4.1 Picture archive and communication systems (PACS) are a modern, computer-based means of storage, distribution and copying of medical images in electronic or digital form. The technology is complex and capital-intensive but may be expected to bring significant rewards in terms of enhanced patient care and process efficiency.

4.2 Much of the advantage gained is derived from the relatively rapid storage and movement of information that the technique readily affords. The ability of PACS to permit rapid interpretation of images by radiologists, and the combined attribute of facilitating access to radiological information by other members of the multidisciplinary healthcare team, has driven the expanded use of this option.

4.3 The PACS concept was first identified in the early to middle 1980s, but the first systems were not fully implemented until the beginning of the 1990s. This was mainly due to the limitations in the development of emerging technologies.

4.4 One of the prime motivations for the implementation of PACS worldwide has been the improved efficiency of radiology services. This has been particularly important as financial reimbursements received by hospitals for undertaking diagnostic examinations have become smaller each year. This reduction has occurred against a background of increased patient expectations for shorter waiting times and greater accuracy in diagnosis.

4.5 In the UK, the majority of new private finance initiative (PFI) healthcare building projects now incorporate hospital-wide PACS as part of a wider electronic patient record (EPR) information technology implementation. Several older hospitals have installed PACS or are preparing business cases for its installation. An estimated 10–15 full, hospital-wide PACS are in operation in the UK. The number of full PACS under construction or in use in the UK is therefore relatively small when compared to other countries such as the USA.

4.6 Several UK hospitals have installed 'mini-PACS' (as briefly described in Volume 1 of this guidance). These systems do not cover the whole hospital and are

typically limited either to parts of a diagnostic imaging department or to discrete modalities. This guidance focuses on the design challenges of installing a hospital-wide PACS system in an existing hospital. It will not generally consider the requirements for 'mini-PACS'. However, it is acknowledged that some hospitals or departments may use the installation of a 'mini-PACS' system as part of the process of developing a full PACS.

4.7 For the full advantages of PACS to be realised, the system must work closely, and be successfully interfaced, with the hospital information system (HIS). The hospital's networking infrastructure should support the distribution both of radiological images and, most importantly, of text-based reports (radiological information) throughout the hospital. Options to facilitate the distribution of information to other departments within the hospital are presented in this guidance.

4.8 A PACS-compatible HIS should be constructed and operational before PACS technologies are implemented. If a PACS system is implemented locally, and only in the diagnostic imaging department, images and reports will still have to be printed and distributed to other departments in the hospital by conventional processes. In this scenario, much of the system's potential patient care and economic benefits will not be realised. This section is therefore aimed at hospital project teams wishing to make the transition to a full hospital-wide PACS system, either separately or as part of a full EPR implementation.

4.9 In developing PACS within a hospital, the importance of initial operational analysis in reviewing information, staff and patient flows – together with the delineation of target benefits – cannot be over-emphasised. PACS technology and implementation places special demands on an organisation and will necessitate the retraining of managers, healthcare teams and clinicians.

4.10 The implementation of PACS is economically cost-neutral when balancing the costs of the technology against reduced use of materials, improving working processes and staff workflows etc. However, there is currently little evidence to support this. The major benefit of PACS should therefore be in the improvement of overall patient care and the prompt use of information in the efficient delivery of services. A simple example

would be to look at the potential impact of PACS on orthopaedic out-patient clinics. PACS should enable a reduction in the number of out-patient attendances when patients have to attend for both clinical consultant and radiology appointments. Following the completion of the examination, the radiological report and associated information should be made quickly available to the responsible clinician. They will then be able to communicate the results to the patients concerned to enable diagnosis and change ineffective treatments promptly. In using PACS there should be no requirement for the patient to make a further appointment to see the consultant concerned to discuss the results of the radiological examination.

Assumptions

4.11 The information provided in this section is based upon the following assumptions:

- that the PACS in a diagnostic imaging department will be implemented together with a high-speed data network, radiology information system (RIS) and HIS and interfaced appropriately to allow information flow through all three systems;
- that this guidance aims to assist those existing departments that wish to implement PACS and are currently utilising a mixture of fully conventional and/or part-digital solutions, as described in Volume 1 of this guidance;
- that this guidance may also be applicable for those wishing to implement a full PACS/RIS/HIS information system within new hospitals, such as those currently being constructed under PFIs.

Structure

4.12 This section of guidance outlines the planning and design challenges associated with hospital-wide PACS together with the installation requirements of the major component systems. For the purposes of this guidance, the primary component systems of a PACS are considered to be an RIS and an image management system (IMS).

4.13 This section of the guidance covers the following:

- Introduction
- Challenges in the communication of digital data in the area of PACS – a brief overview of the data communication challenges in the area of PACS
- Benefits and disadvantages of PACS – background information
- Planning considerations when undertaking a hospital-wide PACS project – design implications together

with a suggested project plan, broken down into steps

- Overview of PACS and its implications for the design of the built environment – design and implementation challenges common to each component system of a hospital-wide PACS
- Network technologies and installation – high-speed data transmission networks, the technical elements of distributed data networking in diagnostic imaging departments, together with the built-environment implications
- Radiology information systems (RIS) – the use of RIS to manage; written patient radiological records, accept requests for examinations, and schedule patients' appointments
- Image management systems (IMS) – the use of an IMS in archiving and communication of diagnostic images between the modalities, archives, workstations etc and an HIS
- Overview of PACS implementation outside radiology facilities – the impact of PACS on hospital design.

Intended audience

4.14 This section is aimed at a broad range of hospital staff but may be particularly relevant to the following, who may be instrumental in the configuration of a hospital-wide PACS. The list below is in no particular order:

- the broad range of estates professionals, as listed in Volume 1 of this guidance;
- IT managers and professionals who are concerned with the installation, testing and interfacing of hospital-wide networks and multiple multimedia information systems;
- superintendent and senior radiographers who may be re-engineering working practices, workflows and procedures following the introduction of PACS;
- radiologists and clinicians in hospitals where PACS is being planned or used.

Policies, frameworks and guidance on PACS

4.15 The implementation of PACS should be part of a hospital's overall plan to provide integrated electronic patient records, and should be structured as part of this strategic initiative. The Information Policy Group (IPG) has published a strategy for implementing electronic health and patient records across the NHS by 2005 entitled 'Information for Health – An information Strategy for Health 1998–2005'. A copy of this publication can be downloaded at <http://www.doh.gov.uk/ipu/strategy>.

4.16 Guidance and further information on PACS can also be obtained from the following organisations:

- Royal College of Radiologists (RCR), <http://www.rcr.ac.uk>. Documents and guidance are available with respect to the delivery of radiological services. At least two are concerned with the installation of PACS: 'A Guide to Information Technology in Radiology, Teleradiology and PACS – Second Edition' and 'Radiology Information Systems Board of Faculty of Clinical Radiology';
- British Institute of Radiology (BIR), <http://www.bir.org.uk>. The BIR has formed a committee of experts to look at PACS and is about to publish guidance on the configuration of PACS to provide high-quality radiological services;
- PACSnet, <http://www.pacsnet.org.uk>. This group has recently been set up by the Medical Devices Agency (MDA) to provide advice and guidance on the technical aspects of PACS and equipment. It is also working with the NHS Purchasing and Supply Agency (PaSA), <http://www.pasa.doh.gov.uk>, in the development of a standard questionnaire to aid in the creation of the tender documents for the procurement of PACS;
- the American College of Radiologists (ACR), <http://www.acr.org>, is mainly aimed at radiology professionals working in the USA. However, it has a lot of background information which will almost certainly be of use in developing a PACS within the UK.

CHALLENGES IN THE COMMUNICATION OF DIGITAL DATA

4.17 To allow effective communication between modalities, archives, workstations and other units, the ACR, National Electrical Manufacturers Association (NEMA) and the National Institute of Health (NIH) have drawn up a list of agreed standards. The principal standards are:

- Digital Imaging and Communication in Medicine (DICOM), also known as ACR-NEMA-3, which is primarily used for the communication of radiological images and studies;
- Health Level 7 (HL7), which is used for the transfer of information such as pathology and radiology reports.

4.18 In addition, HL7 and DICOM have been designed to include a number of common elements, or record fields, that allow for the communication of patient demographics between, for example, an HIS and a PACS. The DICOM standard is broken into different parts. These, in the main, relate directly to the type of modality, such as CT, ultrasound and MRI. A full

explanation of the DICOM standard is available from <http://medical.nema.org>.

4.19 HL7 has become the accepted worldwide standard for the communication of text-based patient data and is widely applied in the European Union (EU), the USA and Japan, but not in the UK. It appears therefore that PACS, incorporating the use of HL7, is probably the most adaptable, flexible and supportable of technologies to meet existing and future needs.

4.20 Legacy diagnostic imaging equipment may not be able to generate data directly in a digital DICOM or HL7 format. Interface devices can be purchased to overcome this problem and, where appropriate, reformat the data to a PACS-compatible DICOM standard. Such devices are relatively compact and maybe incorporated into the modality control console or as a small separate unit within the control area.

4.21 A number of manufacturers have incorporated DICOM and HL7 interfaces into the equipment they supply. In theory, this should allow for two devices conforming to the same parts of the DICOM standard to correctly read the data transferred between them, once they have been installed and connected to a network. In practice, however, manufacturers have interpreted the standards in slightly different ways, leading to formatting and communication problems. This presents the major challenge in implementing PACS on a wider scale than just within a hospital.

4.22 To provide a solution to this challenge, the Healthcare Information and Management Systems Society (HIMSS) and the Radiological Society of North America (RSNA) have launched "Integrating the Healthcare Enterprise" (IHE). The primary aim of this initiative is to promote the integration of healthcare information and management systems and to develop a means of communicating medical information effectively and efficiently through multiple IT systems such as PACS, RIS and HIS. The initiative still makes use of the DICOM and HL7 standards, but the emphasis has now changed from the implementation of radiology equipment and IT systems to the use of IT to support good patient care, efficient workflow and a seamless environment for the distribution of medical information. IHE concepts will not only be applicable to radiology but should also be used in other clinical and administration departments. Further information on IHE, together with technical standards and PowerPoint presentations, can be found at <http://www.rsna.org/ihe>. All new equipment procured as part of a PACS project should meet IHE standards.

4.23 Although American-based, IHE is likely to have a greater impact in Europe where there is far greater use of multi-vendor IT solutions. IHE will most likely be

important to the NHS in achieving its own goals of creating full electronic health and patient records.

BENEFITS AND DISADVANTAGES OF PACS – BACKGROUND INFORMATION

4.24 Some of the potential advantages and disadvantages of PACS are described below.

Potential benefits

4.25 The introduction of PACS should enable a number of benefits in patient care in terms of better use and access to radiological information. An example of a potential benefit, relating to attendance at orthopaedic out-patient clinics, has been described previously in [paragraph 4.10](#).

4.26 A number of studies have shown the potential economic benefits of PACS in replacing the use of conventional film and chemistry. For example, Chunn et al (1998) compared the costs of storing images on film with the costs of storing images on optical and magnetic media. The study showed that the cost of producing and storing images on film was approximately \$10 per megabyte of information, whereas for optical and magnetic media this ranged between \$1 and \$5 per megabyte depending on the type utilised. The costs associated with optical and magnetic media have reduced still further since this article was published, whereas the price of X-ray film has increased in line with inflation.

4.27 Clinicians, particularly house officers, can reduce the amount of time spent in searching for a patient's old films and reports in film libraries and stand-alone computer systems. In a study undertaken by Bryan et al (1999), the amount of time clinicians (for example junior hospital doctors) spent locating films for out-patient clinics and ward rounds was assessed. Following the introduction of PACS, the amount of time spent on this activity by this group of staff fell from almost two hours per ward round/out-patient clinic to 40 minutes or less. This hidden benefit of PACS could be helpful in ensuring that hospitals meet government targets on doctors' working hours.

4.28 The film storage space saved by introducing PACS within an existing diagnostic imaging department should become available for other imaging modalities, activities or departments. In some cases the film storage space may be as large as 10–15% of the total radiology departmental area. PACS can also provide a solution to film storage where the hospital has no more storage space available and remote solutions are costly and potentially uneconomic.

4.29 The introduction of a PACS system should reduce film loss rates, or even make such losses a thing of the past. It should also improve the availability of films to

clinicians and radiologists. In the same study by Bryan et al (1999), the unavailability of films to clinicians prior to ward rounds/clinics was assessed before and after the introduction of PACS. The findings showed an overall reduction in the unavailability of films to clinicians and radiologists following full use and integration of digital technologies into hospital clinical practices and workflows.

4.30 The use of PACS should help reduce the number of diagnostic studies that are unreported by radiologists in the department. PACS should improve auditing procedures and highlight any deficiencies that may exist in this area.

4.31 In many hospitals without PACS, it is likely that between 10 and 20% of films may be unreported due to the intrinsic inefficiency of the non-PACS environment. The availability of these films for reporting when PACS is installed will represent a significant increase in workload for radiology and secretarial staff, and should be considered in the business case. This is particularly important as the Ionising Radiation (Medical Exposures) Regulations 2000 state that all exposures should receive a written report. The introduction of PACS will ensure that this is readily auditable by both internal and external assessors.

4.32 Because fewer film-based images will be lost, fewer replacement images will be needed. This reduces associated costs, staff time and patients' exposure to ionising radiation.

Disadvantages

4.33 One of the principal disadvantages of PACS relates to the high level of initial investment. This includes the need for a very strong hospital or institution data network, the availability of the appropriate infrastructure, and the provision of retraining for all staff groups. Project teams implementing the system will need to ensure that training is provided to each staff member.

4.34 Attention should be paid to the relatively high maintenance and upgrading costs associated with these computer systems. These costs will routinely amount to 10–12% per annum of the original procurement cost.

4.35 However, some of the expenditure needed for PACS can be directly offset against the reduction in the use of film, developing chemicals, paper and storage space. Improvements in staff working practices, such as the reduction in reporting times achieved by faster image distribution and the use of better reporting methods, could also be offset against upgrading and maintenance costs (Maass M, Kosonen M and Korman M, 2001).

4.36 PaSA and PACSnet are currently developing guidance for effective contractual arrangements which

could be particularly helpful in this area. The use of PFI (leasing) and PPP mechanisms may spread the initial capital outlay and can ensure that the computer systems are updated and upgraded on a regular basis (Procurement of Information Solutions Effectively (POISE), 2002).

PLANNING CONSIDERATIONS WHEN UNDERTAKING A HOSPITAL-WIDE PACS PROJECT

Overview of operational requirements for the effective implementation of PACS

4.37 The design and specifications for a PACS should complement and work with other current hospital IT developments and will be highly dependent on the operational requirements and policies of the hospital, its staff and patients. PACS should be seen as a technology that enables the improvement of strong working practices, increases efficiency and provides better clinical care. PACS is not, however, a means of improving weak working practices and procedures. Where these exist, it is likely that PACS will highlight deficiencies and possibly have a detrimental rather than positive effect.

4.38 Before commencing a PACS project, a full operational analysis is advised to review the movement of radiological information throughout the hospital, not only within the diagnostic imaging department but also to other internal and external sources. This will highlight any deficits and examine areas where PACS may provide working and “information-flow” efficiencies. For example, PACS may be expected to streamline and accelerate the work sequence for clinicians reviewing orthopaedic out-patients when clinical consultation is followed by a radiological examination, image reporting and then a further clinical consultation. It may also reduce the number of times a patient attends the hospital, to just one occasion for both parts of the consultation together with the radiological examination. It should also be possible to ensure that all the radiological information required by the clinician is available at the time of the patient’s appointment. This has obvious patient-care benefits and allows the clinical team to examine patients more effectively and efficiently.

4.39 Where problems occur with the information flow using conventional film and paper techniques, operational procedures should be redesigned and strengthened to make them as efficient as possible within the existing technologies. These changes should be implemented before the installation of PACS.

4.40 The operational analysis may be expected to form an important part of the specification package to be used in the procurement and commissioning of the PACS. It should also be used to form a project plan

such as the strategy suggested in paragraphs 4.57–4.66.

General aspects of space planning for PACS

4.41 Whilst full details of installation are described in this document, there will still be a need for clear co-ordination with consulting architects, since PACS may be expected to have a significant impact on the design of the built environment. In addition to the elimination of most conventional film storage requirements, PACS will also have a significant impact on workflow in the diagnostic imaging department, and the built environment should be designed to be adaptable and flexible enough to support these changes in working practices.

4.42 In overall terms, the implementation of PACS should achieve a number of efficiencies in overall staff movement and information management. In new departments the decision to incorporate PACS should be integral to the overall department design and should make full use of the opportunities offered by digital technologies. In older departments, changes may need to be made to the fabric and design of the department.

4.43 Computed radiography (CR) or direct radiography (DR) technologies will be needed for a department to move to a full PACS environment. As described in Volume 1 of this guidance, the use of CR may require space allocated to processing areas to be as large as or larger than those required for conventional film processing. However, environmental requirements will be fewer.

4.44 DR is still an emerging technology with very few examples installed in the UK. Space and planning implications for DR include larger general X-ray control areas and, possibly, smaller processing areas. For some radiographic examinations, the use of CR is likely to continue in conjunction with DR and therefore a processing area will still be required.

4.45 Space requirements and layouts of reporting areas will be significantly altered. The facilities to support soft-copy reporting (that is, reporting from image display monitors) will be needed. This includes deeper worktops and generally increased work areas, as described in Volume 1 of this guidance.

4.46 The use of voice recognition technologies has now become a standard feature of electronic radiology reporting systems, and consideration needs to be given to the layout of the reporting workstations and the use of acoustic shielding. The introduction of voice recognition technologies should reduce space requirements for secretarial support staff, who may need to be redeployed into other areas of the hospital.

4.47 The need for areas dedicated to the storage, collation and distribution of patients' written records and films should be largely eliminated by the introduction of PACS. Some space should still be maintained for handling a small number of hard-copy films generated by other hospitals or modalities and when PACS is closed down for routine maintenance.

4.48 Specialist space should be allocated for the storage of image archive servers and other technologies associated with the PACS. Additional space may have to be created, or found, within the department for installation of these devices.

4.49 Relatively small areas will be needed to accommodate both core and satellite hub units forming part of the PACS data network. These are described in more detail in [paragraphs 4.152–4.167](#).

4.50 Clinical seminar rooms will need to be designed or adapted to accommodate digital technologies, such as a large number of PACS-linked image display monitors and digital projection equipment. The size of seminar rooms will be similar to that required in a film-based department, but additional secure equipment storage space will be required, as described in Volume 1 of this guidance. A plan demonstrating this type of space is included in [Appendix 1](#).

Multidisciplinary project teams

4.51 A broad, multidisciplinary project team is required to support the introduction of PACS throughout a trust and this should include representatives from departments outside of radiology specialties, in particular by estates and IT staff. It is also advised that representatives from local primary care trusts be consulted when constructing the full business case.

4.52 The estates team will need to co-ordinate the impact of the new technologies on the design of the hospital and make phased modifications to building structure where these are required. The electrical supply and earthing infrastructure will need to support the new technology and should also be considered at each stage of the project.

4.53 The IT team is likely to co-ordinate the PACS implementation project and will therefore have an instrumental role in linking the system in radiology to any existing or concurrently developing HIS.

4.54 The introduction of PACS will have an impact on the design of all departments throughout new or existing hospitals and this will need to be considered by local project teams and contracted architects.

PFI/PPP opportunities in the design planning for PACS

4.55 Where PFI/PPP mechanisms are used in procuring PACS for the first time, the costs for updating the design of the buildings and the provision of the facilities could be integrated into the agreement with suppliers.

4.56 This agreement may also include financial allowances for periodic upgrades and modifications to the buildings in conjunction with updates to the PACS system during the serviced contract period. If such mechanisms are supported by the agreement, this should allow for major changes in the design of facilities every five years, with some minor improvements made every 2.5 years. This is consistent with observed development cycles in PACS and IT.

Suggested project planning and phasing

4.57 A plan should be established at the beginning of the project and this should include time allocated to the design, adaptation and construction of new equipment and facilities. Changes to the building fabric may be necessary to allow for alterations in workflow throughout the whole hospital arising from the introduction of digital imaging techniques and new operational practices. The cableways serving each item of equipment and the spaces in which the items are installed also need to be considered in the early planning stages. This is so that the units can achieve optimum working efficiency and maximise the time between device failures caused by poor operating environments.

4.58 An example phasing structure for a hospital constructing a hospital-wide PACS system is outlined in [paragraphs 4.62–4.66](#). While it may appear attractive to move to a full hospital-wide PACS as a single project, particularly when changing from a film-based system, it may be advisable to break the project down into smaller, achievable steps. The suggested project plan is based around the assumption that an existing department is using plain film for the acquisition of general X-ray images, coupled with a mixture of part- and fully-digital approaches for image acquisition for other modalities.

4.59 The time allocated to the implementation of a PACS should be carefully considered at the beginning of the project, be based on local circumstances, and take into account the following factors:

- the age of the hospital – installing and operating PACS in older buildings may prove more difficult;
- the specification of the existing digital communication infrastructure for the distribution of medical information and the potential requirements for upgrading;

- the increased operational costs and risks of running both digital and conventional systems in parallel;
- the ability of staff to accommodate changes in operational practices and workflows;
- the availability of hospital staff to train to use the PACS.

4.60 Below is an indication of the steps involved in the installation of PACS (including a dedicated radiology-based high-speed network). Each site will have different operational requirements, infrastructure and equipment. These will influence the overall phasing and scope of the PACS procurement project.

4.61 The component systems described under each step should be separately tested and commissioned at the appropriate stage before moving forward and introducing them into a clinical service. It is advised that an evaluation is undertaken following the completion of each step and any lessons learned are taken forward to the next stage. Following completion of the project, time may be allocated to test the system before it is brought into full clinical and operational use. It is likely that problems will become apparent on the integration of the component systems, and these will require attention before the system is used routinely (Reed G and Smith EM, 2001).

Suggested steps for the implementation of a PACS

Step 1

4.62 Assess the changes in spacing requirements to support the implementation of a PACS and plan them in detail.

Step 2

4.63 Design, procure and install the network (see [paragraphs 4.133–4.167](#) on network technologies and installation):

- if a hospital network does not have sufficient capacity to support the high data loads generated by full-quality, uncompressed radiological images, a separate dedicated network will need to be installed in the radiology department. This will support the movement of data between workstations, archives and modalities. Additional dedicated connections may be required between the PACS network and other departments such as A&E, orthopaedics, intensive therapy units (ITU) and other areas with significant requirements for access to full-quality diagnostic images (such areas may be referred to as “high-end users”);
- the software on each of the modalities and existing imaging workstations should be updated to include

DICOM and HL7 communication modules. It is advised that exact requirements should be specified in consultation with the suppliers and/or manufacturers of the equipment and with the MDA/PACSnet where there may be issues of conflict and misinterpretation;

- the Ethernet interfaces for each of the modalities/workstations should be updated to 100 BaseT/Gb standards as and where required. A virtual local area network (V-LAN) controller should be provided as a means of routing electronic information, maintaining network speed during failures and providing security for the network. An outline description of a V-LAN controller is provided in the Glossary;
- a resilient, V-LAN-controlled, distributed topology fibre-optic core network for DICOM communications within the radiology environment should be designed, specified, procured and implemented. This should be a high-bandwidth system and in addition to any hospital network infrastructure. Such an arrangement may be required to protect the general hospital network environment against excessive and unnecessary demands caused by the high data loads generated in radiology,
- at the design stage of network procurement and implementation of the built environment, implications for the radiology network should be assessed and space allocated for the main and local hub units, together with the V-LAN controller. The fabric of the building must be designed or assessed to check that it is able to support the installation of network links or cables, including access for maintenance and expansion;
- it is likely that the overall design of the network will utilise a mixture of fibre-optic and unshielded twisted pair cables (UTP), such as Category 5 cables commonly used for standard data and voice communication. The built-environment implications of networking are further described in the ‘Network technologies and installation’ section ([paragraphs 4.133–4.167](#)).

Step 3

4.64 Procure the RIS:

- the existing RIS may need to be updated or replaced and this should include a patient scheduling system. It must be possible to interface the RIS with both HIS and the IMS. Interfaces between the HIS and the RIS will be needed to ensure coherence between the separate databases and provide servers with bi-directional communications between the different systems;

- new or replacement RIS workstations may need to be provided throughout the radiology department. These will be simple PC workstations. Installation should only be undertaken in consultation with the supplier or original equipment manufacturer;
- RIS interfaces should be provided for each of the capable imaging modalities to allow the selection of patients using HL7 or DICOM work-lists;
- space should be provided in another building of the hospital for an additional computer workstation, which will hold a back-up copy of all the RIS data. This will provide access to the main data in the event of fire or another major failure affecting the core system.

Step 4

4.65 Procure the CR/DR system:

- the facilities of the department should be adapted for the utilisation of CR and/or DR instead of conventional film radiography and processing. The built-environment implications for CR and DR are described in Volume 1 of this guidance;
- multiple CR facilities should be specified, tendered and procured – including plate readers, associated image manipulation and review workstations, networking segments, training etc. The use of multiple small CR units is advised rather than a single large unit, as this gives protection against a single point of failure;
- new CR/DR systems in the department, together with associated user interface terminals and image manipulation workstations, should be installed and commissioned;
- CR/DR segment/systems and RIS should be provided and installed and the interface tested;
- the laser printing facilities should be updated to allow for dry laser printing from the CR/DR systems and other imaging modalities. This will be a small-scale activity following PACS implementation but cannot be omitted, as film-based services will continue to be required for non-digital clinical radiology users, back-up purposes, and before the IMS is installed and commissioned;
- the majority of current conventional processing equipment should be decommissioned, and plain film acquisition transferred to CR. Decommissioned items will include all the major components associated with plain film acquisition (such as chemical mixers), any wall-mounted equipment, daylight processing units etc. Some conventional processing equipment may still be needed to process the specialised films in areas such as mammography and dentistry.

Step 5

4.66 Procure the IMS:

- facilities should be adapted for the installation of the IMS. This will include image archives, computer servers and other associated systems. Space in another building, possibly outside the main hospital site, should be identified for the installation of an additional single, low power (large capacity, slow retrieval rate) archive. This will act as back-up in the event of fire or another disaster that results in all the images on the main servers being lost;
- computer systems that are currently installed on wards and other areas of the hospital should be updated to allow them to receive radiological images. In some cases, additional computer workstations may be required. The environment in which the units are installed should be carefully considered;
- new IMS and associated image archives and servers should be specified, put out to tender and procured;
- facilities for the installation of the new computer systems should be adapted or built. The built-environment requirements for the servers etc are described below under “Image management systems” (paragraphs 4.192–4.236);
- the new IMS, including computer servers, archives and cabling, should be installed, commissioned and tested;
- radiologists’ computer workstations should be upgraded to enable basic image display and manipulation and to support digital reporting activities, as described above in paragraphs 4.41–4.50 and in Volume 1 of this guidance;
- additional modality image manipulation workstations should be procured and installed as appropriate. Additional space and, possibly, separate offices may be needed for these units;
- image display facilities, for use in clinical seminar rooms and libraries, should be specified, tendered, procured and installed. This may include large-scale monitors and overhead digital projection equipment. One or more such seminar rooms may be required, depending on policies and space availability;
- the V-LAN controller should be configured to take into account the new IMS;
- a web-based export database should be procured and connected to the main hospital network for the transmission of images and reports. This may be undertaken as part of the procurement for the IMS. The images distributed by the export database will not be of sufficient quality to allow for radiological

reporting but will be suitable for review purposes only;

- the RIS and IMS patient databases can then be merged, if required;
- existing digital data should be re-used or transferred from the archives to the main storage devices within the PACS. Such existing digital data may typically include CT or MRI images held on CD-ROM. The images on these archives should be transferred, where required, using methods described in paragraphs 4.106–4.112;
- a new digitiser should be procured, or an existing one upgraded, and connected to the main radiology network;
- following extensive testing, PACS should go live;
- digitisation of selected films from existing archive should commence as they are requested by clinicians and radiologists.

OVERVIEW OF PACS AND ITS IMPLICATIONS FOR THE DESIGN OF THE BUILT ENVIRONMENT

Introduction

4.67 In the short term it is hoped that integrating the data flow between PACS, RIS and HIS will reduce the number of steps required to obtain and interpret radiological examinations. For example, it is estimated that 32 steps are required to order, obtain and then report an ultrasound examination using a traditional paper/film-based system. Using a fully integrated HIS/RIS/IMS digital system, this could be reduced to just nine steps, whilst also cutting down on the number of manual data entries required. This minimises the introduction of errors onto patients' records and database fractionation, which would all have to be corrected manually.

4.68 Hospitals should therefore be redesigned and structurally altered to incorporate the greater use of electronic, disk-based archives, servers and high-speed networks for the storage and distribution of patients' records to all areas of the hospital. Clinical staff will need to access patient data. Requirements for widespread availability and use of computer workstations will therefore become common in virtually all departments and wards.

4.69 There will also be significant changes to staff workflows, as these will be affected by changes to the operational requirements following the introduction of the new IT systems. The design of the built environment should be tailored to maximise staff efficiencies by enabling the use of the new IT systems.

4.70 Other considerations include early planning of data-cabling networks and the provision of dedicated spaces for core hubs, archives and servers, along with appropriate environmental systems and staff accommodation. There will also be changes in the way spaces are used, not only in the radiology department but throughout the hospital. These issues are discussed below.

Effects of transition phase on the design of the built environment

4.71 Before the installation of the digital archives, servers and hubs, the space requirements should be carefully evaluated with potential vendors. All potential options for the transitional move from conventional techniques to a fully digital environment should also be explored. This should include an appraisal of outsourcing the storage of film and images to specialist contractors. It is unlikely that a hospital will be able to transfer all the radiological work onto digital format in a short space of time using a conventional system, even following the installation of all the component systems.

4.72 In the majority of cases there will be some challenges in the commissioning and early use of a PACS system which may require the department to continue to use either part-digital or full-conventional approaches for a short period following installation. In addition, the initial installation of the PACS may not cover all the sites and departments undertaking radiological examinations within a hospital and therefore some diagnostic images may still continue to be recorded onto film.

4.73 Radiologists and other clinicians will almost certainly require continued and relatively easy access to some of the older images on film. This may be for reviewing records of patients with chronic conditions, for teaching or research purposes, or for use in multidisciplinary case conferences.

4.74 The hospital may therefore have to pass through a transitional phase when moving from a film-based to a full-digital system, requiring facilities to support both approaches.

4.75 For example, film storage and distribution facilities, as described in Volume 1 of this guidance, may still be needed. This is to collate, store and distribute medical images together with printing devices which allow the reproduction of films from MRI scanners etc in hard-copy format.

4.76 In addition, a conventional film processor and the chemical mixers required to produce hard-copy films may need to be maintained during the transitional period and possibly in the early stages of PACS implementation. This may be required as a back-up to

the CR/DR facilities and to allow the department to produce plain film radiographs if the PACS system fails in the early stages. The continued use of film processing equipment to undertake general radiography will depend on the operational policies of the trust and the need to have any redundancy in the system.

4.77 Therefore, for a temporary period, the processing and viewing area may need to accommodate both CR units and conventional processing units, and additional space may need to be identified to meet this requirement. In some instances, this may mean that temporary spaces, adjacent to but outside the main processing area, may have to be used to accommodate the additional equipment.

4.78 Every effort should be made to ensure that this transition period does not exceed six months. A greater period than this will stretch the existing staffing resources and provide additional pressures in the main diagnostic imaging and interventional radiology department. It may also prove difficult to maintain both sets of facilities.

4.79 It is improbable that space formerly allocated for film storage, sorting and collating will be suitable for the digital archive and other equipment required to configure the PACS. Space may have to be identified and adapted for the permanent location of the computer servers, digital archives and hub rooms associated with the IMS and RIS.

4.80 The core and local hub units should be installed in the main department, as these form the backbone of the high-speed PACS network. Additional space within or adjacent to the department will therefore have to be found for their installation.

4.81 When installing the digital servers and archives, a few options are available, and these are described in paragraph 4.82. In each instance the trust should evaluate which is the most suitable option in economic and space-planning terms and make an early decision, as this will have substantial consequences on the redesign of the department.

4.82 Options for the installation of digital servers and archives are as follows:

- the digital archives and server units should be located within, or as close as possible to, the main radiology department. This gives professional staff groups working in the department good access to the archives and servers. Staff are therefore able to undertake simple first-line maintenance or easily retrieve data stored offline. Although this is the recommended option, it has the disadvantage that additional space may have to be found for the location of the archives and servers. In some

instances, space that was allocated for sorting and collating films could be utilised for the installation of the equipment. This is provided that temporary space can still be created within the department for this function, as this process will still need to continue during the transitional period and, possibly, following the full introduction of PACS;

- if a high-speed network connection can be provided between the radiology department system in radiology and the servers, archives etc, and the chosen location meets the environmental and access standards detailed in this document, theoretically the archive and servers can be installed within any part of the hospital. This has the disadvantage of poor access to the archives and servers for people working in radiology, but the advantage that there is usually flexibility in the provision of space for these systems;
- following the run-down period, existing rooms allocated for film storage and distribution can be re-used for other purposes such as the installation of a general X-ray room or CT scanner;
- if space within the hospital is limited, or allocated for other clinical purposes, a solution may be to store most of the films on an external site and use the space saved from the film store for the installation of the new technology. This has the advantage that the digital archives can be installed close to the main department without additional space having to be found. The main disadvantages are the expense of remote storage and potential delays in record retrieval;
- consideration may be given to maintaining the main digital archives and servers on a remote site as a permanent, cost-effective solution to the digital storage of medical images. This could be undertaken by a specialist company or managed internally using existing trust IT resources.

4.83 This method of storing images is beginning to gain some popularity in the USA where a number of companies now provide a service to hospitals and other institutions, but no examples currently exist within either the NHS or the independent healthcare sector. However, such “data-warehousing” solutions are commonly offered to private companies within the UK and could theoretically be used for healthcare purposes.

4.84 Following the transitional phase, and even following the introduction of full PACS systems, it is advised that a small amount of space still be allocated to:

- store films received from other hospitals;
- store films created during periods of major system downtime;

- keep some films that may be required for teaching or research purposes.

Integration with full HIS and patient information systems

IT aspects of hospital-wide image distribution

4.85 As a means of providing images and patient data to other hospital departments, a PACS export server may be incorporated into the overall system design.

4.86 The PACS export server will receive electronic requests from clinicians in departments outside radiology and communicate with the main PACS servers and archives to acquire the appropriate information. The export server may compress or convert the image data into a format which can be read by a web browser and combine this with the radiological reports. The information is then sent, using the hospital network, to the requesting clinician who will view the information on a PC. This approach has the advantage of allowing the images to be easily distributed using existing hospital data networks, which may not support the transmission of full-quality radiological images but nonetheless will be of appropriate quality for the majority of clinical applications. Also, the main server and archive functions will not be constantly interrupted by requests for information outside the main department. In addition, the software to view the images is free and the platform is independent. The primary disadvantage of this approach is that the images distributed are only suitable for review and not for reporting purposes.

4.87 Where high-quality full radiological information is required, specialist data network connections will need to be installed, as described below in paragraphs 4.132–4.167.

Built-environment requirements of hospital-wide image distribution

4.88 In space-planning terms an additional web server will need to be provided and connected, using a high-speed optical connection, to the main PACS system archive and server units. This web server will also need to be connected to the HIS, possibly via the use of a high-speed network connection. The server should be fitted with appropriate electronic firewalls and other physical mechanisms or barriers to prevent unauthorised access to patient data held on the PACS, and infection by computer viruses.

4.89 This PACS export server will most likely be connected to a short-term, high-speed data storage unit, possibly a RAID, which will be used for the temporary caching, or storing, of radiological data. The unit will need to be housed in a computer room accessed by authorised personnel only, as described in paragraphs 4.211 ff. Where possible, this should be a

separate computer room from those used to house the main archives and servers. However, where space limitations exist, these areas can be combined.

4.90 The size of the computer room required will depend on the type of export server procured, and whether a separate RAID archive is used to temporarily store the image data. In the majority of cases, however, a space allocation of between 2.0 x 2.0 m and 2.5 x 2.5 m should be adequate to allow for installation and room for undertaking maintenance procedures.

4.91 The design of the room to support the export server should be similar to the computer rooms described in paragraphs 4.211 ff. In some instances, two computer export servers may be procured for redundancy purposes and to share the workload. The space allocation should be increased accordingly.

4.92 Patient data is confidential, and protection of this information is a legal requirement. Sadly, the theft of PCs from hospitals is an increasing problem, which may have legal implications should the hard drive contain patient records. Accordingly, the use of “thin client” software is recommended, where the patient information is only temporarily stored on the terminal, ensuring that maximum security is maintained.

IT requirements for local, full-quality image distribution

4.93 Where departments other than diagnostic imaging require full-quality images for diagnostic interpretation purposes, or where the information demand is likely to be high (such as A&E and CCU), dedicated network connections may need to be constructed linking them to diagnostic imaging. This is further described in paragraphs 4.133–4.167.

Continued use, or disposal, of conventional imaging equipment following introduction of PACS

4.94 PACS – including the RIS, IMS and network – should be designed with the appropriate redundancy to be theoretically operational for 24 hours a day, seven days a week (excluding planned downtime and upgrades). Clinicians and radiologists will need access to the information held on the PACS archives at all times. Therefore, provided the PACS network is designed with appropriate redundancy and duplication of equipment, there should be no requirement for maintaining the conventional hard-copy film processing systems within the department for the majority of examinations. Exceptions, including possibly mammography or dental imaging, are discussed in paragraphs 4.98–4.103.

Dry laser printers

4.95 There will be a continuing requirement for dry laser printers to produce hard-copy images within the PACS.

These will support the distribution of radiological information in times of planned upgrades and maintenance, and provide film images to other hospitals and clinicians outside the PACS environment. A separate image-printing network may need to be installed between the modalities, some workstations and the dry laser printer or printers to meet this requirement. The dry laser printers should be installed in the processing area for maximum accessibility. Consideration should be given to providing more than one unit for redundancy purposes. The installation requirements for dry laser printers and associated servers are described in Volume 1 of this guidance.

4.96 Inkjet printers may also be retained in connection with some modalities as part of the contingency planning measures. Space for these small objects will still need to be allocated within control areas.

4.97 For environmental and installation reasons, continuing use of wet laser printers is not recommended.

Mammography

4.98 The image quality requirements in screening and symptomatic mammography examinations are very high..

4.99 However, staff may take the view that the technology is not yet sufficiently mature and reliable to use in day-to-day clinical mammography practice, and may wish to continue with the use of conventional film processing techniques for a time following the introduction of a PACS. In addition, the conventional processing facilities may also need to be maintained to support mobile vehicle breast screening services.

4.100 Therefore, space within the processing area of the department may still have to be allocated for the processing of conventional mammography films. It is likely that this can be achieved by using a single daylight system, coupled with a chemical mixer and silver recovery unit etc, as described in Volume 1 of this guidance, Chapter 3. It is likely that a darkroom will still need to be maintained so that the mammography film can be stored and film magazines can be reloaded.

4.101 If the throughput of films is low (as may be the case if the equipment is used to process symptomatic mammography examinations), the department will need to ensure that the developing and fixing chemistry remains sufficiently active to support the procedures. It is possible that the developer and fixer replenishment rates will have to be increased to meet this operational requirement.

4.102 However, designers should consider that the move to digital mammography acquisition techniques will eventually take place and the PACS, together with

the departmental design, should be sufficiently flexible to allow for both conventional and digital processing of images.

Dental imaging

4.103 Although digital image processing methods and technologies are available, as described in the dental imaging section, diagnostic images acquired in extra-oral dental X-ray examinations may continue to be processed using conventional techniques. However, there are no clear reasons why PACS should not be extended to all types of dental imaging, other than the potential additional costs involved and the need to process extra-oral dental images acquired in out-patient departments outside the main diagnostic imaging facility.

Disposal of equipment

4.104 Other conventional film processing equipment being replaced by CR or DR will need to be removed from the hospital, and arrangements with either the supplier or disposal company made in advance. All existing developer and fixer solutions will need to be emptied from the units and disposed of appropriately in accordance with the COSHH Regulations. If the equipment has been loaned from a supplier as part of an operating lease, it may need to be re-crated and returned.

Processing space implications

4.105 The space previously allocated in the processing/viewing area for conventional film processing equipment could be used for the installation of equipment connected with the PACS project, such as the CR plate readers and associated workstations, as described in Volume 1 of this guidance. Additional space will be required to accommodate large image quality review monitors and CR processing equipment. Space will probably not be saved in the processing area following the transition to a full PACS unless the trust makes full use of existing and new DR technologies, which do not require a second processing step.

Utilisation and gradual “run-down” of existing film storage facilities

4.106 It is unlikely that it will be possible to bulk-digitise the whole of the existing hospital film library. It is estimated that to transfer approximately five years' worth of film from a DGH acquiring 100,000 films per annum would take approximately ten man-years. A significant amount of space would also be taken up on the new digital archive by images that have demonstrably little or no value. The allocation of space to multiple digitisers to undertake this task within either the hospital or diagnostic imaging department is therefore not advised.

4.107 An alternative, less labour-intensive, approach would be to digitise only those hard-copy films that are requested for further review following a patient's repeat attendance in a hospital, or those that are allocated as examples for teaching purposes. These could then be added to the digital archive and stored on the IMS for the accumulation of radiological images.

4.108 To facilitate this recommended transitional approach, space should be allocated for the installation of one, or possibly more, digitisers and image manipulation workstations in a separate room. The number of systems required will depend on local assessment of the existing film archives.

4.109 Following the transition phase a single digitiser, possibly within the same room, should be sufficient to meet the needs of the hospital. Continued use of this digitiser will be necessary to digitise hard-copy images that have not originated from a PACS-based diagnostic imaging department or that have been acquired using conventional imaging approaches.

4.110 Provided the digitiser has been procured to a high enough specification (40 micron resolution and linear 12-bit storage depth) it can also be used in the digitisation of mammography films for primary storage and reporting purposes.

4.111 Space and environmental requirements for digitisers have been indicated in Volume 1 of this guidance.

4.112 At some stage it is likely that there will be a considerable amount of X-ray film that will have to be disposed of safely, with respect to patient confidentiality and following the COSHH Regulations. Silver recovery undertaken by specialist firms may provide an option to recover some costs.

CD-ROM based archives from modalities such as CT or MRI

4.113 These can simply be transferred from the CD to the PACS via a specialised review workstation, such as a cross-sectional workstation, fitted with a CD reader. They may need to be reformatted to the appropriate standard before archiving. The workstation should be networked to facilitate the transfer of data to the archives.

4.114 Non-standard digital-based archives may require specialised readers and reformatting procedures. These may include older modalities such as those which may use Exabyte and other types of tape system.

4.115 There may no longer be a requirement to accommodate a local dry laser printer or CD storage within the control areas associated with CT or MRI, and a small amount space could be saved following the introduction of PACS. Local contingency plans may

require that the modalities are still able to print images or save data to CD if the PACS system fails or is upgraded. Space to support these processes will therefore still be required.

4.116 For example, if a small archive is used to store both CT and MRI images as part of a "mini-PACS", images could be directly transferred to the main archives using the same transfer practices or policies described in paragraphs 4.106–4.112. On completion of this process, the small image archive could be re-used to store images at another site providing radiological services as part of the overall PACS solution. This may also save a small amount of space in these facilities.

4.117 For reasons of patient confidentiality, it is strongly advised that a specialist company dispose of all redundant archiving materials.

Fire precautions – general advice

4.118 Essential equipment considered necessary for the maintenance of the network infrastructure – including core hubs, servers and archives – should be contained within fire-resisting enclosures with at least 60 minutes' fire resistance.

4.119 The archive, server and core hub rooms should also incorporate some form of automatic fire protection system to provide first-line protection against a possible fire. This could be undertaken using local detectors linked to a local piped system with some form of inert gas.

4.120 The use of halon is gradually being phased out for environmental reasons, and some alternatives are suggested in paragraph 4.122.

4.121 The use of water sprinklers is not advised in these areas. In addition, the rooms should be equipped with a carbon dioxide fire extinguisher.

4.122 Alternative solutions to the use of halon systems include the use of gases such as FM200, NAFSIII, argonite and inergen. All of these agents extinguish fires, although they vary in performance and, hence, the concentration of agent required. The gases all have variable toxicities and should be carefully assessed for efficacy and risk where personnel may be subject to exposure to the gas discharge. All claim to be "environmentally friendly" but, again, performance is variable.

Environmental requirements for the siting of PACS/HIS computer workstations

Security issues in the siting of computer workstations

4.123 The risk of theft in a number of areas throughout the hospital should be acknowledged and assessed when installing computer workstations, particularly those

areas that may become accessible to the general public when members of staff are absent (for example outside core working hours).

4.124 Consideration should be given to security marking and physically securing monitors and other computer equipment. Prevention of theft is particularly significant if the computer equipment carries confidential patient notes – for example, workstations used for reporting and processing patients' images and notes. The use of software protocols, passwords, key cards, and biometrics (fingerprint recognition) may prevent sensitive patient data being accessed in the event of theft from the hospital.

4.125 Access to sensitive areas, such as shared reporting rooms and radiologist offices, where there are likely to be computer workstations permanently holding private and confidential patient records, should be controlled by the use of swipe cards or similar devices. For example, the ID badges carried by members of staff could be used to gain access to the areas concerned.

Patient confidentiality

4.126 Where computer monitors used for the viewing of confidential patient information and images are installed in accessible areas, such as nurse bases, the units should be sited so that the data displayed cannot easily be reviewed except by clinical staff. Such computer workstations may only temporarily hold patient data; confidentiality may therefore be further ensured by the use of encryption software, passwords and similar new technologies.

Ergonomic issues

4.127 Consideration should be given to EC health and safety guidance governing the installation of viewing monitors in respect of depth and height of the worktops, together with provision of dimmable glare-free lighting conditions. Low lighting conditions should also be provided so that radiological images may be reviewed appropriately (CIBSE, 1989).

Portable and hand-held computers

4.128 The use of hand-held computers and portable computing devices to review patient data and radiological images is beginning to find some popularity in the UK. It is expected that the use of these units will continue to increase, particularly with the introduction of a greater number of IT systems throughout the NHS.

4.129 Portable units may be used as part of a LAN system or to allow the clinician access to information at the patient's bedside through the use of a simple fixed network interface.

4.130 If W-LAN systems are being used, a full risk assessment should be undertaken before installation, and their effect on medical devices carefully analysed.

4.131 There is no common encryption standard for securing the data transmitted using W-LAN and this may allow other nearby, and possibly unauthorised, users with similar equipment or receivers to access confidential patient information.

4.132 The security of the units when not in use will need to be considered carefully as these devices are likely to be expensive to replace. In addition, they may carry confidential patient information which should be accessed only by trained clinical personnel. As a minimum, a secure store for overnight/out-of-core-hours should be provided and the portable units should be appropriately security marked or labelled.

NETWORK TECHNOLOGIES AND INSTALLATION

Introduction

4.133 A separate communications network may have to be created for the communication of high-quality, high-volume data within the main diagnostic imaging department. This network may have to extend to other high-priority clinical areas such as A&E, cardiology etc to facilitate high standards of patient care.

4.134 This section provides guidance in the technological and built-environment aspects of networking, based on the assumption that a new network will have to be designed and installed "from scratch" as part of the overall PACS project. A separate network segment for the provision of new CR/DR facilities is also described. An example of the network configuration is provided and then described in outline. The built-environment implications of the implementation of a specialist network are then described.

Technical background

4.135 All designs for PACS networks should be based on Ethernet standards of networking as this is currently the primary standard supported by DICOM, HL7 and IHE for the communication of medical information. This technology is also cheaper than other networking approaches commercially available. [Figures 4.1](#) and [4.2](#) show detailed data network design and integration with a hospital-wide system.

4.136 The design of the PACS network should meet the reliability specifications in a distributive strategy by minimising the single points of failure. In this approach, a mixed fibre-optic and unshielded twisted pair (UTP) Cat 5 network should support the full range of Ethernet standards as defined by the American Networking Standards Institution (ANSI).

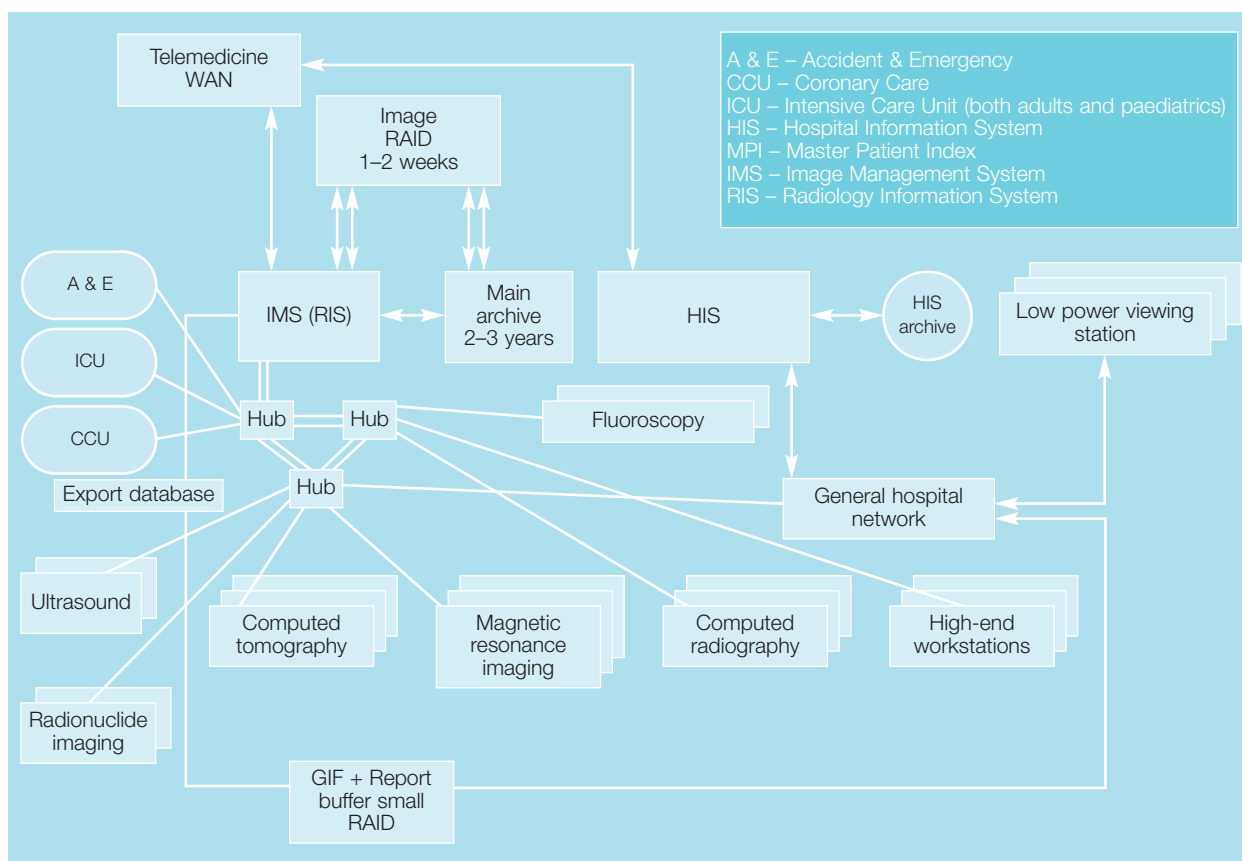

Figure 4.1 Basic conceptual diagram of proposed PACS/RIS and HIS integration

4.137 A triangular network topology (shown in Figure 4.2) is one of the suggested strategies for the provision of a network. Alternative designs using four or more core hub units are acceptable, particularly in larger departments. The use of fewer than three core hub units in a solution is not recommended as this will give inadequate protection against single points of failure.

4.138 In this approach, three or more major hub units (or fast Gigabit Ethernet switches) will form the core nucleus of the network and will be connected either to smaller local hub units, which are in turn linked to multiple devices such as workstations, or directly to the modalities themselves. Fibre-optic cabling between each of the core hub units is usually required to provide the necessary infrastructure and speed to meet the operational requirements. Load-sharing redundant connections should be provided between each local and core hub unit to maximise the reliability and “technology refresh” of the network. For example, Figure 4.2 shows three connections between the core hub units, where two would be used routinely, and the third as a spare link if required. The data load would normally be shared between two of three links.

4.139 Further redundant connections should be built into the design between each of the local hub units and the core hubs so that the data flow is not interrupted if one of the core hub units should completely fail. At all

times it should be possible to move data and information between the image review workstations, modalities and image archives using two of the three core hub units. Examples of this strategy are demonstrated in Figure 4.2.

4.140 All hub units should be provided with sufficient redundant connections together with non-allocated ports and spare slots for further expansion and development.

4.141 The core fast-switching hub units will support a mixture of UTP or fibre-optic connections configured for Ethernet Gigabit, 100 BaseT or 10 BaseT communication standards. As previously described, control of the network will be achieved by using a separate V-LAN controller, located either inside or outside the radiology department. This may be a separate unit installed to meet radiology’s requirements, or the main hospital system serving the entire hospital networks.

4.142 Multiple connections to each of the main image archives and servers should be undertaken using fibre-optic connections to support the Gigabit Ethernet standard for data transmission and communication. This will support the use of fast access speeds to the radiological images.

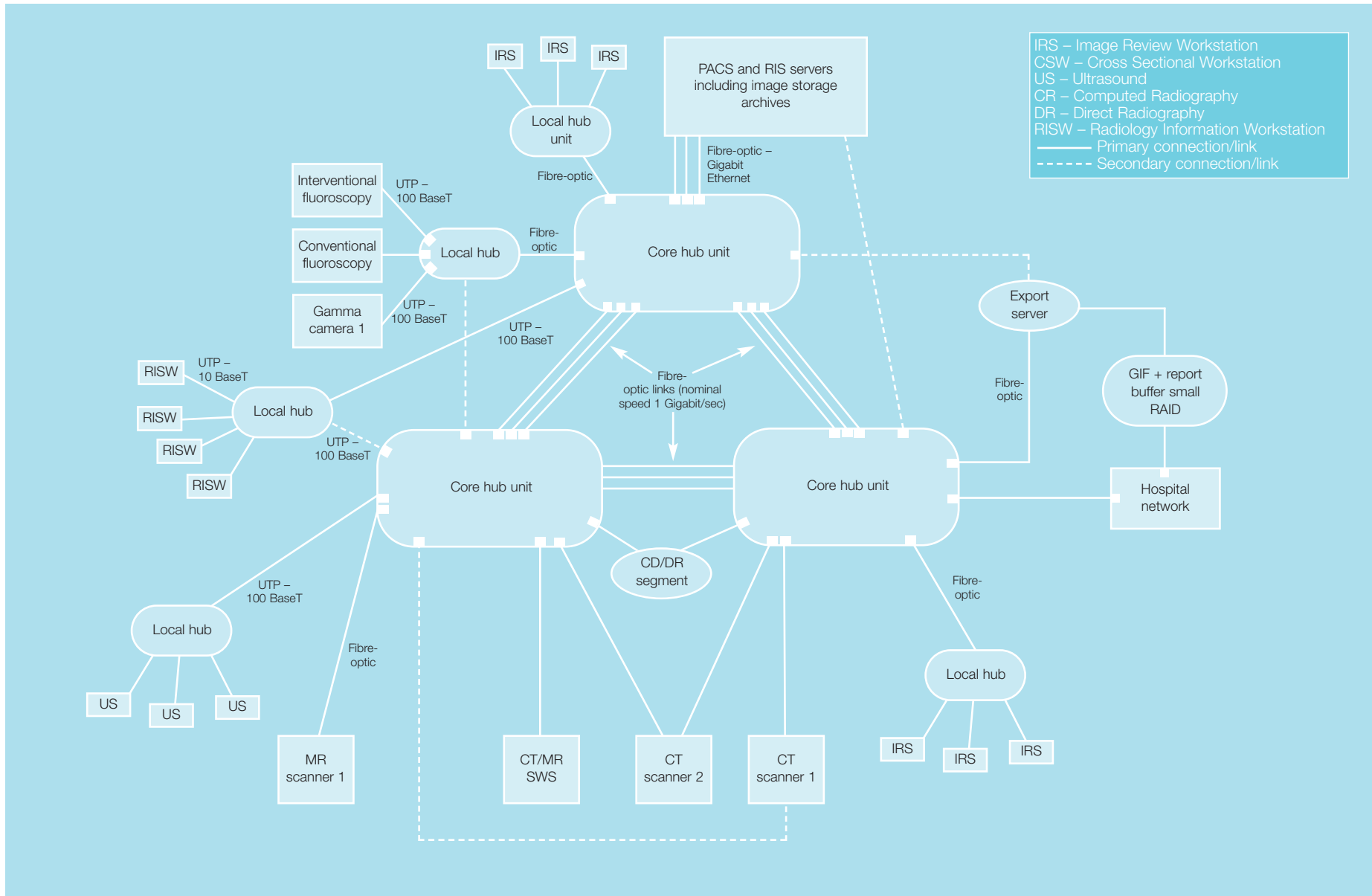

Figure 4.2 Example network designs

4.143 Radiological images will also be transmitted to the radiologists' workstations for reporting and review. This could be undertaken by the use of 100 BaseT Ethernet protocols, supported using UTP or, possibly, fibre-optic connections from local switches or hubs. Several reporting workstations may be connected to a single local hub unit. For redundancy, several local hub units should be used and connected to more than one core hub unit. Again, this is undertaken to protect against single points of failure. This is demonstrated in outline in [Figure 4.2](#).

4.144 The network will also be used in the transmission of radiological reports, patient demographic information etc related to the provision of an RIS. Connections will be needed to dedicated RIS terminals in the department to support these functions. The use of low-speed 10 BaseT Ethernet UTP connections is usually required in this instance, with multiple workstations connected to local Ethernet hubs.

4.145 The PACS/RIS section of the main radiology system should be self-contained and communicate with the main hospital network using two separate connections, as described in [Figure 4.2](#). In some cases there is a requirement to keep the high-quality DICOM radiological data within the radiology network so as not to overload the HIS.

4.146 The radiology network may need to include dedicated fibre-optic or UTP network connections to departments such as A&E, cardiology and both adult and paediatric intensive care units. These connections may be seen as pivotal in meeting the operational requirements, particularly if imaging modalities and review workstations are installed in these departments. A similar, further connection may be required to a radiotherapy centre for imaging applications supporting modern treatment planning and protocols.

4.147 A separate network segment should be constructed to support the procurement and installation of multiple CR or DR X-ray units. This will be required because the workloads associated with general X-ray images and consequential information volumes will be much higher than those in other areas of the department. This network should make use of two of the core hub units or switches. An example implementation for a four-system CR (plate readers, ID terminals and workstations) segment is shown in [Figure 4.3](#).

Cabling aspects of installation and explanation of terms

4.148 The following Ethernet standards are commonly referred to in the design of a PACS:

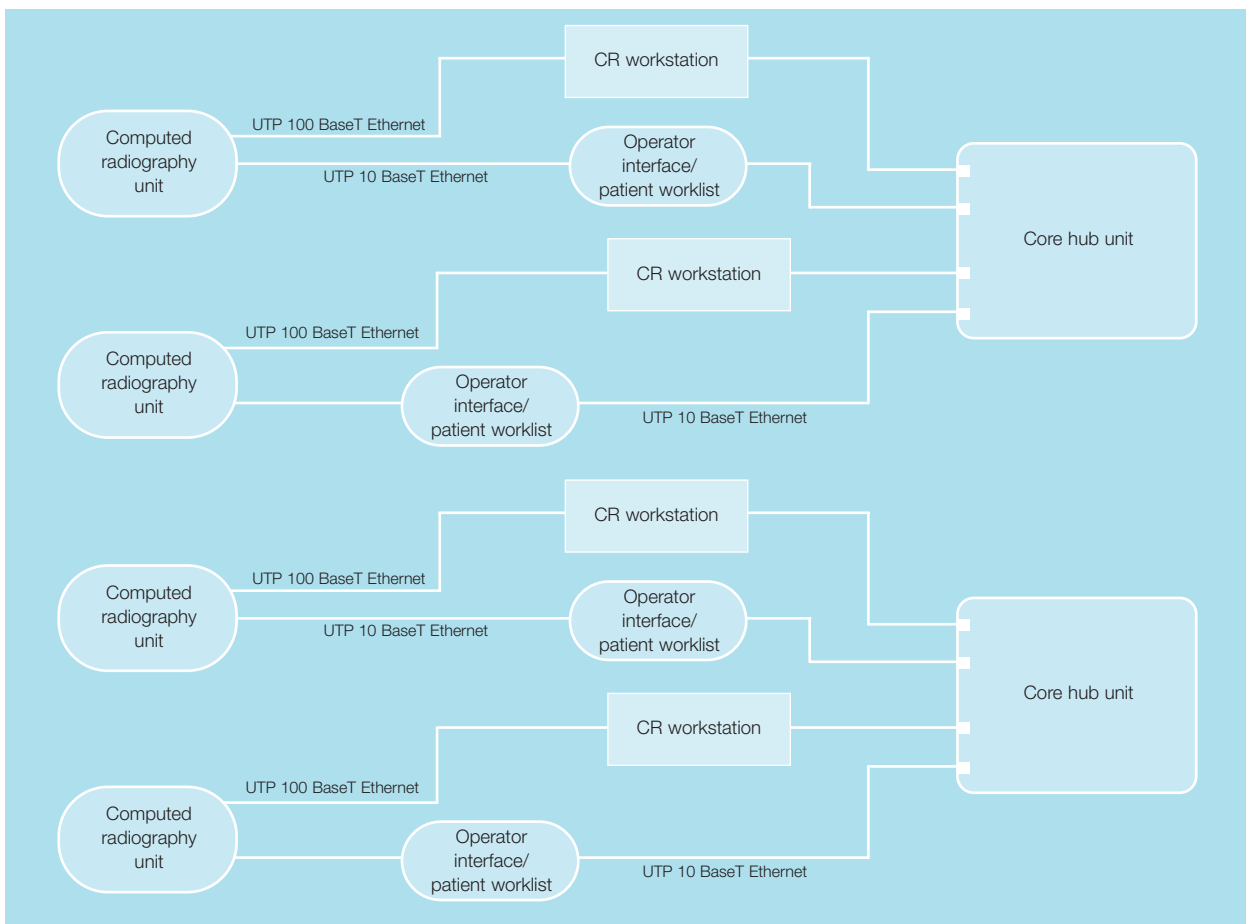

Figure 4.3 Example set-up for computed radiography systems, courtesy of Philips Medical Systems

- 10 BaseT allowing transmission at nominal rates up to 10 Mbits/second;
- 100 BaseT allowing transmission at nominal rates up to 100 Mbits/second.

These two standards can be supported by the use of UTP Cat 5 cabling, now commonly used in data/voice transmission systems. This can be used over a maximum distance of 90 m without requiring the use of signal amplification in the form of a repeater;

- Gigabit Ethernet, where the nominal transmission rates are up to 1000 Mbit/second.

4.149 It may be appropriate to support this mode of communication using fibre-optic physical connections as this will provide the fastest sustained transmission times for data communication and should allow greatest flexibility when upgrading the network. There are some limitations in the use of fibre-optic cables with respect to the radius of curvature for which cables can be laid. These limitations must be observed otherwise damage and/or breakage may occur.

4.150 One of the most important considerations in installing a high-speed network will be the physical layout of the cables within the structure of the radiology department. Before even contemplating the transition of PACS from a film/paper-based system, a structural survey should be undertaken within the department to ensure that the building is able to support the introduction of data cabling consisting of UTP and fibre-optic media. If the findings indicate that the department is not able to allow for the integration of the new network, the introduction of a PACS will need to be re-evaluated and alternative solutions proposed. However, mostly, conventional ceiling voids together with the use of suitable metal “cable trays” should permit the installation of appropriate cabling.

4.151 If UTP cables are installed in areas with high levels of radio-frequency interference or close to cable trays that contain mains, low- or high-voltage electrical supplies, this may cause interruptions in the data flows or errors to develop on these data communication lines. Therefore, a radio-frequency survey should be undertaken to identify those areas which may prove unsuitable for the installation of the UTP cables. It is also advised that the Cat 5 cables are not installed within the same cable trays as mains electrical distribution lines and are located at least 2 m apart.

Built environment and accommodation to support the design of suggested network solution

Core hub units

4.152 For the three primary core hub units of the PACS, shown in [Figure 4.2](#), space will need to be found within

the main department for their installation. As described previously, the hubs will form the backbone of the network and at least two will need to be functioning 24 hours a day, seven days a week, to maintain the operation of the system.

4.153 The hub units should not be installed within public or staff circulation areas as they may become accidentally damaged. They may also overheat due to poor environmental conditions or, in some cases, be at risk of being stolen from the department, or may present an unacceptable fire risk within an open area. They should therefore be installed in small, secure rooms within the diagnostic imaging department. Current installations for a single unit demonstrate that a room of approximately 5–10 m² will be appropriate to allow full access to the units for service and maintenance purposes. The actual space required will depend on the type of hub unit required and procured. It is advised that each room should only contain one hub unit as this provides for a distributed system and gives protection against possible major failures.

4.154 These hub unit rooms should be separate to the computer rooms to provide a distributed physical PACS infrastructure and some resilience against failure due to environmental conditions. Authorised radiology and IT staff may need to access the hub to undertake first-line maintenance on the unit, for example.

4.155 A number of data connections will need to be made from the core hub units to other areas as part of the network. The use of computer flooring in these rooms may be appropriate, together with surface-mounted conduits, or trunking, to allow the cabling to be installed between the hub units and the trays within the ceiling voids.

4.156 Space should be found for a minimum of three core hub units, but the system should be flexibly designed to allow the incorporation of additional units at a later stage in the development of the system, and to allow for expansion in the number of modalities or workstations. This will also increase the number of connections that need to be made between hub units and modalities to support the distribution of data at appropriate speeds. Spare space should therefore be made available within the cable trays and distribution terminals from hub rooms to allow the installation of additional fibre-optic and UTP cables in the future if required.

4.157 An example of a main hub unit used as one of the primary units in the construction of a PACS network is shown in [Figure 4.4](#).

4.158 The environment in the room should be controlled by air-conditioning units and consideration should be given to appropriate air extraction rates. These should be configured to maintain a constant temperature



Figure 4.4 Example of a hub unit that may be used as a core hub unit in a radiology network, courtesy of Cisco Medical Systems

within the room, as advised by the supplier or original equipment manufacturer for optimum operation of the equipment. The hub rooms should be sealed to prevent dirt and dust entering from adjacent areas, particularly where they are located near engineering or plant areas. Most hub units are able to continue operating at higher than optimum environmental operating temperatures, in some cases above 30°C. However, dirt and dust clogging the cooling fans, in addition to high operating temperatures, can significantly increase the risk of failure of the core hub unit.

4.159 Mains power connections to the hub units should be via an uninterruptible power supply (UPS), if one is not already fitted as standard within the unit. In addition, the units should also be connected to emergency supply generators. The UPS will ensure that the system does not fail in transient periods between the deterioration of the main supply and the emergency generators taking over. The units should not be earthed to the same circuits as those used for X-ray systems, as they are sensitive to any spurious signals, for reasons described in Volume 1 of this guidance. Some units may require dual power supplies to function appropriately. Consultation with potential suppliers should establish the need to provide this infrastructure.

Example ergonomic and environmental specifications for a single core hub unit

4.160 The hub unit will be supplied, or should be installed, in a metal cabinet with a standard racking and removable door. The enclosure should also be fitted with a rear panel door, and airflow to the rear of the unit should be considered for cooling purposes. The power supply to the hub unit will be connected to the rear of the cabinet. To prevent the device from overheating, no objects should be placed on the cabinet, as this will impede airflow to the back of the system. The unit

should be mounted on a plinth, and not on the floor of the hub room, to minimise the amount of dust that may collect either within the system or on any cooling fans that may be present.

4.161 There are a number of core hub systems, varying in size and specification, currently available from a large array of manufacturers and vendors. Designers are advised to check with potential suppliers as to the size, heat output etc of the core hub units supplied as part of the network and design the spaces accordingly.

4.162 To facilitate initial planning, example statistics for the units are listed below. They are provided in an outline guide only. Exact specifications should be checked with the manufacturer:

- approximate dimensions (H x W x D) for the unit would be 1000 x 500 x 500 mm. The shipping and delivery size of the unit may be larger and will depend on supplier. This should be checked before the unit is transported to the hospital. Additional space should be allowed for the unit to be installed in a suitable cabinet;
- approximate weight will be 70–110 kg. The shipping weight may be heavier than these specifications by about 25%;
- the operating temperature of the unit should be maintained at 10–40°C;
- the humidity should be non-condensing at 40°C with an overall permitted operating humidity of 5–85%;
- mostly, a standard single-phase 13 A power supply will be required, but with some systems multiple supplies may be required and with some larger systems a 30 A single-phase electrical supply is required. Most units can be supplied with a second redundant power supply connection if necessary;
- the heat output from the devices, such as the unit described above, will vary up to approximately 10 kW in the majority of cases, and will depend on the number of cooling fans fitted to the cabinet containing the hub unit;
- the acoustic noise output from the system will be approximately 60 dB. Acoustic shielding in some circumstances may be required;
- the airflow through the system should comply with manufacturers' requirements.

Built environment to support local hub units

4.163 Local hub units as part of the network should be installed within the department where appropriate space is available. It is recommended that they are not placed in either staff or public circulation areas as

they may represent a potential security risk or become accidentally damaged. In addition, it is recommended that the units are not installed in the ceiling voids as this will make maintenance and access to the units difficult, nor should they be installed in areas where there is a requirement to maintain a clean environment, such as catheterisation or interventional examination rooms.

4.164 The units should be installed within wall- or floor-mounted computer racking and located within a metal cabinet to prevent the accumulation of dust and other particles within the units themselves. The units are also susceptible to overheating and malfunction, as described previously.

4.165 An ideal location for the local hubs is within the machine rooms associated with discrete modalities, as it is probable that the environmental conditions will be controlled with air-conditioning and dehumidifying systems. These rooms should also be reasonably clean and relatively free of dust. The power supply and earthing arrangements for the local hubs will need to be carefully considered, particularly where they are installed with generator cabinets that may serve a discrete X-ray imaging system. It is recommended that they do not share the same earth with the X-ray imaging systems, for reasons described in the engineering section in Volume 1 of this guidance.

4.166 The number of local hub units requiring installation will depend on the design of the network and the size of the PACS but, in the majority of cases, a single local hub will be used to serve more than one modality or workstation.

4.167 To facilitate initial planning only, example statistics for the units are listed below. Exact specifications should be checked with the manufacturer:

- approximate dimensions (H x W x D) for the unit would be 100 x 500 x 400 mm. The shipping and delivery size of the unit may be larger and will depend on supplier. This should be checked before the unit is transported to the hospital. Additional space should be allowed for the unit to be installed in a suitable cabinet;
- approximate weight will be 8–12 kg. The shipping weight may be heavier than these specifications by about 25%;
- the operating temperature of the unit should be maintained at 10–40°C;
- the humidity should be non-condensing at 40°C with an overall permitted operating humidity of 10–80%;
- in the majority of cases, a standard single-phase 13 A power-supply will be needed but with some systems multiple supplies may be required. Most units can be supplied with a second redundant power supply connection;
- the heat output from the majority of devices, such as the unit described above, will vary up to approximately 2 kW, and will depend on the number of cooling fans fitted to the cabinet containing the hub unit.

RADIOLOGY INFORMATION SYSTEMS (RIS)

Introduction – what is a RIS?

4.168 An electronic RIS effectively replaces the use of a paper-based radiology master patient indexing system (MPIS). The RIS is used to store data on patients who



Figure 4.5 Example of a hub unit that may be used as part of the radiology network, courtesy of Cisco Medical Systems

have undergone, or who are about to undergo, a radiological procedure or examination.

4.169 The majority of RIS do not store radiological images but are mainly concerned with the efficient flow of text-based patient information within a diagnostic imaging department. The installation of an RIS is essential to the implementation of a full PACS. The RIS works in tandem with the IMS to allow authorised users access to a broad database of information related to the care of patients and maintain the efficient operation of a department. In full PACS, the RIS simply makes use of the high-speed network designed to carry information associated with the IMS.

4.170 The information overheads generated by a RIS are much smaller when compared with those commonly transmitted within an IMS. As such, RIS can be implemented as a stand-alone system (without an IMS) for the distribution of patient data utilising an existing hospital network infrastructure.

4.171 This is a valid approach and may be a first step to achieving full PACS, but the addition of the IMS will almost certainly require a dedicated high-speed network. The RIS should enable efficiencies in workflows and radiological interpretation over the use of paper-based operational procedures. This approach has been undertaken by a number of hospitals within the UK which have not yet implemented full PACS.

4.172 The functions performed by a RIS are described in the [Glossary](#).

4.173 For a RIS to work effectively, and generate a number of workflow efficiencies, it should be linked with the HIS. This will allow reports and other related radiological patient data to be transmitted to authorised clinicians working in other areas or hospital departments. Radiologists may also wish to have access to non-radiological data from pathology or other departments prior to making a diagnostic interpretation. For example, this may be the result of histological analysis following a biopsy procedure undertaken with radiological imaging guidance in the diagnostic facilities. The integration between the RIS, HIS and any separate pathology or other departmental information system should be flexible and effective.

Built environment to support the introduction of a RIS

4.174 The provision of RIS will increase the number of computer terminals or PCs that are located within the department. The PCs will all be networked to the main servers and used by the radiology team members to gain access to the patient data. The computer terminals and PCs should not be located in corridors or in other areas where patients may gain access to the data.

Security of computer workstations has been described previously in [paragraphs 4.123–4.125](#).

4.175 Where integration of multiple IT systems is developed and access to important RIS data (for example request forms and previous reports) is required at the imaging modality, there may be a need to provide a separate computing workstation. This will usually take the form of a high-powered PC connected to the RIS and, additionally, to the main imaging computer workstation console and in some cases the patient identification terminal. There should be sufficient space provided within the control areas and the modality processing areas for this additional RIS computer workstation. However, under future developments of IHE, this additional RIS workstation should not be necessary as the modality control consoles should allow access to all the information contained on the RIS archive and database.

4.176 The data volumes associated with RIS are much smaller (by a factor of 500–1000) when compared to those stored within the entire PACS system. As such, the RIS database and patient data can usually be stored on two main computer workstations (servers) or two computer workstations together with a small separate disk-based (RAID) archive. The use of two main servers or alternatively the two workstations and a RAID, is advised to ensure protection against a major failure, but also allows the system to be upgraded, expanded and developed. The majority of RIS systems are designed to allow an addition of further servers or archives as required, and space within a server room should be available to allow for this possibility.

4.177 The servers for the RIS would need to be installed in a dedicated computer room, as described in [paragraphs 4.211 ff](#). These systems could be placed in a separate room from those used to support the IMS and so provide protection against a major failure, for example a fire or computer failure.

4.178 Alternatively, the RIS and IMS may be fully integrated and may share servers, databases and archives. The level of technological integration will depend on the vendors selected for the IMS and RIS installations, the overall operational requirements, the risk analysis in terms of single points of failure, and the computing capacity of the IMS.

4.179 In either approach, the addition of a third, low-speed server should be integrated with the RIS in a separate area or building within the hospital or trust, to provide protection against fire, major failure or other problems that may develop with the main servers or workstations. This third server would be connected to the RIS via a simple network connection. The third server could also be used to provide a service when the two main units are being upgraded or undergoing routine maintenance.

4.180 The third unit could take the form of a high-powered PC, having a large hard disk capacity or separate small RAID. The third server would contain a complete copy of the entire database and patient archive, data and other text-based information. This system should be installed in a computer room such as those described in paragraphs 4.192–4.236. In some circumstances the space may be shared with systems provided for use with the HIS or other PAS. In some instances the third party supplier may be able to provide this backup facility and this should be investigated by the trust.

4.181 Considering the low price of providing such a back-up facility, the potential benefit should be carefully considered against the overall risk of losing patient data. The back-up would maintain continuity of patient care and retain a copy of the radiological reports under virtually all circumstances. As described in Volume 1 of this guidance, the radiological report is considered to be the primary legal document, and appropriate means of risk control should be applied to maintain this data over a period that meets the requirements of the regulations.

Potential impact on patient flow and reception/ appointments areas from the introduction of a RIS

Electronic scheduling of patients

4.182 The RIS will contain and incorporate scheduling functions so that patients can be booked in advance for their examination(s). In some cases, this function may work with other PAS, for example by co-ordinating the out-patient appointments with those in radiology, and thereby improving patient care and continuity and potentially reducing the number of multiple patient attendances over separate days.

4.183 The impact on the built environment afforded by PACS and by electronically booking patient appointments, combined with easier access to radiological information outside the department, will ensure that workflow efficiencies in throughput are achieved – and, potentially, a reduction in the space requirements for patients waiting for their examination. This will only apply to those waiting areas that support diagnostic imaging rooms in which the numbers of patients can easily be predicted.

4.184 Theoretically, the number of changing cubicles may remain the same or increase as the throughput of patients changing for an examination may also increase. Sometimes this will depend on how the changing cubicles are integrated within the radiology imaging room as described in Volume 1 of this guidance.

Patient booking and appointments office

4.185 An appointments office should be created in the department as it is unlikely that this function can be

supported at the main reception desk. This should cover all the modalities across the whole of the trust or hospital, ensuring that all available resources are used appropriately and effectively.

4.186 To minimise potential conflicts, the computerised scheduling software can be programmed by users to ensure that non-urgent cases do not conflict with patients attending the hospital in an emergency.

4.187 The appointments area should be of sufficient size to accommodate two persons equipped with computer workstations and where possible it should have an outside window.

4.188 Adequate and suitable storage space for records should be provided.

4.189 It is likely that the staff will work in these areas for long periods of time; therefore, the overall design and environment of the office should be sympathetic. High-speed data points should also be provided to allow for communication of information with the RIS and IMS.

4.190 In order to comply with the government's booked admissions strategy many more staff and workstations may be required to support this process. A telephone appointments system is much more people- and time-intensive than a postal system. In the future appointments will be centralised for all aspects of patient care, that is, outpatient appointments, radiological investigations and elective surgery etc. This needs to be considered when designing new facilities that support electronically booked admissions.

System manager's office

4.191 If the RIS is installed, either with or without an IMS, a system manager should be appointed to manage the system and provide first-line maintenance as agreed with the supplying company. The requirements are described in [paragraphs 4.221–4.222](#).

IMAGE MANAGEMENT SYSTEMS (IMS)

Introduction

4.192 This section covers the built-environment requirements for the installation of an IMS and associated digital archives. A small amount of background information is provided on the functions performed by an IMS, together with a suggested technical solution to the archiving challenges. The built environment required to install the equipment into a new or existing department is then described in detail.

4.193 An IMS will manage, store and communicate the images acquired at each of the diagnostic modalities to other parts of the department or hospital. The functions of the IMS are undertaken, automatically, semi-automatically or with manual intervention. The primary

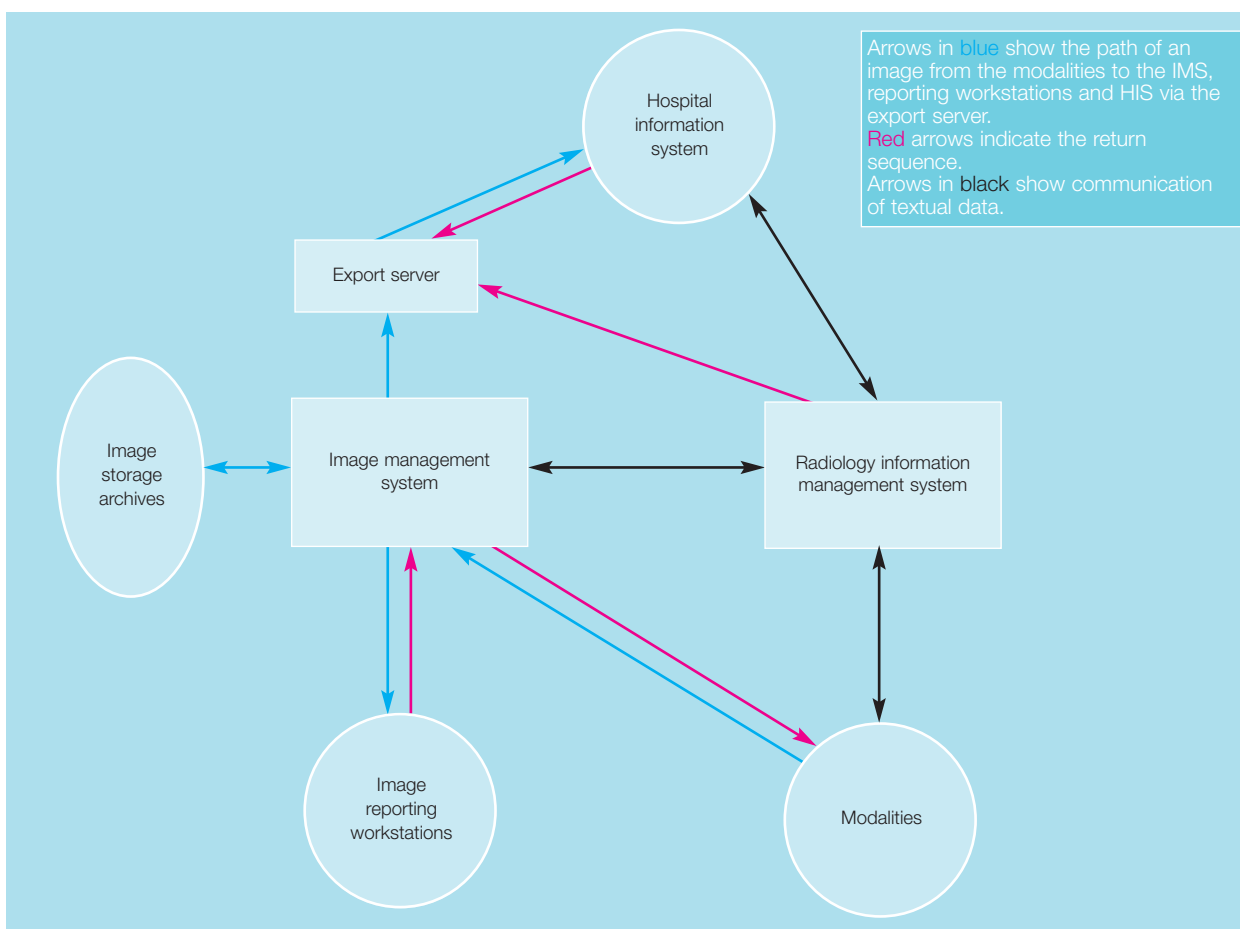

Figure 4.6 Schematic diagram showing the routes of communication between image management systems

functions of the IMS are briefly described in Figure 4.6, which shows the route of communication between the IMS and other systems, modalities and workstations.

Image storage and access

Introduction

4.194 The archiving solution to store all the images acquired in a diagnostic imaging department will be relatively unique in terms of hospital information storage requirements. A highly developed hierarchical solution is therefore required.

4.195 The volume of digital data associated with radiological images is much larger when compared with other hospital requirements. The amount of information that needs to be stored is considerable, particularly if, for example, a relatively large DGH generates approximately 100,000 examinations per annum with each examination requiring, on average, approximately 25 Mb of storage space. The provision of an appropriate archiving strategy is a major challenge in implementing PACS, and the eventual solution of the archive will have an impact on the design of the built environment.

Overview

4.196 The size of the hospital and the number of modalities installed and examinations undertaken per

annum will determine the amount of data storage required. This should be established at an early stage of project planning as it will have a direct impact on the facilities required. The digital archive should allow for an increase in data volumes of 5–10% compounded per annum, depending on the expected growth of the department (Hospital Activity Data on Imaging and Radiodiagnostics, 1999).

4.197 Data archive storage requirements should have a large redundancy, as image resolution is likely to increase greatly in the future, with the knock-on effect of much greater storage capacity requirements. This will have an impact on the size of facilities that need to be provided for digital archiving.

4.198 The images may not be contained within a single digital archive but within multiple systems to meet the requirements for speed of image access and value for money. The approach used for archiving the images, together with the length of time they are kept by the hospital, will have an effect on the design of the built environment.

Storage time requirements

4.199 Relevant guidance notes, together with established custom and practice in each trust, will require that images on a PACS system are stored for

the same amount of time as those acquired using hard-copy film. The data size of the archive should reflect the existing operational practices of the hospital in the storage and retention of radiological images. Any changes to these operational requirements should be considered in the early stages of project planning, as this will have an indirect effect upon the installation environment and space required.

4.200 In some cases, particularly in research institutions, films may have to be stored for much longer periods, possibly up to 50 years.

Access requirements to images

4.201 The image access requirements of clinicians and radiologists generally decrease over time. Images that are only a few weeks old are accessed most frequently and these should therefore be the most accessible within a PACS network and deliverable at high speeds to both radiologists' and clinicians' workstations. Once a radiological study becomes more than two to three months old, the frequency with which it is reviewed dwindles dramatically and then falls slowly over a period of approximately two to three years. Some older images may be reviewed more frequently if marked as being suitable for teaching and research purposes or where considered useful in the care of the patient.

4.202 The number of times an image may be accessed by clinicians should be reflected in the design of the archive in order to achieve value for money. This will have a direct effect on the design of the built environment and the overall space required.

Data compression

4.203 To reduce the overall data volumes, it is possible to digitally compress the data size of the images and therefore the overall space required for the digital archives. Current technology supports digital diagnostic image compression using low compression ratios – up to a maximum of 2.2 for all types of images. Compression algorithms (lossy) that work at ratios higher than 2.2 lose some of the original data in the process and may make the image unsuitable for primary reporting by radiologists.

4.204 A more detailed description of data compression can be found in the [Glossary](#).

Suggested technical solution

4.205 To meet the data storage requirements described above, it is customary to provide a hierarchical approach to the storage of radiological images which is both economical and operationally effective. A solution to the challenge of storing images on a PACS system, which meets all the requirements and recognises the working practices of clinicians and radiologists, is shown in [Figure 4.7](#).

4.206 The RAID and medium-term archives will be housed in the main computer room described in [paragraph 4.211](#). The disks removed from the medium-term archive will be stored in a separate, but adjacent, room within fire-resistant cabinets.

4.207 A potential solution for the storage of images is shown in [Figure 4.7](#). This is also briefly described below:

- radiologists' image reporting workstations, located in offices and reporting areas, would be used to temporarily store images whilst they are being reviewed during reporting sessions;
- a central fast-access storage, such as a RAID, would store images that have been recently acquired. The RAID will supply sufficient storage capacity to allow for between two and eight weeks' storage of images, depending on operational practices.

4.208 If the PACS is implemented across a number of sites that are undertaking radiological examinations, there may be a need to install multiple RAID systems at each of these sites, together with an appropriate server. Data from the RAID units could then be automatically transmitted to the main medium-term archive using the hospital network at times of low activity or workload. Each of the multiple RAID systems and associated servers will need to be installed in separate computer rooms with appropriately controlled environmental conditions:

- an automated medium-term archive such as a CD-ROM or high-capacity tape jukebox should be installed. In either case, the CD-ROM or tape archive may be made up of multiple cabinets and drive units. There may be advantages in providing two small digital archives rather than a single large unit, as this means achieving redundancy in the system. The medium-term archive will have a storage capacity of 5–10 Tb and be able to store images acquired for approximately two or possibly three years;
- so-called "long-term shelf storage", fire-resistant cabinets will be used to store CDs or tapes older than two to three years. These will be read by manually inserting the appropriate volume into a drive unit provided for the purpose. The database contained within the IMS will continue to track images when the archive volumes are stored "offline" in this way. Long-term shelf storage may not be required if the hospital decides not to keep images greater than three to four years old.

IMS servers

4.209 The image archives will be connected to one or more large computer workstations that will hold all the patient databases for the RIS and IMS. These will be used to access the data held on the separate archives

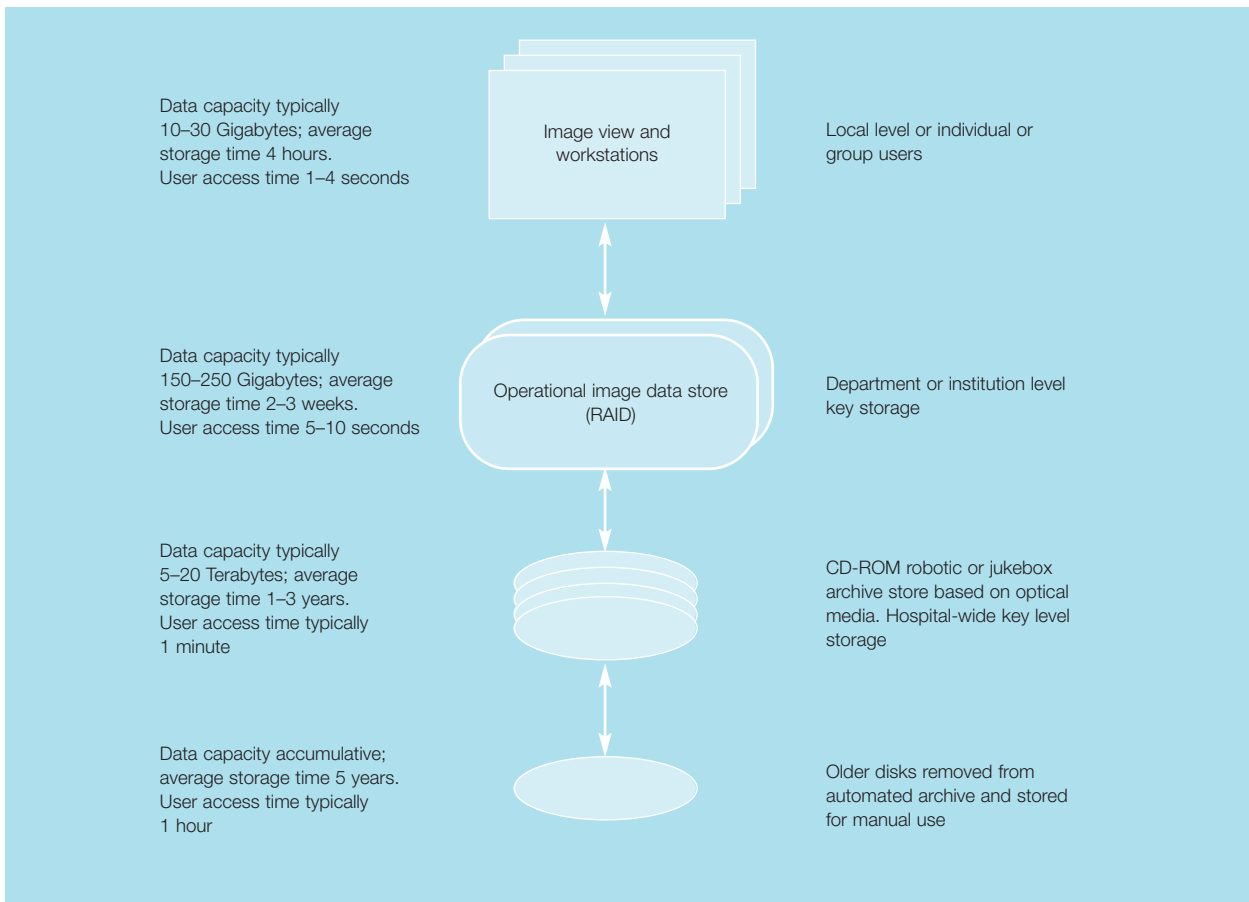

Figure 4.7 Suggested solution for storage hierarchy of radiological images

and also hold details of where it is spatially located within the storage media.

4.210 Instead of procuring a single large server unit, which may make the system vulnerable, the department may procure two smaller servers to hold patient databases and undertake functions associated with the RIS and IMS. It is likely that each server will be able to meet the operational requirements of the system if the other unit fails or develops a fault. This will also allow for some spare capacity for future development and expansion if required. Space should therefore be allocated to install these units.

Accommodation requirements – servers and short- or medium-term archives

4.211 It is advised that the RAID, medium-term archive and two servers are installed in a single computer room and connected using high-speed data links. The location of the room should ideally be on the periphery of the main diagnostic imaging department so that radiographers working outside core hours can access it.

4.212 However, depending on hospital layout and available space, this accommodation may alternatively be located away from the department, with appropriate high-speed data links of around 1 Gb or greater in place.

4.213 An office will need to be located adjacent to the computer room as a base for system maintenance engineers and managers.

4.214 A number of high-speed connections between the servers and archives will be needed to allow the transfer and routing of data. The use of computer access flooring will allow easy installation of cables and other conduits and replacement when these come to the end of their useful life. However, the computer flooring should be able to support the weight of the archives and the servers within the room. In some cases this can be considerable (up to 35 kg per archive “drive” cabinet), and there could be up to eight or possibly more of these cabinets within single-width computer racking. A number of companies now provide storage solutions which can be upgraded or increased over a period of time to meet operational requirements. Therefore, space should be allocated within the archive and server room for further development and additional disk drive cabinets.

4.215 The V-LAN network controller should be installed in this room, together with the servers and archives. Space should be left around this unit for maintenance and cooling requirements, and it should be mounted on a plinth.

4.216 The archives and computer cabinets should be mounted on suitable plinths, rather than at floor level, to minimise the amount of dust and dirt that is collected by the internal electronics of the system. Dust contamination may reduce the period between maintenance inspections and increase time between failures. Additional space should also be allocated for expansion of the systems at a later date. Space to the front, rear and sides of the archives will also be required for maintenance purposes. If this is not provided, it may increase the contract price for the maintenance of the systems. The actual amount of space required for maintenance purposes would depend on type and manufacturer/supplier but in most cases this will be approximately 500–1000 mm.

4.217 The room should be designed to accommodate air-conditioning units to keep the servers and archives operating within optimum temperature ranges, as the heat output from these devices can be considerable.

4.218 Security for these rooms will be important and should be designed to prevent unauthorised entry. The provision of security door locks and CCTV may be an effective solution.

4.219 The archives and servers will hold data essential to the function of the hospital, and therefore the incorporation of an automatic fire detection and extinguishing system must be considered. A fire extinguisher should be supplied as part of the standard fire-fighting equipment available within the room.

4.220 It may also be advisable to ensure that the equipment is installed in a one-hour fire compartment, as a means of protecting the data.

System manager's office

4.221 An office will be required for the person managing the PACS. The system manager's office should be located in the diagnostic imaging department and adjacent to the archiving and server room described above. The system manager will need to change over the power supplies of the system or conduct some basic first-line maintenance and recovery procedures.

4.222 This should be a two-person office, as described in HBN 18, 'Office accommodation in health buildings', with the following additional measures:

- the system manager will have full access to the data stored on the archives and servers. Access to the office will therefore need to be carefully controlled with security locks and alarm systems if appropriate;
- the room should be fitted with two high-speed fibre-optic data connections for redundancy purposes, operating at 1 Gb/second, one connected directly to the main servers and the other through the switched hub network. These will be required because the

system manager will need to undertake routine maintenance of the information held within the IT system databases and archives;

- appropriate workspace will need to be provided to accommodate at least two 21-inch-monitor computer workstations;
- the provision of computer flooring may be appropriate in this area;
- it is likely that the person concerned may spend long periods in the room working at a computer and therefore the room should be fitted with a window blackout blind as required, user-controlled air-conditioning and suitable lighting.

Long-term archiving accommodation

4.223 If the hospital stores radiological images older than three to four years, CDs or tapes will need to be stored off-line in fireproof boxes within a large room adjacent to the main archive and the system manager's office. The fireproof boxes should be mounted on shelves within the space, each 1000 mm deep and extending from the floor to the ceiling. The room should be sized to accommodate a minimum of seven years' data or radiological information, as this will allow for departmental expansion.

4.224 The room should be designed to allow for access by one or more persons, and the fireproof boxes should be mounted on shelves fixed to the walls of the enclosing space. The walls must be designed to withstand the weight of the media stored.

4.225 The number of shelves needed will depend on the amount of data that is generated by a department annually. The calculation should also be based on the type of storage media used – for example CD-ROM, tape cartridge, magneto-optical disk (MOD) or digital versatile disk (DVD).

4.226 The disks stored in the long-term archive will need to be catalogued and monitored to ensure that they match with the locations listed in the main database within the IMS database. Access to the long-term archive should be controlled to allow only authorised users, as described previously. Each of the fireproof containers should be fitted with key locks as a further measure of protecting access to the information. A 30-minute fire compartment should suffice.

4.227 An indicative size of the room to store the long-term archive will be 30 m². This space can be taken from a previous film storage area and the space size is based on a department generating approximately 5 Tb (5000 Gb) of uncompressed data per annum of information per year. This would be typical of a large DGH.

Engineering requirements for server, medium- and short-term machine rooms

4.228 Example engineering statistics are not provided as there are multiple set-up permutations as well as a wide range of products available from a number of manufacturers. To provide specific examples would be misleading to designers and planners. However, some general information and warnings are described below.

4.229 Some archive systems may require a chiller unit for cooling purposes and a separate chiller unit may have to be procured or capacity identified within an existing hospital system.

4.230 Some electronic archiving systems will incorporate a separate power cooling system and in these instances, additional single-phase power supplies over and above those for the main unit will have to be installed.

4.231 Power supply to the archive should be from the essential maintained circuits. This will ensure the archive will maintain its function in the event of a mains power failure. It may be appropriate to connect the archive to a UPS as a means of managing the transient period between the failure of the main supply and start-up of the emergency power. Some systems may also require dual power supplies and these should be accommodated in the design of the archive/server room.

4.232 The provision of UPS devices and emergency back-up services should be part of the estates risk management strategy for the whole organisation in ensuring that the PACS system remains operational almost 24 hours a day, seven days a week. In devising this strategy, consideration should be given to redundancy, upgradability and single points of failure within the UPS system provided.

4.233 The heat output from the servers and archive systems will be considerable, and devices can become overheated due to environmental conditions, creating a high risk of system failure. Centralised or local air-conditioning should be provided within the room to maintain the units at an optimum operating temperature and relative humidity. The air-conditioning unit should also be fitted with alarms to indicate failures.

Back-up solution

4.234 As part of the trust's contingency plans in the event of a major system failure or fire, a back-up storage solution should be procured as part of the IMS. This should be in a separate location to the main archive and server. This will ensure that the hospital can continue with normal clinical operation and access the images previously acquired. A separate fibre-optic fast-connection network should be made to the back-up

archive. Alternative solutions based on risk and cost benefit should be assessed and implemented.

4.235 The following components could be installed on a remote site:

- an operational RAID-based unit for fast access to images that have been recently acquired;
- a low-speed, high-access time Terabyte capacity disk or tape archive. This archive will provide image storage, possibly for up to five years depending on workload etc.

4.236 The back-up server and archives will need to be installed in a computer room as described previously.

OVERVIEW OF PACS IMPLEMENTATION OUTSIDE RADIOLOGY FACILITIES

Introduction

4.237 PACS should be implemented across the whole of the hospital and/or trust environment. The PACS system should encompass such areas as out-patients, wards, pathology and histology departments, plus other relevant clinical and diagnostic domains. PACS should afford full integration and flexibility of the system between the various clinical areas, ensuring patient care is optimised.

4.238 Measures must be in place for ensuring the smooth management of the operation. Similar procedures have been discussed previously. There follows a description of the essential technical and administrative route(s) that need to be pursued.

Allocation of operating and administration space

4.239 A dedicated or multimedia computer terminal or PC will need to be networked into the hospital's RIS and IMS. Sufficient space must be allocated to the computer operator, such that they can work effectively in an uncluttered environment. The size of space required should be a desk of no less than 1.5 m long and 1 m deep. This size of space should permit the placement of a further networked modality/hospital terminal, that is, HIS.

4.240 In a general ward environment the workstation could be located at the nurses' station, provided there is suitable space available. It is likely that the workstation will be the same unit used to gain access to information held on the HIS. Images from the radiology system will be received via the PACS export server, as described above, and the users will have the opportunity to query the main PACS database from this terminal.

4.241 Where the computer workstation is directly connected to the PACS network, a dedicated system will be provided. This may be in orthopaedic clinics,

CCU, operating theatres etc, where a high traffic of radiological data is expected or there is a requirement to view full-quality images. As such, single- or even multiple-dedicated terminals may have to be located in these environments or within consultation rooms. In CCU areas these terminals could be located in small bays or at the central nurses' base station. The use of radio-LAN systems may be appropriate in this environment as a means of providing information directly at the patient's bedside. These should only be installed following an appropriate risk assessment and an evaluation of their potential effects on other equipment.

4.242 Further dedicated space, in the form of shelves or filing cabinets, should be allocated for the local storage of patient information in paper form. The number of shelves or filing cabinets required will depend on the amount of information and data that is generated annually.

4.243 Depending on the size and layout of available space, air-conditioning units may not be required. Suitable lighting must be installed to ensure that there is no glare either from or on the screens and that radiological images can be viewed in low lighting conditions as required. The provision of such lighting should ensure that this does not impede other forms of work in the department, and task-focused lights may have to be provided. It is recognised that in some environments it may not be possible to provide dim lighting conditions for the viewing of images.

4.244 The position of the terminals with respect to patient areas should take into account those considerations detailed previously.

Appendix 1 – Ergonomic drawings

BONE MINERAL DENSITOMETRY

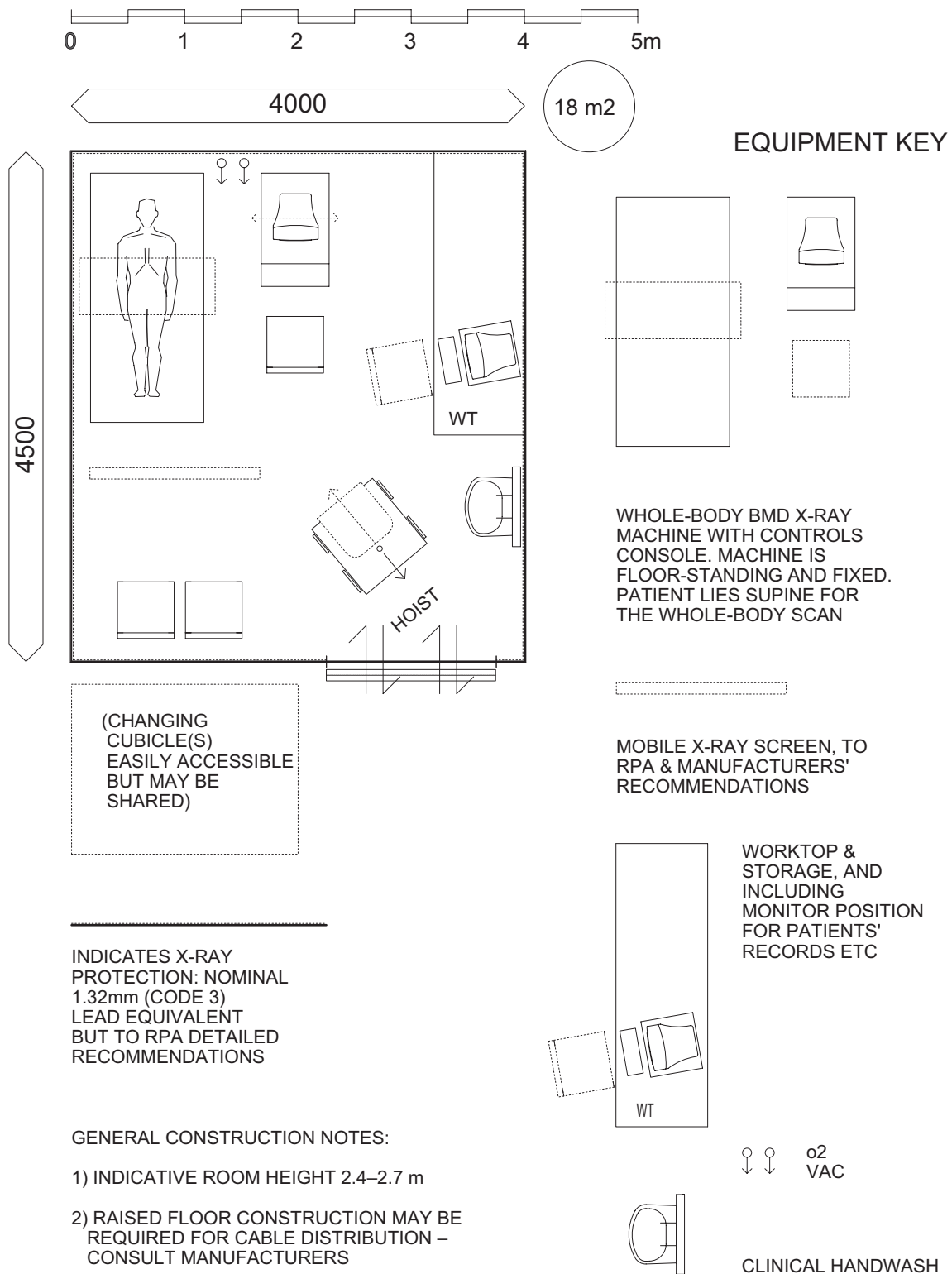

NEURO ANGIOGRAPHY SUITE: INDICATIVE ROOM RELATIONSHIPS

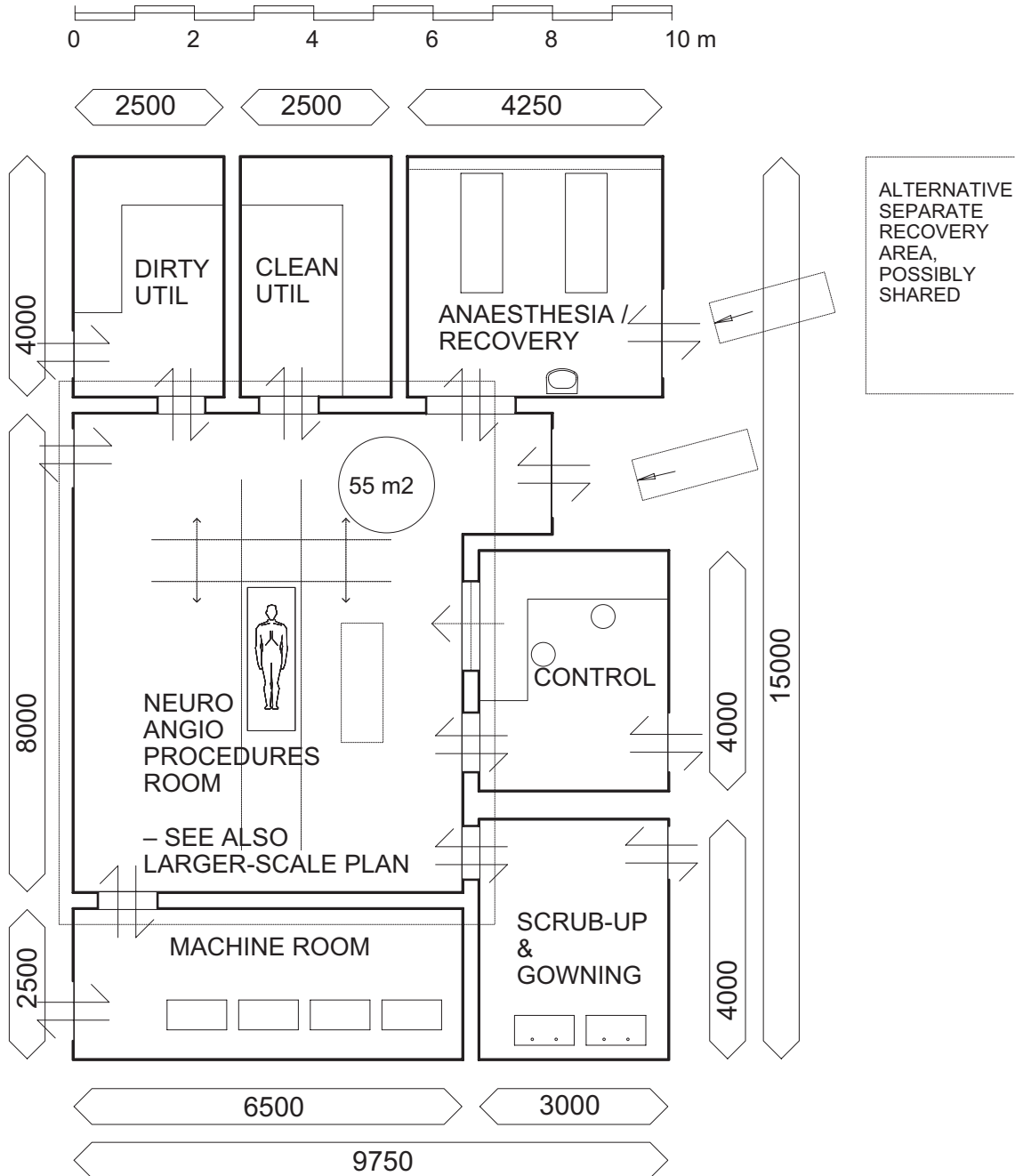

Note: this generic plan emphasises room layouts and adjacencies. It does **not** allow for other specific design requirements such as fire safety planning. Project and design teams must additionally consider such design factors, and adapt the generic plan accordingly.

NEURO ANGIO PROCEDURES: EXAM/INTERVENTION ROOM

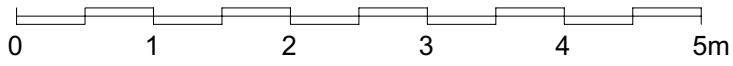

SEE ALSO
SEPARATE KEY
TO CLINICAL
EQUIPMENT

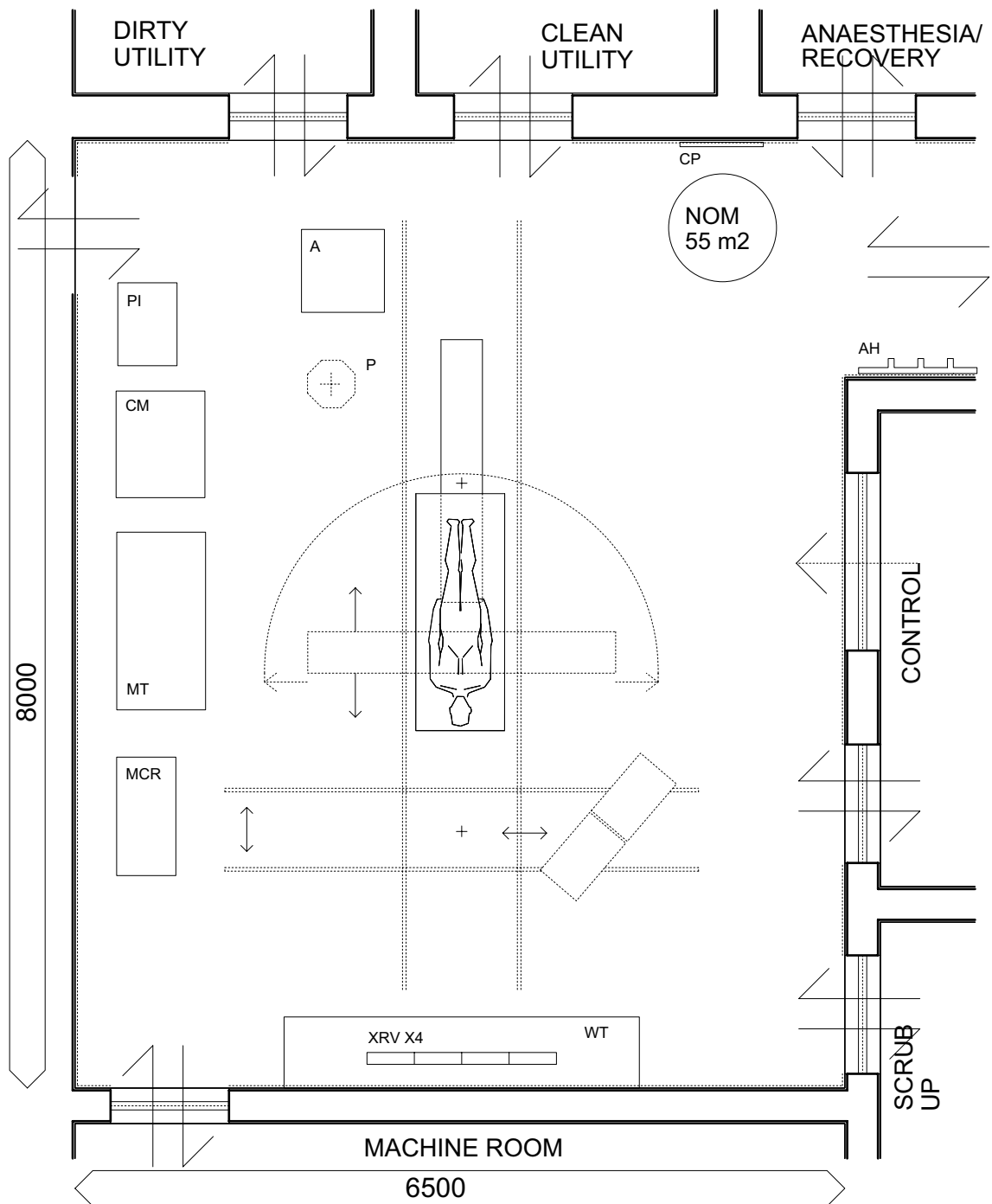

NEURO ANGIO PROCEDURES ROOM KEY TO CLINICAL EQUIPMENT/FITTINGS

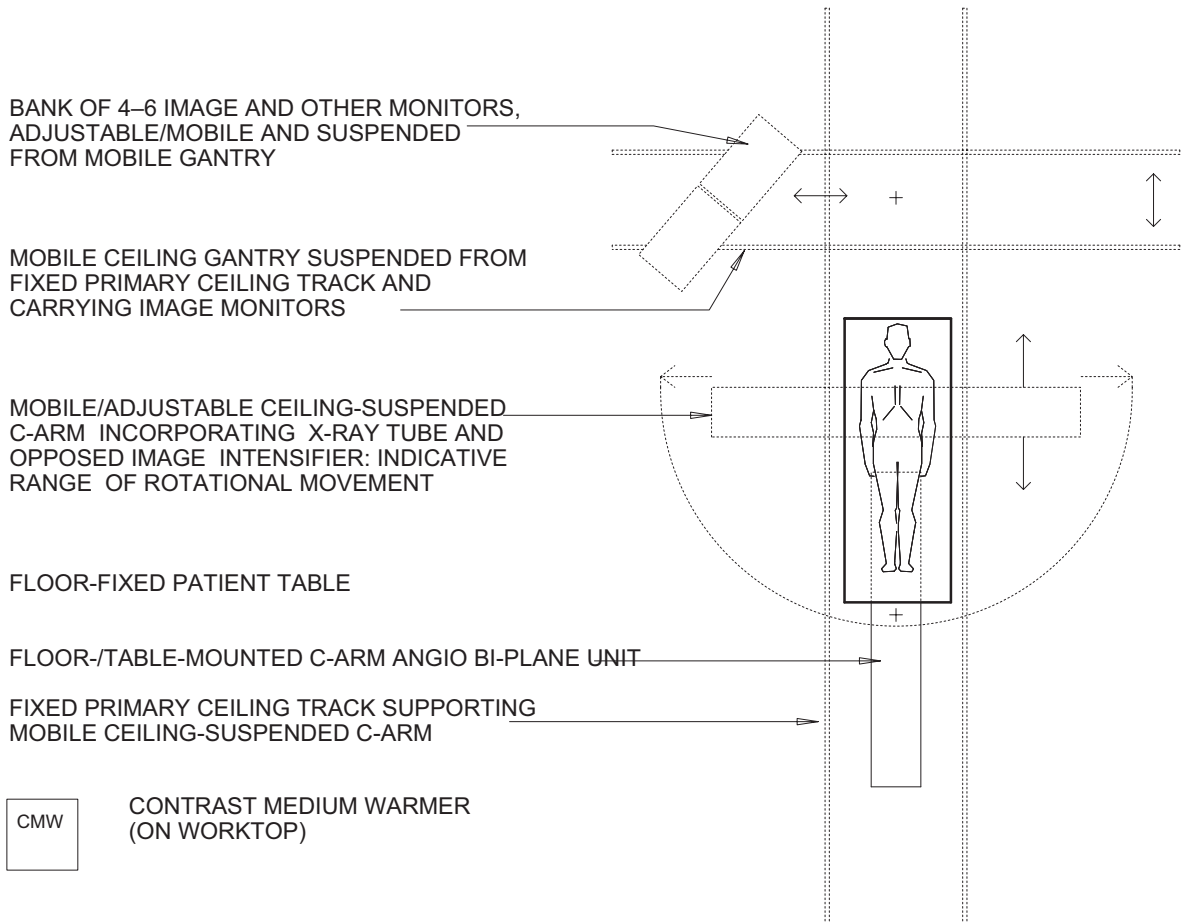
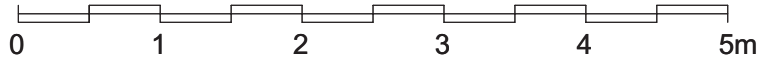

BANK OF 4-6 IMAGE AND OTHER MONITORS, ADJUSTABLE/MOBILE AND SUSPENDED FROM MOBILE GANTRY

MOBILE CEILING GANTRY SUSPENDED FROM FIXED PRIMARY CEILING TRACK AND CARRYING IMAGE MONITORS

MOBILE/ADJUSTABLE CEILING-SUSPENDED C-ARM INCORPORATING X-RAY TUBE AND OPPOSED IMAGE INTENSIFIER: INDICATIVE RANGE OF ROTATIONAL MOVEMENT

FLOOR-FIXED PATIENT TABLE

FLOOR-/TABLE-MOUNTED C-ARM ANGIO BI-PLANE UNIT

FIXED PRIMARY CEILING TRACK SUPPORTING MOBILE CEILING-SUSPENDED C-ARM

CMW CONTRAST MEDIUM WARMER (ON WORKTOP)

PI CONTRAST MEDIUM POWER INJECTOR (MOBILE & REMOTE CONTROL)

CM PATIENT LIFESIGNS MONITOR (MOBILE)

MT IMAGE MONITOR /COMPUTER (ON MOBILE DESKING)

MCR MOBILE RACKING FOR CATHETERS ETC

A ANAESTHETIC MACHINE

P FIXED CEILING PENDANT FOR MED. GAS /POWER

CP ROOM VENT CONTROL PANEL

AH LEAD APRON ETC HOOKS

XRV WALL-MOUNTED X-RAY VIEWERS

PACS CLINICAL CONFERENCE ROOM

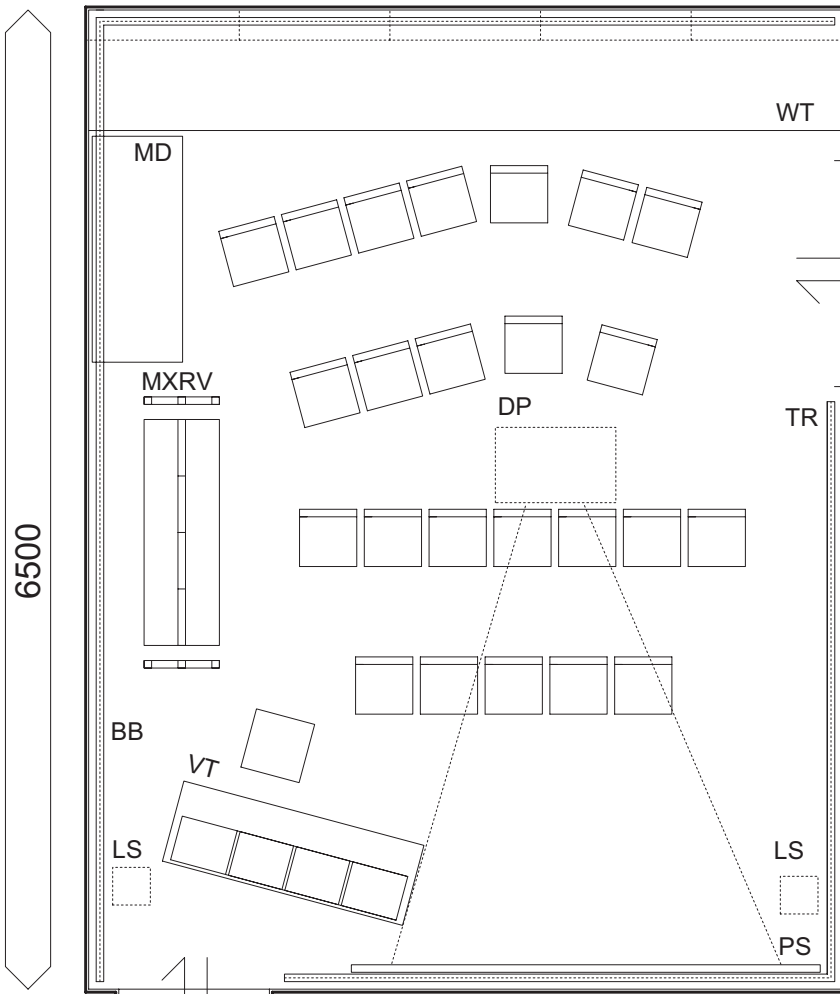
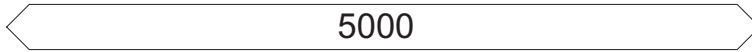
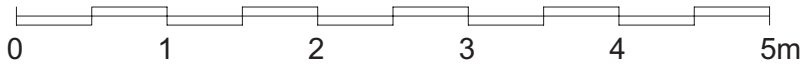

EQUIPMENT KEY:

- WT WORKTOP & CUPBOARD STORAGE UNDER, SHELVES OVER
- MD MOBILE DESK
- DP CEILING-HUNG DIGITAL PROJECTOR
- TR POWER/DATA TRUNKING
- MXRV MOBILE X-RAY VIEWING SCREEN, ILLUMINATED, NOM 8-SCREEN
- BB BLACK-OUT BLINDS (IF REQUIRED)
- VT MOBILE IMAGE MONITOR TROLLEY
- PS WALL-FIXED PROJECTION SCREEN

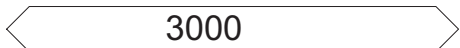
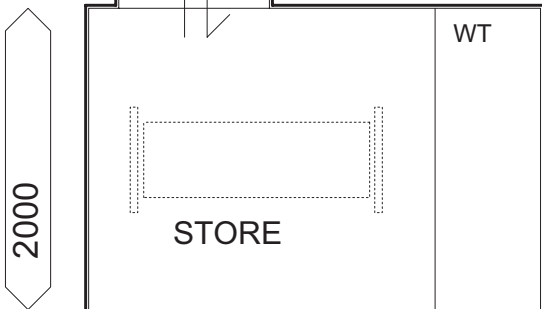

ROOM ENVIRONMENT:

- 1) LOW-GLARE LIGHTING FOR VIEWING IMAGE MONITORS
- 2) BLACK-OUT BLINDS IF REQUIRED
- 3) MECHANICAL VENTILATION
- 4) LOCKING/SECURE STORE

REPORTING ROOMS FOR DIGITAL DIAGNOSTIC IMAGES

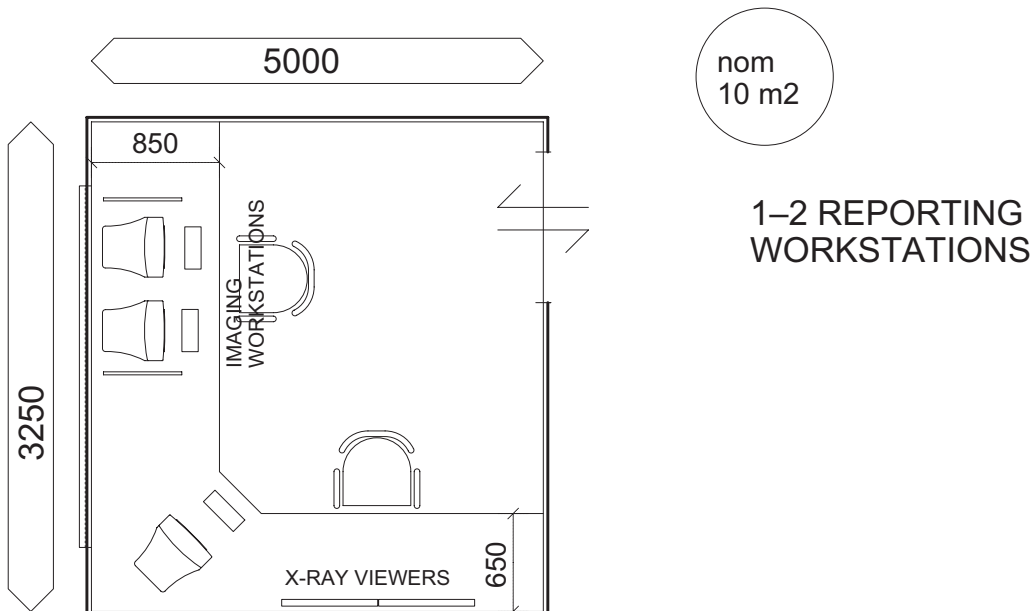
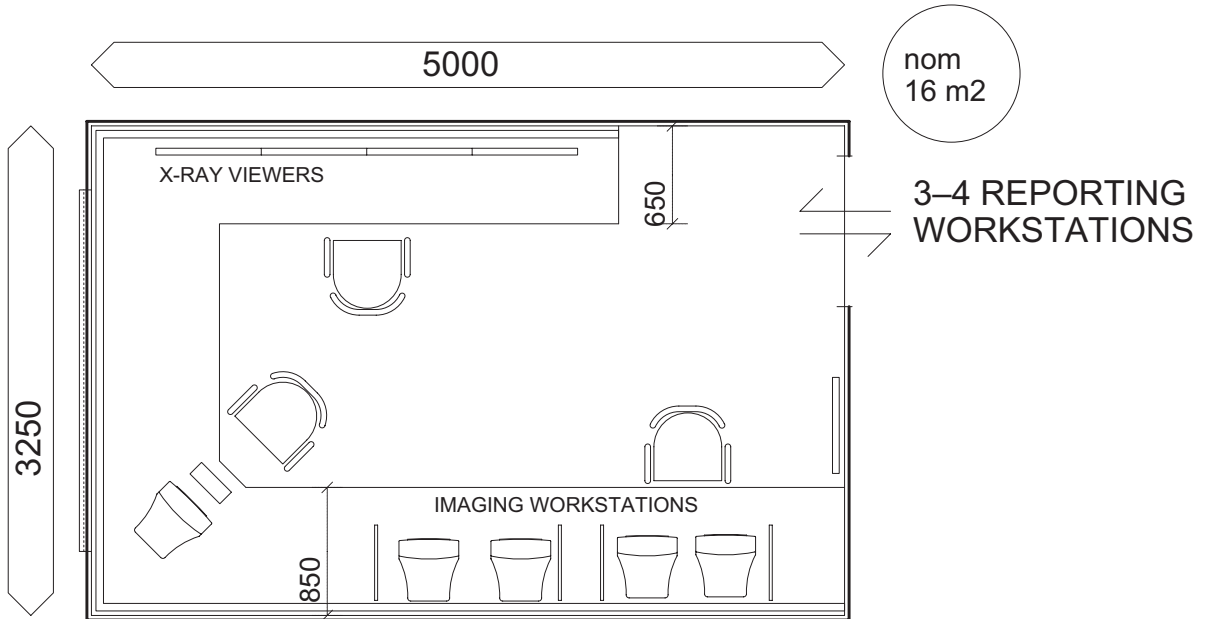
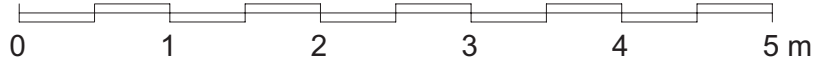

PACS SERVER/ARCHIVE ROOM AND CORE HUB SPACES

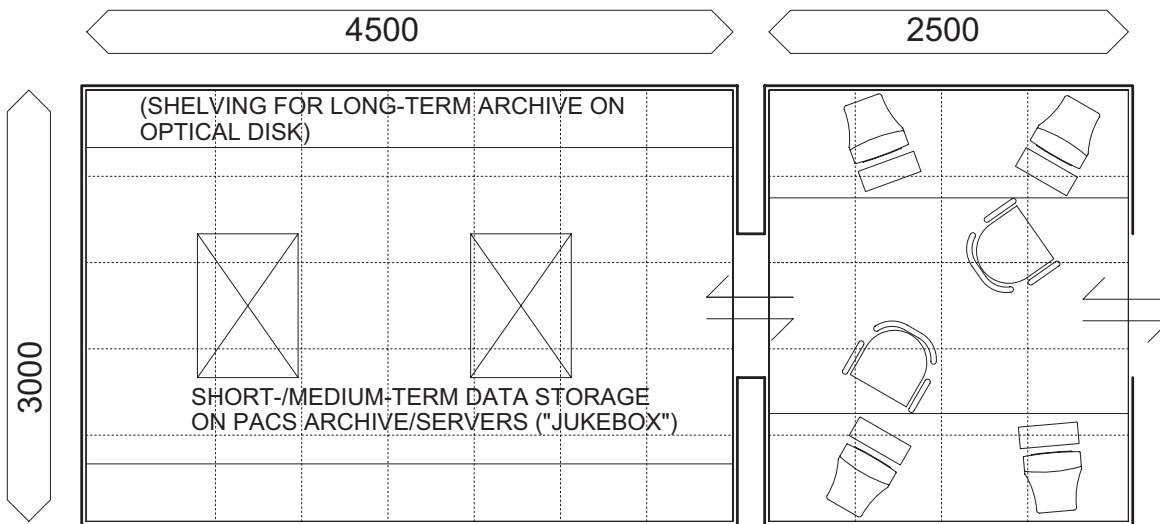
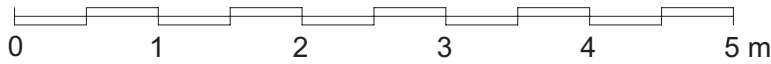

PACS SERVER/ARCHIVE

SUPPORT OFFICE

21 m²

SERVER/ARCHIVE SPACE & SUPPORT OFFICE TO HAVE:

- 1) RAISED ACCESS FLOORING
- 2) AIR-CONDITIONING
- 3) INERT GAS FIRE DETECTION & EXTINGUISHING SYSTEM
- 4) SECURITY/LOCKING

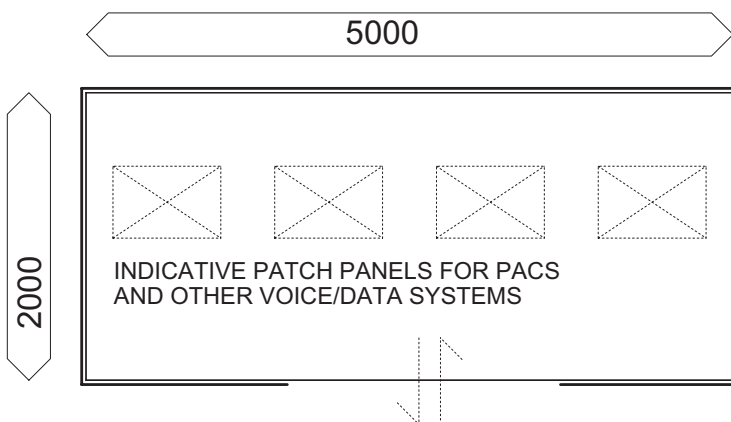

CORE HUB SPACE: INDICATIVE – SHOWS HUB SPACE SUITABLE FOR VOICE/DATA DISTRIBUTION AS WELL AS PACS

10 m²

PACS CABLING WILL TYPICALLY COMPRISE PRIMARY RING FROM ARCHIVE TO CORE HUBS, IN FIBRE-OPTIC CABLE; WITH RUN-OUTS IN CAT 5 CABLE FROM CORE HUBS TO INDIVIDUAL WORKSTATIONS ETC

DENTAL DIAGNOSTIC IMAGING SUITE: INDICATIVE ROOM RELATIONSHIPS

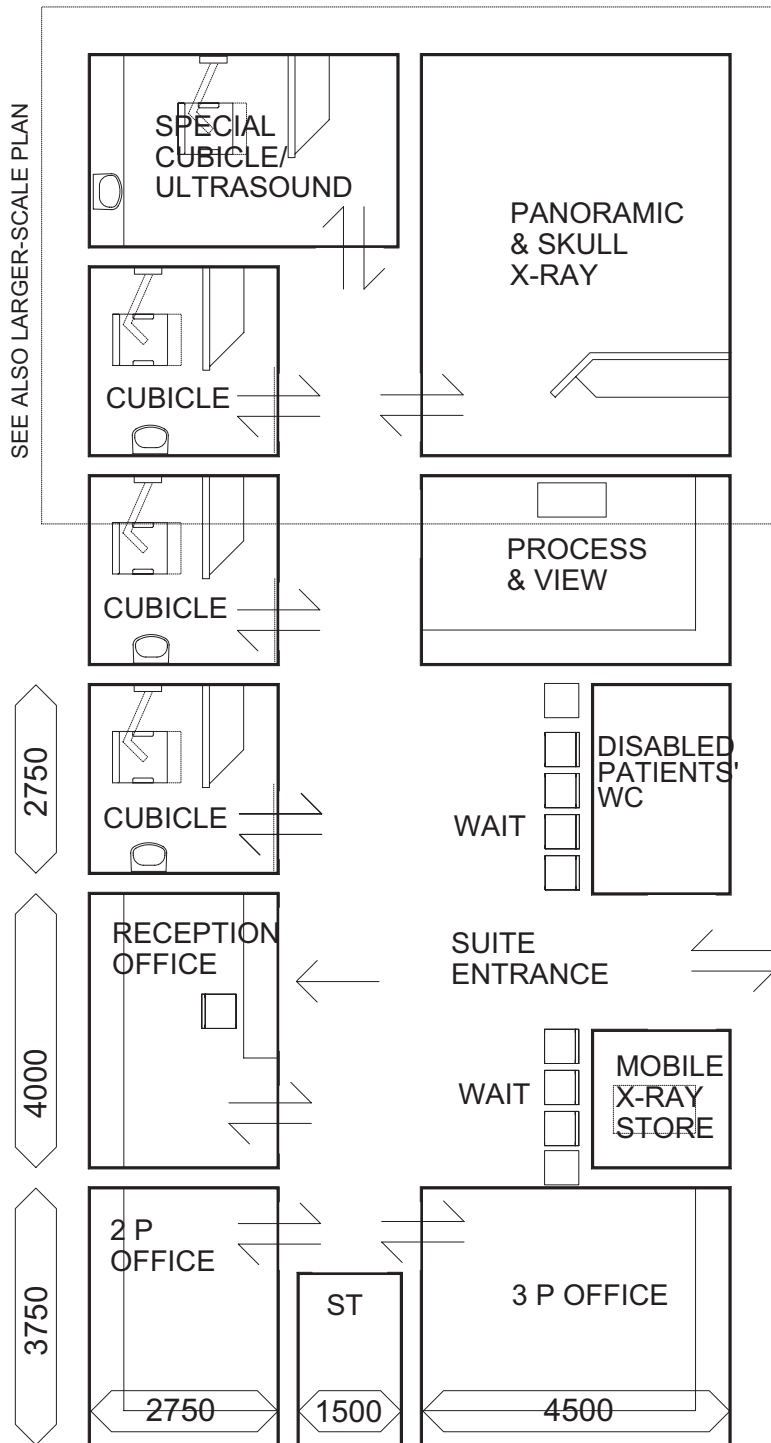
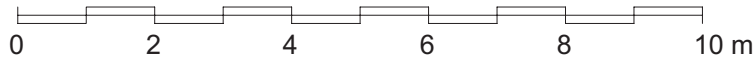

Note: this generic plan emphasises room layouts and adjacencies. It does **not** allow for other specific design requirements such as fire safety planning. Project and design teams must additionally consider such design factors, and adapt the generic plan accordingly.

DENTAL DIAGNOSTIC IMAGING: EXAMINATION ROOMS

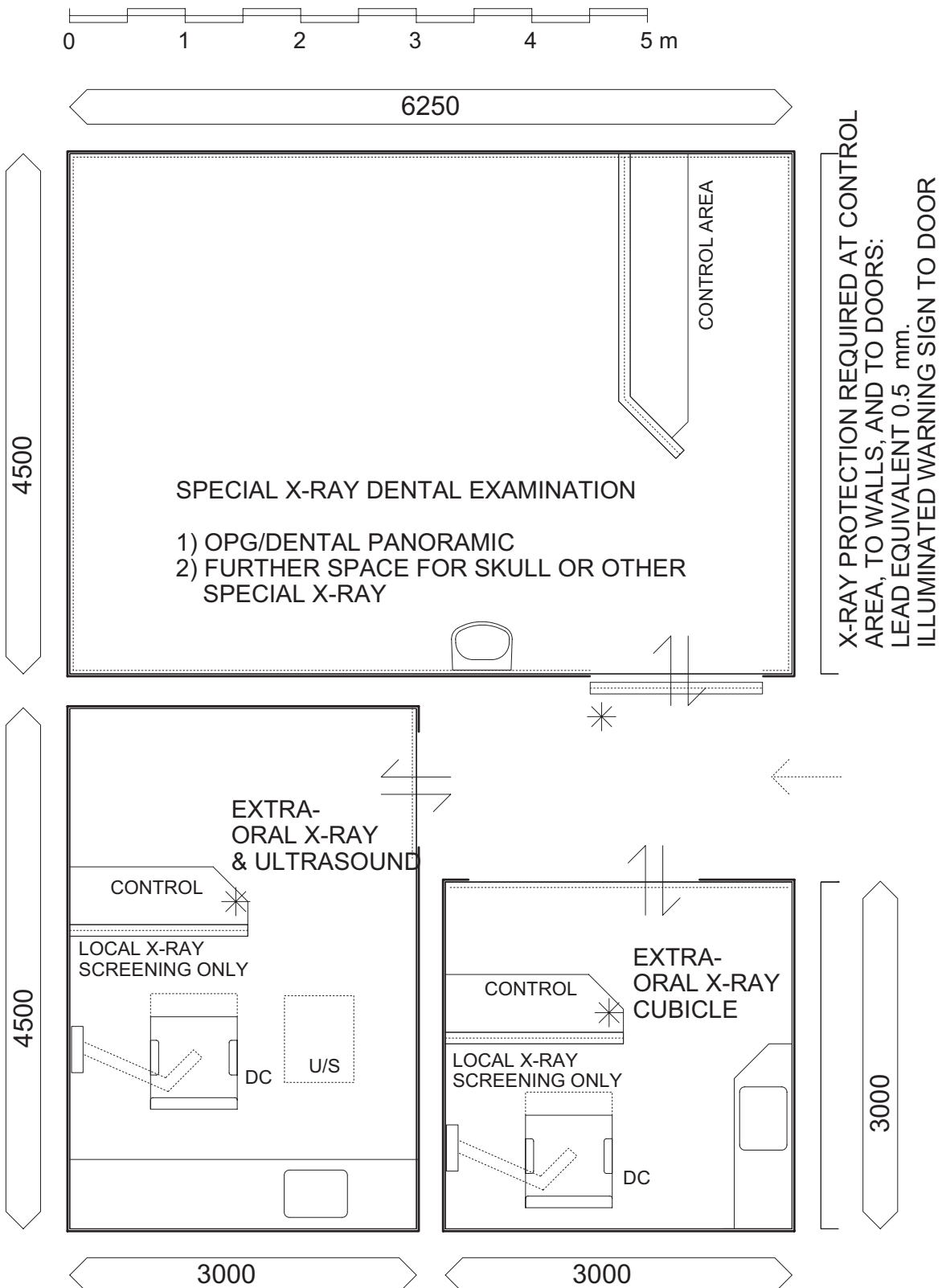

INTERVENTIONAL MRI SUITE: INDICATIVE ROOM RELATIONSHIPS

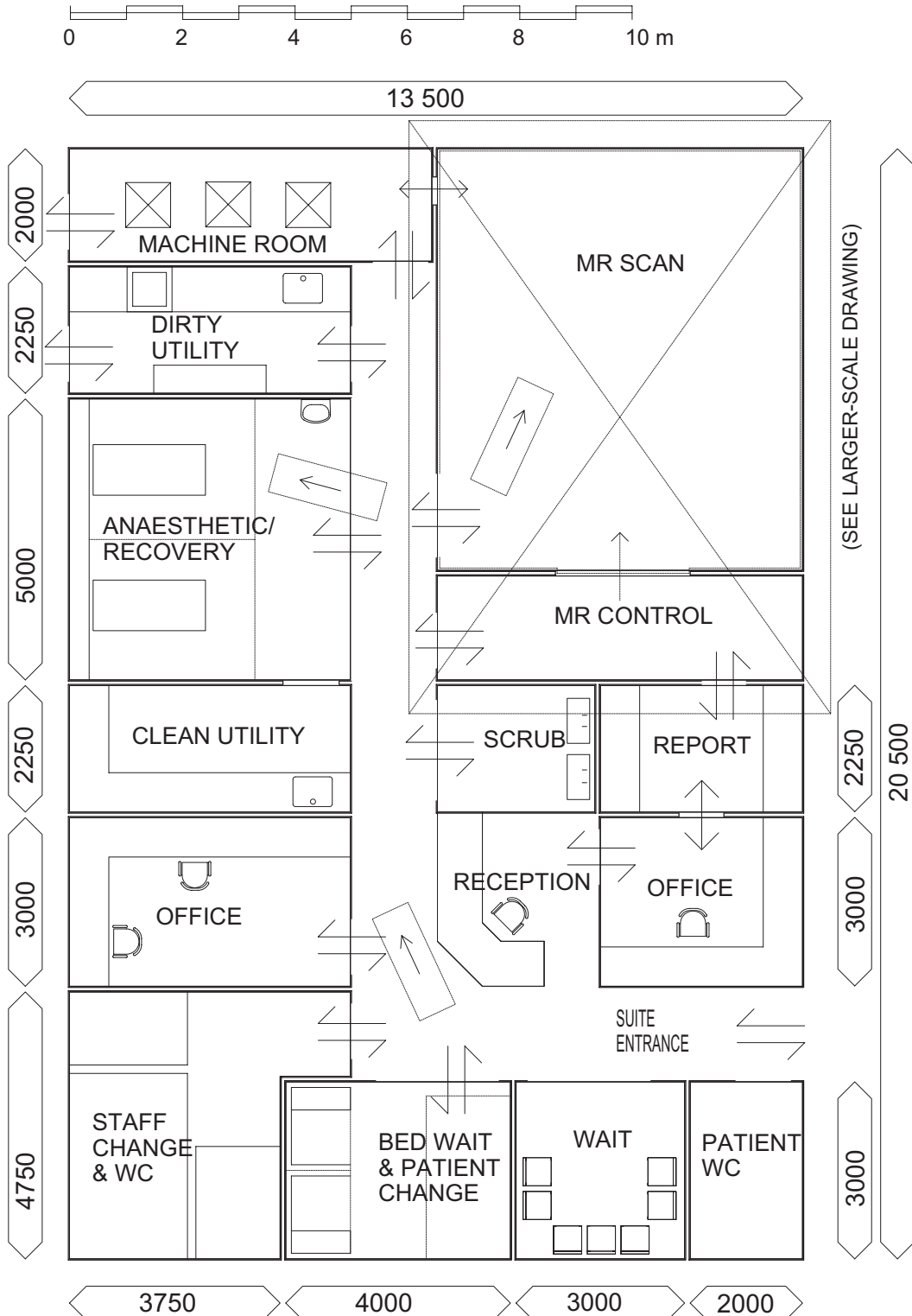

Note: this generic plan emphasises room layouts and adjacencies. It does **not** allow for other specific design requirements such as fire safety planning. Project and design teams must additionally consider such design factors, and adapt the generic plan accordingly.

INTERVENTIONAL MRI: MR SCAN & CONTROL ROOMS

(INDICATIVE
MR SCAN
ROOM AREA)

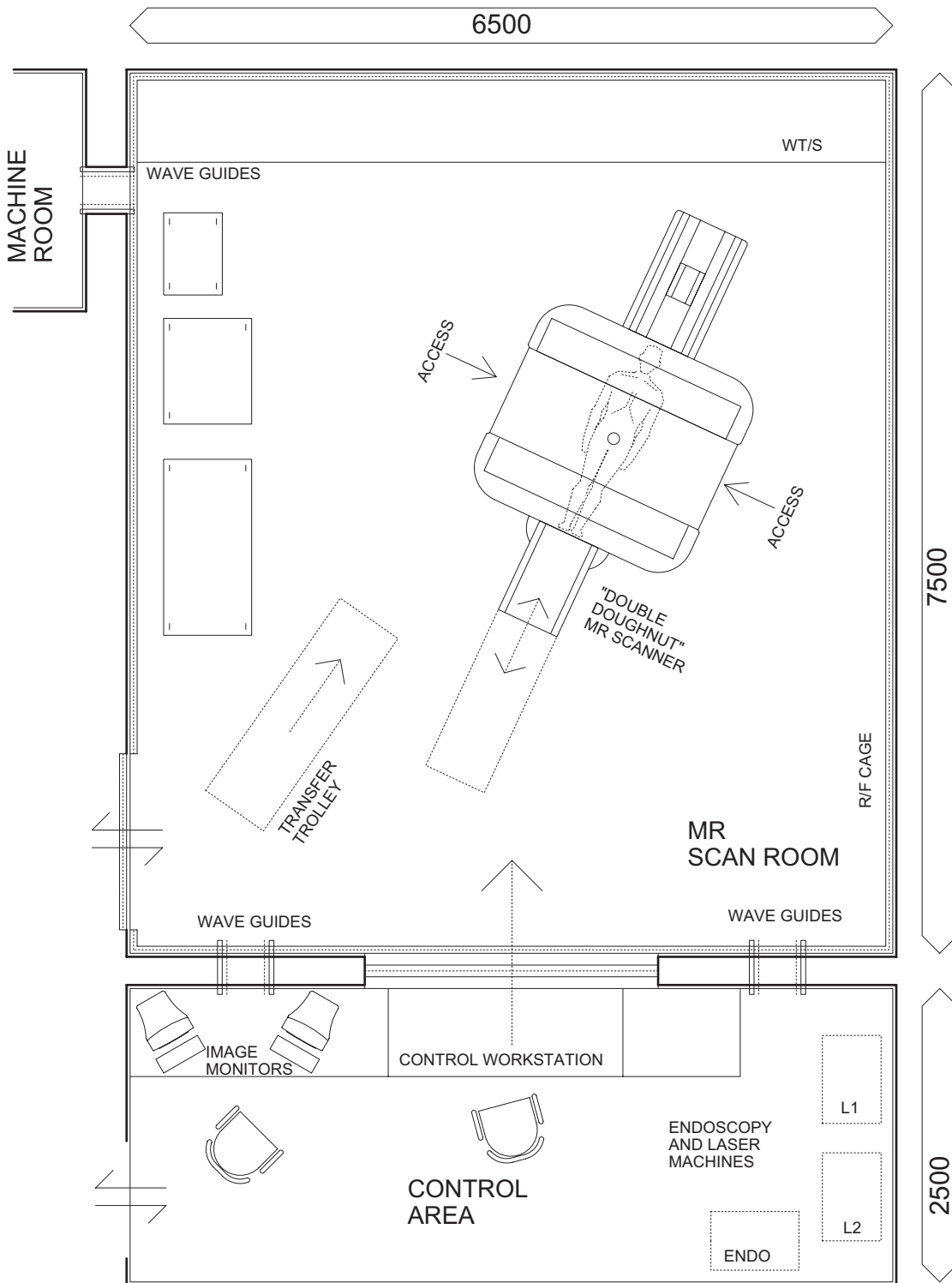
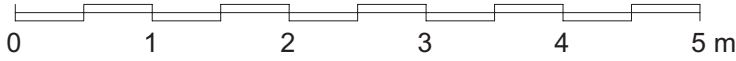

Glossary of terms and acronyms

ACR – American College of Radiology

An organisation of radiology healthcare professionals in the USA promoting high standards in further education, performance of examinations and advice on the implementation of new technologies. The college membership includes radiologists, radiation oncologists and clinical medical physicists.

A&E – Accident and emergency department

A hospital department treating patients who have had unforeseen injuries, in some cases life-threatening trauma.

ANSI – American National Standards Institute

Alzheimer's disease

Alzheimer's disease is a progressive form of dementia occurring in middle to late adult life. It is associated with diffuse degeneration of the brain and irreversible decline of memory and various cognitive functions.

Angioplasty

Angioplasty is a surgical technique used to widen or re-open a narrowed or blocked vessel or heart valve. A small, strong, deflated balloon constructed within the end of a small catheter is inserted into the affected area, under fluoroscopic X-ray control, and then inflated to clear the obstruction.

Arteriovenous malformation (AVM)

Arteriovenous malformation is a knot of distended blood vessels overlying and compressing the surface of the brain.

BIR – British Institute of Radiology

An accredited, charitable and learned body for all healthcare professionals working in, or affiliated to, the medical areas of radiology and radiotherapy.

BMD – Bone mineral density

Bone mineral density (BMD) relates to the strength and overall density of the bones. A patient with low bone density may have a disorder such as osteoporosis, whereby he or she may be at a higher risk of fracture.

CCD – Charge-coupled device

A CCD is a semiconductor device that can store charge in local areas. On an appropriate signal from the outside, the charge is transferred to a readout point.

CCTV – Closed Circuit Television

Cephalostat

A cephalostat is an attachment for a dental panoramic unit that allows the user to undertake digital X-ray images of the skull for lateral, posterior-lateral or anterior-lateral views.

Cerebrovascular embolism

A cerebrovascular embolism is an obstruction in the blood vessels of the brain. The inadequate blood supply to the brain may then result in a stroke or cerebral vascular incident.

Clean room

A clean room is an ultra-clean (aseptic) facility, in which the air is filtered and the facility operates at positive pressure. Such a facility may be used for the preparation of patient prescriptive injections.

CR – Computed radiography

An X-ray technique that utilises photostimulated phosphor plates to provide diagnostic quality images.

CSAG – Clinical Standards Advisory Group

CT – Computed tomography

Computed tomography (CT) is an X-ray imaging technique that generates cross-sectional images of the human anatomy. This method measures the transmission of X-rays around the body. The data is collected by a set of detectors and reconstructed to form a two-dimensional image.

Cyclotron

An item of equipment used for the production of radioactive isotopes, which are used in positron emission tomography (PET) imaging.

Data compression ratio

A compression ratio is the data size of an original, or uncompressed, image divided by the size of the compressed data. A compression ratio of 2.2 is sometimes called “loss-less” compression, which means none of the diagnostically significant data is lost when it is compressed, decompressed and then viewed on a workstation monitor. Compression ratios greater than 2.2 lose some data in the process and may make images unsuitable for diagnostic interpretation.

Dementia

Dementia is a chronic disorder of the mental processes due to pathological changes in the brain. The disorder is typically marked by memory loss and changes in personality. The problems associated with dementia are most commonly seen in the elderly.

DEXA – Dual energy X-ray absorptiometry

DEXA DXA utilises two X-ray energies in identifying the bony constituent from the surrounding soft tissue in a patient. This is undertaken in order to ascertain whether the subject has low BMD, and thus may have an osteoporotic disorder.

DGH – District general hospital**DICOM – Digital imaging and communications in medicine**

The DICOM standard has been developed jointly by the American College of Radiology (ACR) and the National Electrical Manufacturers’ Association (NEMA) as a standard method for transferring images and associated information between devices manufactured by various vendors.

DR – Direct radiography

An X-ray technique that permits digital images to be directly acquired, processed and displayed using a solid-state detector integrated into the X-ray system.

Endocrinology

Endocrinology is the physiological study of the endocrine system and the substances that are secreted by organs such as the thyroid, pituitary and adrenal glands. The endocrine glands manufacture and secrete hormones and other chemicals directly into the bloodstream which then, either directly or indirectly, regulate discrete and interdependent physiological activities.

EPR – Electronic patient record

An electronic patient record is a folder held on a hospital computer system. It may contain a patient’s biographical information, scan/examination reports, scan images, or schedule or clinic appointments. The record only pertains to investigations and other clinical treatments undertaken at the hospital concerned.

Extra-oral X-ray

Extra-oral X-ray examinations utilise single-use small films in disposable covers and intensifying screens. They are not placed in conventional cassettes. These are typically mounted on specialised film holders, which are held in position by the patient’s teeth. The X-ray tube is then placed outside the patient’s jaw diametrically opposed to the X-ray film.

FDG – Fluorodeoxyglucose, ¹⁸F

Fluorodeoxyglucose (¹⁸F) is a radioactive compound used in positron emission tomography (PET) studies which is commonly used to investigate the presence of metastases or secondaries in various forms of cancer. The compound metabolises faster in areas where there is high uptake or use of glucose.

fMRI – Functional magnetic resonance imaging

Pertains to imaging of the brain. Functional imaging relies on local physiological changes in the brain associated with activation of one of the sensory systems.

Gamma camera

The gamma camera is the most common imaging device used in a radionuclide imaging facility. The gamma camera provides dynamic (for example heart function) and static (for example skeletal) images of the patient following the introduction of a radioactive agent into the patient’s system.

Gamma knife

A gamma knife is an instrument, used in stereotactic radio-surgery on the brain, that emits a highly controllable beam of radiation to destroy a brain tumour whilst having minimal effect on surrounding tissues. As the name suggests, the technique utilises ionising radiation, and facilities should be designed accordingly.

HEPA – High efficiency particulate air (filter)

The type of filter most frequently used in clean-room facilities. The filter is designed to remove even the small particles, in some cases less than 1 mm, from the air.

HIMSS – Healthcare Information and Management Systems Society

HIS – Hospital information system

The hospital information system is a hospital-wide networked computing system which permits the archiving and communication of multimedia information relating to the care of both in- and out-patients.

HL7 – Health Level 7

HL7 is an agreed international standard for the transfer of text-based data, such as pathology and radiology reports, between devices and different information systems. The standard also covers the transfer of patient demographic information between different information systems. There are a number of common elements between the HL7 and DICOM standards.

IEE – Institute of Electrical Engineers

A UK accredited and professional body for electrical engineers, electricians and scientists. Also provides coherent reference and policy documentation pertaining to the profession and the development of standards.

IHE – Integrating Healthcare Enterprise

IMS – Image management system

Manages, stores and transfers images and information between the diagnostic modalities, radiological reporting systems and other IT systems such as HIS and RIS. The basic functions of an IMS are listed below:

- management of images on archives. The IMS will receive all the digital images that are acquired at each of the modalities within the department and store these within the appropriate location on the digital archives. This may include modalities that are operating at remote locations;
- automatically moving the images to the appropriate locations within an archive as they become older, according to a set of instructions configured when the system is commissioned;
- communicating the images to different parts of the radiology department, for example for reporting and review. In some cases, the information transfer may be undertaken automatically or semi-automatically with little or no manual intervention;
- moving images to other areas of the hospital or trust for review by responsible clinicians. This may be undertaken in conjunction with a web-based export server and RIS;
- producing hard copies of images acquired and stored digitally, through a direct connection with a laser printer;

- allowing images to be distributed to other centres and hospitals through the use of teleradiology links.

Intra-arterial infusion

A slow injection of a solution (for example saline) directly into the artery.

IPG – Information policy group

A Department of Health policy and strategic initiative and group, which covers the use of information technology in healthcare reforms and patient improvements.

Maxillo-facial surgery

A dental specialty that provides diagnosis and surgical treatment with respect to pathologies of the jaw, oral cavity and other associated structures.

MDA – Medical Devices Agency

A Government agency which provides advice and guidance documents on technical aspects of medical equipment. The organisation also has a programme of evaluating medical equipment and notifying users following the advent of a major technical equipment failure.

MPI – master patient index

MRI – Magnetic resonance imaging

A non-invasive method for generating two- and three-dimensional images of the human anatomy by measuring the environment and location of water in the body's tissue and fats etc. The technique can show great sensitivity and specificity in differentiating between diseased and normal tissues.

MRS – Magnetic resonance spectroscopy

This technique can generate images based on the chemical make-up and environment experienced by different species of atoms such as hydrogen or phosphorus. The technique is commonly used in the brain to look for certain types of pathologies. A number of 1.5 T MRI scanners commercially available can be readily equipped with facilities to undertake MR spectroscopic examinations or investigations.

Myelography

An X-ray examination of the spinal cord utilising iodinated contrast media. Useful in discerning or diagnosing spinal tumours or other conditions which may compress or affect the function of the spine or spinal cord.

NEMA – National Electrical Manufacturers' Association

A US professional association for manufacturers which evaluates and assists in setting and implementing standards and guidance for the installation and use of a broad range of electrical devices (including medical equipment) and the infrastructure that supports electricity distribution.

NIH – National Institute of Health

The NIH is an agency of the United States Public Health Services of the US Department of Health and Human Services. The Institute provides support for biomedical research and training for health researchers, and disseminates medical information primarily via its website.

OPG – Orthopantomograph

An example of an X-ray image acquired using a dental panoramic/OPG dental X-ray unit is shown below.



Orthodontic treatment

A division of dentistry dealing with the process of correcting teeth deformities and irregularities, usually by means of a dental appliance (for example a brace) acting directly on the teeth.

PACS – Picture archive and communication system

PAR – Post-anaesthesia recovery

The hospital area where the patient is observed following surgery, and where the effects of anaesthesia are monitored.

Parkinson's disease

A disorder commonly affecting middle-aged and elderly people, characterised by tremors, rigidity and spontaneous movement. The disease causes a severe progressive marked degeneration of parts of the nervous system.

PAS – Patient administration system

PaSA – NHS Purchasing and Supply Agency

A Government agency which acts as a centre of expertise and knowledge in the procurement of supplies for the National Health Service. The agency provides advice on policy and strategic direction of procurement and its impact on developing healthcare.

Periodontal treatment

Dental treatment and investigations related to the gums and other soft tissues of the oral cavity.

PET – Positron emission tomography

See Volume 1 of this guidance for a full description.

PFI – Private finance initiative

PPP – Public-private partnership

RAID – Redundant array of inexpensive disks

A resilient multi-disk array or digital archive commonly used for the storage of critical data, that can be configured to allow for fast access by multiple users. Single items of information are stored across multiple disks in a manner that allows recovery of data on one or more disks in the event of a failure. In PACS the device is commonly used as short-term archive for images that have been acquired between 1 and 4 weeks previously, as these are most frequently accessed by the users.

Radionuclide imaging

A method whereby a gamma-emitting radiopharmaceutical is introduced into the human body or, in the majority of cases, by means of intravenous injection, and the resulting distribution is imaged by recording the radiation emitted using a gamma camera. The radiopharmaceutical targets the specific organs which are of interest.

RCR – Royal College of Radiologists

The accredited professional body for all clinical radiologists and allied professionals working in the medical specialty of radiology.

Respiratory medicine

A clinical department which studies and treats patients who may have breathing and/or an associated lung/nasal disorder.

RIS – Radiology information system

An electronic archive and computer server system which stores text-based data on patients who have undergone, or who are about to undergo, a radiological procedure or examination. Works in tandem with an IMS

to allow authorised users access to information related to the care of patients and maintain the efficient operation of a department.

The primary functions performed by a RIS include:

- maintaining an electronic database of all patients who have undergone, or are about to undergo, an imaging or interventional procedure within the hospital. This may include studies undertaken outside the main diagnostic imaging department;
- enabling electronic reporting of examinations utilising templates (for example word-processing templates) or Voice Activated Recognition (VAR) word processing systems;
- storing data on patients, such as completed radiological reports, data from request forms, and a history of examinations or procedures undertaken;
- working with other hospital-based IT systems to provide electronic request forms for referring clinicians inside and outside the hospital environment;
- allowing manual, semi- and fully-automatic scheduling of examinations across multiple facilities and procedure rooms. Where possible, work-lists of patients, including their full demographics, should be transmitted to each of the modality consoles before the commencement of a clinical working session;
- assisting with staff management within the radiology department;
- maintaining a record of the hospital's local rules, procedures, guidelines and emergency procedures.

RPA – Radiation protection advisor

A person employed by a hospital or other institute which uses radiation in an industrial or medical field. The RPA advises on matters related to radiation, so that staff and patients who work or are treated at the facility do so in a safe environment. All matters pertaining to the safe delivery of radiation to the patient and the appropriate shielding of both patient and staff are considered by the RPA, operating under the guidance of the Ionising Radiation (Medical Exposure) Regulations. The RPA must be consulted when any radiation equipment is being installed or moved in a facility or on any matters pertaining to ionising radiation.

RSNA – Radiological Society of North America

A prominent learned US society that supports and assists in the education of radiology healthcare professionals. The society publishes the 'Radiographics' and 'Radiology' learned journals and also set up the IHE framework.

Sialography

An X-ray examination of the salivary glands following the introduction of a contrast agent into the ducts of these glands in the mouth.

SPECT – Single photon emission computer tomography

An imaging technique using a gamma camera, that provides two- and three-dimensional images of the distribution of a radioactive compound in the patient's body.

Teleradiology

A teleradiology facility allows the export of patient images and other radiological data to other remote clinical sites, for example the distribution of radiological images to a tertiary referral centre from a general acute hospital for further consultation and opinion.

Trabecular bone

The trabecular bone is the spongy constituent of bone found beneath the compact bone. It consists of an irregular latticework of thin plates of bone called trabeculae, other types of bone cell, and in some cases red bone marrow.

UPS – Uninterruptible power supply

A battery back-up device which provides critical devices with a smooth continuous power supply. For some types of medical equipment the UPS can help reduce occurrences of failure during the transient period between the failure of the mains power supply and start-up of the emergency supply.

UTP – Unshielded twisted pair

A standard type of communication cabling that is used in data/voice transmission systems.

V-LAN – Virtual local area network

A V-LAN controller provides routing control and bandwidth optimisation within a data network and ensures that the network does not become overloaded. The system can protect against failure from segments of the network and provides a means of gaining secure access to a network or system for remote users.

Wada test

The Wada test (named after neurologist Dr Juhn Wada, its originator) is part of the presurgical evaluation of a patient who may undergo surgery for epilepsy. A thin plastic tube (catheter) is inserted into an artery at the groin and threaded into other arteries leading to the brain. The short-acting anaesthetic agent sodium amobarbital is injected into an internal carotid artery (the

large artery on the side of the neck going to the brain), thus putting that side of the brain "to sleep". The patient's ability to speak, understand speech, and remember things is then evaluated. After the drug effect has worn off, the process is repeated with the other hemisphere.

The Wada test requires brief hospitalization. It helps to determine which cerebral hemisphere is "dominant" for speech and if memory is functional on one or both sides of the brain. If the seizures are coming from the non-dominant hemisphere, this test may not be needed.

WHO – World Health Organisation

Provides advice, assistance and policies on matters related to health in a local, national and global situation.

References

LEGISLATION

Consumer Protection Act 1987. The Stationery Office, 1987.

Disability Discrimination Act 1995. The Stationery Office, 1995.

(http://www.legislation.hmso.gov.uk/acts/acts1995/Ukpga_19950050_en_1.htm)

Health and Safety at Work etc Act 1974. The Stationery Office, 1974.

Radioactive Substances Act 1993. The Stationery Office, 1993.

(http://www.legislation.hmso.gov.uk/acts/acts1993/Ukpga_19930012_en_1.htm)

SI 1996: 2092 The Carriage of Dangerous Goods (Classification, Packaging and Labelling) and Use of Transportable Pressure Receptacles Regulations. The Stationery Office, 1996.

(http://www.legislation.hmso.gov.uk/si/si1996/Uksi_19962092_en_1.htm)

SI 1994/3140 The Construction (Design and Management) Regulations. The Stationery Office, 1994.

(http://www.legislation.hmso.gov.uk/si/si1994/Uksi_19943140_en_1.htm)

SI 2000: 2380 The Construction (Design and Management) (Amendment) Regulations. The Stationery Office, 2000.

(<http://www.legislation.hmso.gov.uk/si/si2000/20002380.htm>)

SI 1999: 437 The Control of Substances Hazardous to Health Regulations (COSHH). The Stationery Office, 1999.

(<http://www.hmso.gov.uk/si/si1999/19990437.htm>)

SI 1992: 2372 The Electromagnetic Compatibility Regulations. The Stationery Office, 1992.

(http://www.hmso.gov.uk/si/si1992/Uksi_19922372_en_1.htm)

SI 1992: 2792 Health and Safety (Display Screen Equipment) Regulations. The Stationery Office, 1992.

(http://www.legislation.hmso.gov.uk/si/si1992/Uksi_19922792_en_1.htm)

SI 1999: 3232 The Ionising Radiations Regulations. The Stationery Office, 1999.

(<http://www.legislation.hmso.gov.uk/si/si1999/19993232.htm>)

SI 2000: 1059 The Ionising Radiation (Medical Exposure) Regulations. The Stationery Office, 2000.

(<http://www.legislation.hmso.gov.uk/si/si2000/20001059.htm>)

SI 1999: 3242 The Management of Health and Safety at Work Regulations. The Stationery Office, 1999.

(<http://www.legislation.hmso.gov.uk/si/si1999/19993242.htm>)

SI 1998: 2306 The Provision and Use of Work Equipment Regulations. The Stationery Office, 1998.

(<http://www.hmso.gov.uk/si/si1998/19982306.htm>)

SI 1996: 1350 The Radioactive Material (Road Transport) (Great Britain) Regulations. The Stationery Office, 1996.

(http://www.hmso.gov.uk/si/si1996/Uksi_19961350_en_1.htm)

SI 1992: The Workplace (Health, Safety and Welfare) Regulations. The Stationery Office, 1992.

(http://www.hmso.gov.uk/si/si1992/Uksi_19923004_en_1.htm)

NHS ESTATES PUBLICATIONS

Firecode: Fire risk assessment in Nucleus hospitals. The Stationery Office, 1997.

Infection control in the built environment: design and planning. The Stationery Office, 2002.

Firecode: Policy and principles. The Stationery Office, 1994.

“Safe” hot water and surface temperatures (Health Guidance Note). The Stationery Office, 1998.

Strategic guide to combined heat and power. The Stationery Office, 1993.

Facilities for cancer care centres. The Stationery Office, 2001.

Health Building Notes

HBN 6 Facilities for diagnostic imaging and interventional radiology – Volume 1. The Stationery Office, 2001.

HBN 18 Office accommodation in health buildings. The Stationery Office, 1991.

HBN 22 Accident and emergency facilities for adults and children. The Stationery Office, 2002.

HBN 26 Operating department. The Stationery Office, 1991 (under review).

HBN 29 Accommodation for pharmaceutical services. The Stationery Office, 1997.

HBN 40 Common activity spaces. The Stationery Office, 1995.

Vol 1: Public areas.

Vol 2: Treatment areas.

Vol 3: Staff areas.

Vol 4: Circulation areas.

HBN 48 Telephone services. The Stationery Office, 1997.

Health Technical Memoranda (HTMs)

HTM 57 Internal glazing. The Stationery Office, 1994.

HTM 58 Internal doorsets. The Stationery Office, 1998.

HTM 59 Ironmongery. The Stationery Office, 1998.

HTM 60 Ceilings. The Stationery Office, 1989.

HTM 63 Fitted storage systems. The Stationery Office, 1989.

HTM 81 Fire precautions in new hospitals. The Stationery Office, 1996.
(<http://www.nhsestates.gov.uk/download/htm81.pdf>)

HTM 82 Alarm and detection systems. The Stationery Office, 1996.
(<http://www.nhsestates.gov.uk/download/htm82.pdf>)

HTM 83 Fire safety in healthcare premises – general fire precautions. The Stationery Office, 1994.
(<http://www.nhsestates.gov.uk/download/htm83.pdf>)

HTM 85 Fire precautions in existing hospitals. The Stationery Office, 1994.
(<http://www.nhsestates.gov.uk/download/htm85.pdf>)

HTM 86 Fire risk assessment in hospitals. The Stationery Office, 1994.
(<http://www.nhsestates.gov.uk/download/htm86.pdf>)

HTM 87 Textiles and furniture. The Stationery Office, 1999.
(<http://www.nhsestates.gov.uk/download/htm87.pdf>)

HTM 88 Fire precautions in housing providing NHS-supported living in the community. The Stationery Office, 2001.
(<http://www.nhsestates.gov.uk/download/htm88.pdf>)

HTM 2005 Building management systems. The Stationery Office, 1996.

Management policy.

Design considerations.

Validation and verification.

Operational management.

HTM 2007 Electrical services supply and distribution. The Stationery Office, 1993.

Management policy.

Design considerations.

Validation and verification.

Operational management.

HTM 2011 Emergency electrical services. The Stationery Office, 1993.

Management policy.

Design considerations.

Validation and verification.

Operational management.

HTM 2014 Abatement of electrical interference. The Stationery Office, 1993.

Management policy.

Design considerations.

Validation and verification.

Operational management.

HTM 2015 Bedhead services. The Stationery Office, 1994.

Management policy.

Design considerations.

Validation and verification/operational management.

HTM 2022 Medical gas pipeline systems. The Stationery Office, 1997.

Design, installation, validation and verification.

Operational management.

HTM 2023 Access and accommodation for engineering services. The Stationery Office, 1995.

Management policy.

Good practice guide.

HTM 2025 Ventilation in healthcare premises. The Stationery Office, 1994.

Management policy.

Design considerations.

Validation and verification.

Operational management.

HTM 2027 Hot and cold water supply, storage and mains services. The Stationery Office, 1995.

Management policy.

Design considerations.

Validation and verification.

Operational management.

HTM 2045 Acoustics. The Stationery Office, 1996.

Management policy.

Design considerations.

Validation and verification/operational management.

Audiology.

HTM 2055 Telecommunications (telephone exchanges). The Stationery Office, 1994.

Management policy.

Design considerations.

Validation and verification.

Operational management.

DEPARTMENT OF HEALTH PUBLICATIONS

Capital investment manual. NHS Executive, The Stationery Office, 1994.

Overview.

Project organisation.

Private finance guide.

Business case guide.

Management of construction projects.

Commissioning a health care facility.

IM&T guidance.

Post-project evaluation.

Guidance on the application of the minimum ergonomic working standards for personnel engaged in the preparation, scanning and reporting of cervical screening slides (Addendum to MDA/97/31) Sep-97MDA/97/31S NCSP. Medical Devices Agency, 1997.

Guidelines for magnetic resonance diagnostic equipment in clinical use with particular reference to safety. Medical Devices Agency, Department of Health, 1993.

Health building and estate management: building legislation compliance procedures (HC(88)60). Department of Health, 1988.

Information for health – an information strategy for health 1998–2005. Department of Health, 1998. (<http://www.doh.gov.uk/ipu/strategy>)

Mobile phones and health. Independent Expert Group on Mobile Phones, Department of Health, 2000. (<http://www.iegmp.org.uk/>)

National service framework for coronary heart disease: modern standards and service models. Department of Health, 2000. (<http://www.doh.gov.uk/nsf/coronary.htm>)

The New NHS: modern, dependable. Department of Health, The Stationery Office, 1997. (<http://www.official-documents.co.uk/document/doh/newnhs/newnhs.htm>)

The NHS Plan. Department of Health, The Stationery Office, 2000. (<http://www.doh.gov.uk/nhsplan/default.htm>)

Technical requirements for the supply and installation of equipment for diagnostic imaging and radiotherapy (TRS89). Medical Devices Agency, Department of Health, 1989.

BRITISH STANDARDS

BS 2881: 1989 Specification for cupboards for the storage of medicines in healthcare premises. British Standards Institute, 1989. (Confirmed 1994).

BS 4533 Luminaires. British Standards Institution (produced in various sections).

BS 4533-102.55: 1986 Luminaires. Particular requirements. Specification for luminaires for hospitals and health care buildings. Partially replaced by **BSEN 60598-2-25:1995 Luminaires. Particular requirements. Luminaires for use in clinical areas of hospitals and health care buildings.** British Standards Institute, 1986/95.

BS 4533-103.2: 1986 Luminaires. Performance requirements. Specification for photometric characteristics of luminaires for hospitals and healthcare buildings. British Standards Institute, 1986.

BS 5266-1: 1999 Emergency lighting. Code of practice for the emergency lighting of premises other than cinemas and certain other specified premises used for entertainment. British Standards Institute, 1999.

BS 6651: 1999 Code of practice for protection of structures against lightning. British Standards Institution, 1999.

BS 7671: 2001 Requirements for electrical installations. IEE Wiring Regulations. 16th Edition. With amendments: AMD 13628 published February 2002.

BS EN 740: 1999. Anaesthetic workstations and their modules. Particular requirements. British Standards Institution, 1999.

BS EN 12056-2: 2000 Gravity drainage systems inside buildings. Sanitary pipework, layout and calculation. British Standards Institution, 2000.

BS EN 55015: 2001 Limits and methods of measurement of radio disturbance characteristics of electrical lighting and similar equipment. British Standards Institution, 2001.

BS EN 60601-1-2: 2002 Medical electrical equipment. General requirements for safety. Collateral standard. Electromagnetic compatibility. Requirements and tests. British Standards Institution, 2002.

BS EN ISO 14644-4:2001 Cleanrooms and associated controlled environments. Design, construction and start-up. British Standards Institution, 2001. Guidance note 7: special locations. Institution of Electrical Engineers, 1998.

OTHER PUBLICATIONS

Air distribution systems (CCA). The Chartered Institution of Building Services Engineers (CIBSE), 1996.

Guidance to engineering commissioning. Institute of Healthcare Engineering and Estate Management, 1995.

Justification in radiation protection. British Institute of Radiology, 1998.
(<http://www.bir.org.uk>)

Lighting guide: Hospital and health care buildings (LG2). Chartered Institution of Building Services Engineers(CIBSE), 1989 (under review).

Making the best use of a department of clinical radiology. Guidelines for doctors. Fourth edition. Royal College of Radiologists, 1998.
(<http://www.rcr.ac.uk>)

Notes on building materials and references on shielding data for use below 300kVp (Report 41). Institute of Physics and Engineering in Medicine, 1984 (reprint).
(<http://www.ipem.org.uk>)

Occupational exposure limits (EH40). Health and Safety Executive, HSE Books, issued annually.

Public health engineering (GVG). The Chartered Institution of Building Services Engineers (CIBSE), 1999.

Radiation shielding for diagnostic X-rays. British Institute of Radiology, 2000.
(<http://www.bir.org.uk>)

Retention of X-ray films: résumé of the issues. Royal College of Radiologists, 1991.
(<http://www.rcr.ac.uk>)

The visual environment for display screen use (LG03). The Chartered Institution of Building Services Engineers (CIBSE), 1996.

Water distribution systems (CCW). The Chartered Institution of Building Services Engineers (CIBSE), 1994.

Work with ionising radiation: Ionising Radiations Regulations 1999: approved code of practice and guidance. Health and Safety Commission, HSE Books, 2000.

BONE MINERAL DENSITY (BMD) SECTION

Assessment of fracture risk and its application to screening for postmenopausal osteoporosis. WHO Technical Report Series 843.

Osteoporosis: Clinical guidelines for prevention and treatment. Royal College of Physicians & Bone and Tooth Society, 2000.

Clinical guidelines in osteoporosis. Chartered Society of Physiotherapy and National Osteoporosis Society, 2000.

NEURO-RADIOLOGY SECTION

Bristol Royal Infirmary enquiry final report.

National service framework for older people.

Department of Health, 2001.

(<http://www.doh.gov.uk/nsf/pdfs/nsfolderpeople.pdf>)

Board of Faculty of Clinical Radiology. Clinical Radiology – a workforce in crisis. The Royal College of Radiologists, 2002. RCR Ref No BFCR (02)1.

Clinical Standards Advisory Group (CSAG); Services for patients with epilepsy. Parts 1 and 2.

Report of a CSAG committee chaired by Professor Alison Kitson, and prepared by Professor Simon Shorvon et al, 1999.

(<http://tap.ccta.gov.uk/doh/point.nsf/>)

Advice on the 1998 ICNIRP guidelines for limiting exposure to time-varying electric, magnetic and electromagnetic fields (up to 300 GHz). Documents of the NRPB, Vol 10 No 2, 1999.

PACS SECTION

Guide to Information Technology in Radiology: Teleradiology and PACS. Second Edition. The Royal College of Radiologists, 2000. RCR Ref No BFCR(00)4.

Radiology Information Systems Board of Faculty of Clinical Radiology. The Royal College of Radiologists, 2000. RCR Ref No BFCR(00)8.

Tim Chunn, BSME, MBA, *Medical image digital archive – A comparison of storage technologies*, in Lemke, HU, Vannier, MW, Inamura, K and Farman, AG, Eds, **Computed Assisted Radiology and Surgery**, Proceedings of the 12th International Symposium and Exhibition – CARS 98, pp 314–319.

Bryan, S, Weatherburn, GC, Watkins, JR and Buxton, MJ, *The benefits of hospital wide picture archiving and communication systems: A survey of clinical users of radiology systems*, **British Journal of Radiology**, Vol 72, 1999, pp 469–478.

Maass, M, Kosonen, M and Kormano, M, *Cost analysis of Turku University Central Hospital PACS in 1998*, **Comput Methods Programs Biomed**, July 2001, 66(1), pp 41–50.

Procurement of Information Solutions Effectively (POISE), Third Edition, February 2002.

Reed, G and Smith, EM, *Planning for a multi-imaging centre picture archiving and communications system*, **J Digit Imaging**, June 2001, 14(2 Suppl 1), pp 9–11.

Lewin, JM, Hendrick, RE, D'Orsi, CJ, Isaacs, PK, Moss, LJ, Karellas, A, Sisney, GA, Kuni, CC and Cutter, GR, *Comparison of full-field digital mammography with screen-film mammography for cancer detection: results of 4,945 paired examinations*, **Radiology**, March 2001, 218(3), pp 873–880.

Hospital Activity Data on Imaging and Radiodiagnostics.

(http://www.doh.gov.uk/hospitalactivity/statistics/1999-00/imaging_and_radiodiagnostics/y00.htm)

Wuang, HR and Liss, W, **PACS Basic Principles and Applications**, 1999.